



Reference Manual

Revised: 6/18/2014

<http://www.carlsonsw.com>

<http://survce.com>



© Carlson Software, 2014

Table of Contents

End-User License Agreement	6
Installation	11
Using the Manual	11
System Requirements	11
Microsoft ActiveSync	12
Installing SurvCE	15
Authorizing SurvCE	20
Hardware Notes	22
Color Screens	22
Memory	23
Battery Status	23
Save System	24
Carlson Technical Support	25
User Interface	26
Graphic Mode	26
View Options	29
Quick Calculator	30
Hot Keys & Hot List	32
Carlson Cloud	36
Instrument Selection	38
Input Box Controls	39
Keyboard Operation	42
Abbreviations	43
FILE	45
Job	45
Job Settings (New Job)	46
Job Settings (System)	48
Job Settings (Format)	50
Job Settings (Options)	51
Job Settings (Stake)	63
List Points	74
Raw Data	77
Feature Code List	88
Data Transfer	115
Import/Export	121
Delete File	127
Add Job Notes	128
Exit	129

EQUIP	130
Total Station	130
Total Station Prism Search by GPS	137
GPS Setup	140
GPS Base	146
GPS Rover	154
GPS Utilities	164
Configure (General)	166
Configure (View Pt)	174
Configure (Sets)	176
Localization	178
Monitor/SkyPlot (GPS)	195
Check Level (Total Station)	198
Tolerances	199
Peripherals	200
About SurvCE	205
SURV	207
Orientation (Instrument Setup)	207
Orientation (Backsight)	210
Orientation (Remote Benchmark)	212
Orientation (Advanced Occupation)	213
Orientation (Robotics)	225
Store Points (TS)	227
Store Points (TS Offsets)	232
Store Points (GPS)	235
Store Points (GPS Offsets)	240
Stake Points	245
Stake Line/Arc	259
Stake Offset	278
Elevation Difference	282
Grid/Face	288
Resection	291
Set Collection	296
Leveling	304
Auto By Interval	313
Remote Elevation	315
Log Raw GPS	316
COGO	334
Keyboard Input	334
Inverse	336
Areas	338

Intersections	339
Point Projection	344
Station Store	349
Transformation	351
Calculator	354
Manual Traverse	360
Point Average	363
ROAD	373
Centerline Editor	373
Draw Centerline	380
Profile Editor	380
Draw Profile	383
Template Editor	384
Draw Template	389
Utilities	389
Stake Slope	412
Store Sections	433
Stake Road	445
MAP	492
Basics	492
FILE	498
VIEW	520
DRAW	525
COGO	549
TOOLS	563
Tutorials	578
Tutorial 1: Calculating a Traverse (By Hand) with SurvCE	578
Tutorial 2: Performing Math Functions in Carlson SurvCE	580
Input Boxes	
Tutorial 3: Performing a Compass Rule Adjustment	580
Tutorial 4: Defining Field Codes, Line/Layer Properties &	585
GIS Prompting	
Tutorial 5: Standard Procedures for Conducting GPS	603
Localizations	
GPS Utilities by Manufacturer	613
GPS Utilities (Leica 500/1200)	613
GPS Utilities (Navcom)	615
GPS Utilities (Sokkia and Novatel)	620
GPS Utilities (Magellan/Ashtech)	621
GPS Utilities (Topcon)	625
GPS Utilities (Trimble)	625

Troubleshooting	626
GPS Heights	626
Handheld Hardware	626
Miscellaneous Instrument Configuration	628
Supported File Formats	629
Raw Data	631
File Format	631

End-User License Agreement

Copyright © 1992-2010 Carlson Software

All Rights Reserved

CAUTION! READ THIS NOTICE CAREFULLY BEFORE USING SOFTWARE.

Use of this software indicates acceptance of the terms and conditions of the Software License Agreement.

SurvCE End-User License Agreement

IMPORTANT-READ CAREFULLY: This Carlson Software End-User License Agreement ("EULA") is a legal agreement between you (either an individual or a single entity) and Carlson Software, Inc for the Carlson SOFTWARE accompanying this EULA, which includes computer software and may include associated media, printed materials, and "online" or electronic documentation ("SOFTWARE PRODUCT" or "SOFTWARE"). By exercising your rights to use the SOFTWARE, you agree to be bound by the terms of this EULA. If you do not agree to the terms and conditions of this EULA, you may not use the SOFTWARE. IF YOU DO NOT AGREE TO THE TERMS AND CONDITIONS OF THIS EULA, DO NOT CLICK THE "ACCEPT" BUTTON, AND DO NOT INSTALL OR USE ANY PART OF THE SOFTWARE.

Carlson Software, Inc., referred to as "LICENSOR", develops and/or licenses proprietary computer programs and sells use licenses for such proprietary computer programs together with or apart from accompanying copyrighted material and documentation and;

End User desires to obtain the benefits thereof and, in return for which, is willing to abide by the obligations and fee agreements applicable to LICENSOR's use licenses in LICENSOR's proprietary computer programs.

For good and valuable consideration, including but not limited to license grant in accordance with this Agreement by LICENSOR to End User's covenant regarding LICENSOR's proprietary rights, LICENSOR agrees to permit End User to utilize materials representing LICENSOR's product or products subject to the following terms and conditions:

1. License Grant: Subject to the terms, conditions and limitations of this EULA, LICENSOR hereby grants End User a personal, limited, non-exclusive, non-transferable, license to utilize the Software Product you have purchased. The license granted in this EULA creates no license, express or implied, to any other intellectual property of Licensor, except for the specific Software Product which they have lawfully purchased from LICENSOR. This EULA grants you the following rights: You may install and use one copy of the SOFTWARE PRODUCT, or any prior version for the same operating system, on a single computer. The primary user of the computer on which the SOFTWARE PRODUCT is installed may make a second copy for his or her exclusive use on a portable computer. Storage/Network Use. You may also store or install a copy of the SOFTWARE PRODUCT on a storage device, such as a network server, used only to install or run the SOFTWARE PRODUCT on your other computers over an internal network; however, you

must acquire and dedicate a license for each separate computer on which the SOFTWARE PRODUCT is installed or run from the storage device. A license for the SOFTWARE PRODUCT may not be shared or used concurrently on different computers.

2. Exclusive Source. End User shall obtain all LICENSOR authorized product materials through LICENSOR or LICENSOR'S authorized representative and no other source. LICENSOR authorized product materials include, but are not limited to, manuals, license agreements and media upon which LICENSOR's proprietary computer programs are recorded. End User shall make no copies of any kind of any of the materials furnished by LICENSOR or LICENSOR's authorized representative, except as specifically authorized to do so in this EULA. End User is not entitled to make archival copies of those portions of LICENSOR's product(s) that are provided on a machine readable media.

3. Proprietary Rights of Licensor. End User agrees that LICENSOR retains exclusive ownership of the trademarks and service marks represented by its company name and logo and all of the documentation and computer recorded data related thereto. End User also agrees that all techniques, algorithms, and processes contained in LICENSOR's computer program products or any modification or extraction thereof constitute TRADE SECRETS OF LICENSOR and will be safeguarded by End User, but in no event shall End User exercise less than due diligence and care in accordance with the laws of the country of purchase and International Law, whichever operates to best protect the interests of LICENSOR. End User shall not copy, reproduce, re-manufacture or in any way duplicate all or any part of LICENSOR products WHETHER MODIFIED OR TRANSLATED INTO ANOTHER LANGUAGE OR NOT, or in any documentation, or in any other material provided by LICENSOR in association with LICENSOR's computer program products regardless of what manner of storage and retrieval the product exists, except as specified in this Agreement and in accordance with the terms and conditions of this Agreement which remain in force. End User agrees that in the event End User breaches this EULA, End User will be liable for damages as may be determined by a court of competent jurisdiction.

4. Restrictions. End User's rights and obligations under this EULA are nonexclusive and personal in nature, and the intellectual property Licensor grants to End User is subject to applicable law other than bankruptcy law. End User may not transfer or assign the SOFTWARE, rights under this EULA or accompanying user documentation, or any updates of the SOFTWARE which may be provided under this EULA, to a third party unless End User receives written consent from Licensor at least 30 days prior to the completion of transfer. Licensor reserves the right to deny transfer or assignment if, in its sole discretion, Licensor determines the transfer not to be a necessity. Whether or not a transfer or assignment is allowed shall be determined in Licensor's sole discretion after taking into consideration certain factors to find the existence of a necessity including, but not limited to, merger or acquisition of an entity, complete asset acquisition, change of control, severe economic hardship, severe loss of human resources or significant loss in business divisions, or winding down of entity affairs. If Carlson consents to a transfer, such transfer shall be allowed only as a one-time permanent transfer of this EULA and Software to another end user, provided the initial End User retains no copies or previous versions of the Software. The transfer must include all of the Software, including all component parts, any media and printed materials, any upgrades, this EULA, and any associated license key. The transfer may not be an indirect transfer, such as a consignment, rental or lease. No corresponding Maintenance Agreement rights shall transfer with the SOFTWARE transfer to the subsequent end user. Prior to the transfer, the subsequent end user receiving the Software from the initial End User must agree to all terms of this EULA, with the added condition that no further transfers to third parties are permitted for any reason whatsoever, and shall agree to the terms and conditions of a new Maintenance Agreement with Licensor.

You may not reverse engineer, decompile, or disassemble the SOFTWARE or alter the images utilized in the SOFTWARE and user documentation. The SOFTWARE PRODUCT is licensed as a single product. Its component parts may not be separated for use on more than one computer. You shall communicate to any individual user in your facility that they are bound by the restrictions of this license agreement may not copy or alter the SOFTWARE for use outside End User's facilities.

Upgrades. If you purchase an upgrade of a SOFTWARE PRODUCT and you use it on different machine from one where upgraded SOFTWARE PRODUCT was used, use of original SOFTWARE PRODUCT must be discontinued and confirmed within 30 days. If such use is not discontinued, it is a material breach of this EULA and LICENSOR shall be entitled to all remedies available to it under this EULA, and under the laws of Kentucky, USA.

5. Warranty. THE PRODUCT IS PROVIDED "AS IS" WITH ALL FAULTS. TO THE MAXIMUM EXTENT PERMITTED BY LAW, LICENSOR HEREBY DISCLAIMS ALL WARRANTIES, WHETHER EXPRESS OR IMPLIED, INCLUDING WITHOUT LIMITATION IMPLIED WARRANTIES OF MERCHANTABILITY, FITNESS FOR A PARTICULAR PURPOSE, AND WARRANTIES THAT THE PRODUCT IS FREE OF DEFECTS AND NON-INFRINGEMENT, WITH REGARD TO THE SOFTWARE, AND THE ACCOMPANYING WRITTEN MATERIALS. YOU BEAR ENTIRE RISK AS TO SELECTING THE PRODUCT FOR YOUR PURPOSES AND AS TO THE QUALITY AND PERFORMANCE OF THE PRODUCT. THIS LIMITATION WILL APPLY NOTWITHSTANDING THE FAILURE OF ESSENTIAL PURPOSE OF ANY REMEDY. In any event, LICENSOR will not honor any warranty shown to exist for which inaccurate or incorrect identifying data has been provided to LICENSOR. The product(s) provided are intended for commercial use only and should not be utilized as the sole data source in clinical decisions as to levels of care.

6. LIMITATION OF LIABILITY. EXCEPT AS REQUIRED BY LAW, LICENSOR AND ITS DISTRIBUTORS, DIRECTORS, LICENSORS, CONTRIBUTORS AND AGENTS (COLLECTIVELY, THE "LICENSOR GROUP") WILL NOT BE LIABLE FOR ANY INDIRECT, SPECIAL, INCIDENTAL, CONSEQUENTIAL OR EXEMPLARY DAMAGES ARISING OUT OF OR IN ANY WAY RELATING TO THIS EULA OR THE USE OF OR INABILITY TO USE THE PRODUCT, INCLUDING WITHOUT LIMITATION DAMAGES FOR LOSS OF GOODWILL, WORK STOPPAGE, LOST PROFITS, LOSS OF DATA, AND COMPUTER FAILURE OR MALFUNCTION, EVEN IF ADVISED OF THE POSSIBILITY OF SUCH DAMAGES AND REGARDLESS OF THE THEORY (CONTRACT, TORT OR OTHERWISE) UPON WHICH SUCH CLAIM IS BASED. THE LICENSOR GROUP'S COLLECTIVE LIABILITY UNDER THIS AGREEMENT WILL NOT EXCEED THE GREATER OF \$500 (FIVE HUNDRED DOLLARS) AND THE FEES PAID BY YOU UNDER THIS LICENSE (IF ANY).

7. Update Policy. LICENSOR may, from time to time, revise the performance of its product(s) and in doing so, incur NO obligation to furnish such revisions to any End User nor shall it warrant or guarantee that any revision to the SOFTWARE will perform as expected by the End User on End User's equipment. At LICENSOR's option, LICENSOR may provide such revisions to the End User.

8. Customer Service. Although it is the LICENSOR's customary practice to provide reasonable assistance and support in the use of its products to its customers, LICENSOR shall not be obligated to any End User to provide technical assistance or support through this Agreement and may at LICENSOR's sole election charge a fee for customer support.

9. Termination of End User License. If any one or more of the provisions of this Agreement is breached, the license granted by this Agreement is hereby terminated. In the event of such termination, all rights of the LICENSOR shall remain in force and effect. Any protected health information data of End User maintained on LICENSOR'S data base shall upon reasonable notice to End User and at the discretion of LICENSOR may be destroyed.

10. Copyright. The SOFTWARE (including, but not limited to, any images, photographs, animations, video, audio, music and or text incorporated into the SOFTWARE), and all intellectual property rights associated with it, whether exists in a tangible media or in an electronic image media is owned by LICENSOR and is protected by United States copyright laws and international treaty provisions and all other commonwealth or national laws. LICENSOR reserves all intellectual property rights in the Products, except for the rights expressly granted in this Agreement. You may not remove or alter any trademark, logo, copyright or other proprietary notice in or on the Product. This license does not grant you any right to use the trademarks, service marks or logos of LICENSOR or its licensors. You may not copy any user documentation accompanying the SOFTWARE.

11. Injunctive Relief. It is understood and agreed that, notwithstanding any other provision of this Agreement, LICENSOR has the unequivocal right to obtain timely injunctive relief to protect the proprietary rights of LICENSOR.

12. Entire Agreement. This Agreement constitutes the entire agreement between the parties and supersedes any prior agreements. This Agreement may only be changed by mutual written consent.

13. End User Agreement Acknowledgment. The End User hereby accepts all the terms and conditions of this Agreement without exception, deletion, alteration. End User acknowledges they are authorized to enter this agreement on behalf of any organization for which the license is sought. Any unauthorized use of LICENSOR products will be considered a breach of this Agreement, subject to liquidated damages and otherwise unlawful and willful infringement of LICENSOR's trade secrets and/or proprietary products.

14. Payment and Refund Policy. The use of the SOFTWARE herein is deemed a commercial use and under the terms of this license agreement End User shall not be entitled to any refund of purchase price. End User agrees to pay all user fees promptly. LICENSOR is authorized by End User to suspend any further access to SOFTWARE in the event fees are not fully paid. End user entity shall promptly pay any and all access and use charges incurred regardless of the end user. End user is responsible for protecting any pass word and user identity supplied to End User.

15. Loss/Theft/Misuse. End user shall promptly report to LICENSOR the theft or other loss of any password and/or user identity required to access SOFTWARE. LICENSOR shall not be responsible for maintaining the integrity of End User data in the event that end user's data base is accessed and/or altered by an unauthorized end user due to the failure of licensed End User to protect its password or user identity. End User shall be responsible for any costs incurred by LICENSOR due to the negligence or reckless disregard of End User's failure to protect its password or user identity.

16. Civil/Criminal Investigation. End user shall fully cooperate with LICENSOR and or any person authorized by LICENSOR (including local, state, or federal law enforcement officials) to investigate any alleged theft, misuse or unauthorized use of SOFTWARE or data related thereto.

17. U.S. Government Restricted Rights. The SOFTWARE and documentation are provided with RESTRICTED RIGHTS. Use, duplication, or disclosure by the Government is subject to restrictions as set forth in subparagraph (c)(1)(ii) of the Rights in Technical Data and Computer Software clause at DFARS 252.227-7013 or subparagraphs (c)(1) and (2) of the Commercial Computer Software-Restricted Rights at 48 CFR 52.227-19, as applicable.

18. Governing Law. This EULA shall be governed and construed in accordance with the laws of the Commonwealth of Kentucky, USA.

Installation

This chapter describes the system requirements and installation instructions for Carlson SurvCE.

Using the Manual

This manual is designed as a reference guide. It contains a complete description of all commands in the Carlson SurvCE product.

The chapters are organized by program menus, and they are arranged in the order that the menus typically appear in Carlson SurvCE. Some commands are only applicable to either GPS or total station use and may not appear in your menu.

Look for the icons for either GPS mode and/or total station mode, found at the start of certain chapters. These icons will be located at the top (header) of these pages, or at the start of a chapter.



= Available in GPS Mode



= Available in Total Station Mode

For some commands both icons will be shown, indicating that the SurvCE command can be used in both GPS and total station modes.

System Requirements

The information below describes the system requirements and installation instructions for Carlson SurvCE.

Software

- Windows CE® or Windows Mobile version 4.0 or later. Handheld PC.
- Microsoft ActiveSync 3.7 and later.

RAM and Hard Disk Space Requirements

- 64 MB of RAM (recommended)
- 16 MB of hard disk space (minimum)

Hardware (Required)

- StrongARM, XScale or compatible processor (hardware must be supported by the Microsoft operating system being used)

Hardware (Optional)

- Serial cable for uploading and downloading data.

Microsoft ActiveSync

If you use Windows XP or an earlier version of the Windows Operating System on your computer, Microsoft® ActiveSync® provides support for synchronizing data between a Windows-based desktop computer and Microsoft® Windows® CE or Windows® Mobile based portable devices.

ActiveSync is only compatible with Windows XP or earlier. If you are running Windows Vista or Windows 7, you will need to download and install Windows Mobile Device Center from Microsoft.

You should have a USB cable or 9-pin null modem cable that was included with your mobile device. Attach this cable from your desktop PC to the mobile device. Before you can install Carlson SurvCE, your desktop PC must have Microsoft ActiveSync or Windows Mobile Device Center installed and running depending on what version of Windows is running on your computer. If you have ActiveSync on your desktop PC, you should see the ActiveSync icon in your system tray. If you do not see this icon in the tray, choose the Windows Start button, choose Programs and then choose Microsoft ActiveSync. If you do not have ActiveSync installed, insert the Carlson SurvCE CD-ROM and choose “Install ActiveSync”. You may also choose to download the latest version from Microsoft. After the ActiveSync installation starts, follow the prompts. If you need more assistance to install ActiveSync, visit Microsoft’s web site for the latest install details.

Auto Connection

If the default settings are correct, ActiveSync should automatically connect to the mobile device. When you see a dialog on the mobile device that asks you if you want to connect, press Yes.

Manual Connection

If nothing happens when you connect the cable, check to see if you have the ActiveSync icon in your system tray. If you see this icon, right click on it and choose “Connection Settings”. You should see the following dialog:

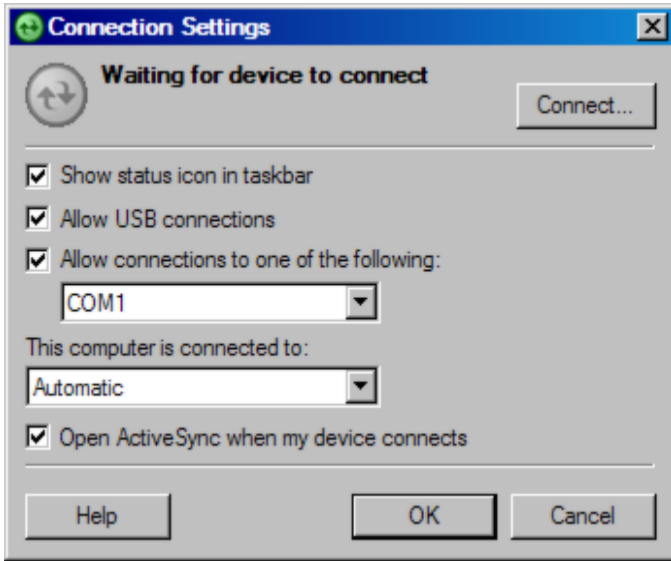

Be sure that you have selected the appropriate COM port or USB options. Assuming that you are using a COM port connection, you will choose the COM port (usually this will be COM1). Click Connect at the top right. You will now see the Get Connected dialog.

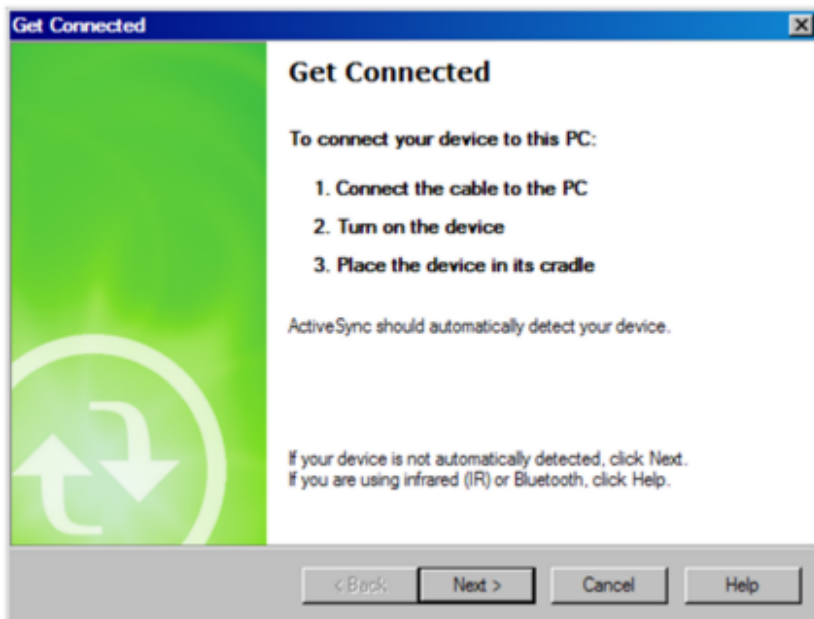

You now need to manually "link" to the remote device. Focus on the mobile device while still observing your PC screen. Observe the above dialog and, with your device properly connected to the PC, be prepared to click the Next button at

the bottom. Now look at the mobile device screen for the "PC Link" icon.

First, click Next on the PC. Then immediately double-tap the PC Link icon. (You may have to do the double-tap more than once.) If successful, after you press Next, the following screen will appear and the connection will be made.

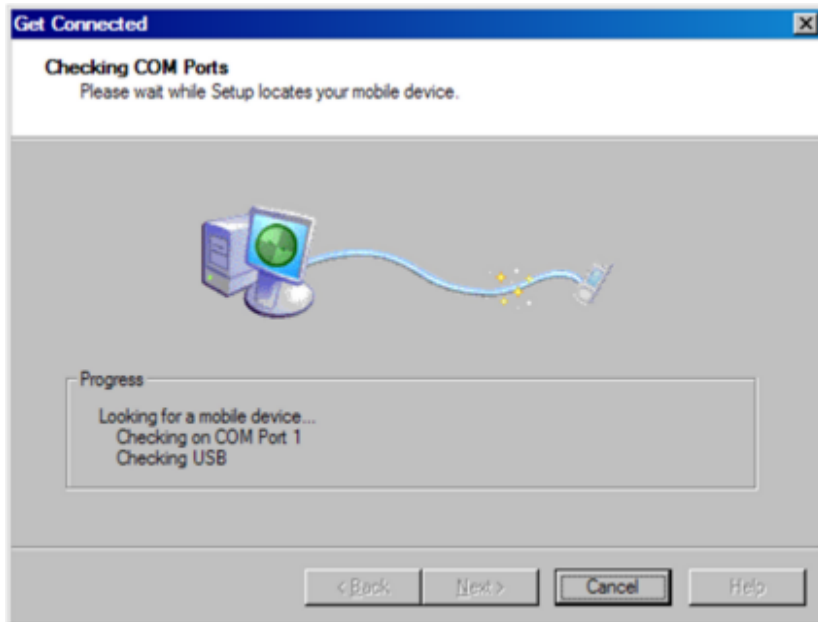

In ActiveSync, you will then see the New Partnership dialog. Click No to setting up a partnership, and click Next. When you see the icon in the system tray, and it is green with no "x" through it, you are connected. Once you are connected, you should see the following dialog. It should say "Connected":

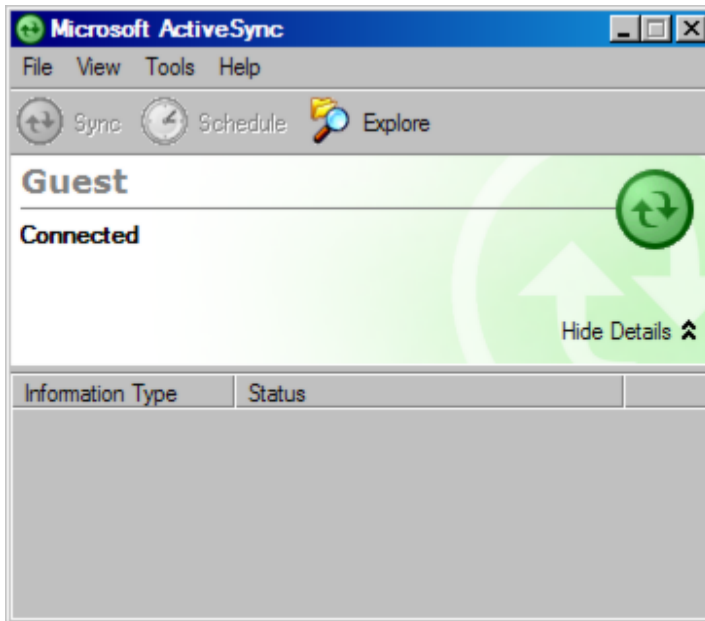

Troubleshooting

If you cannot get connected, make sure that no other program is using the COM port. Programs to check for include any Fax/Modem software and other data transfer software. If you see anything you think may be using the COM port, shut it down and retry the connection with ActiveSync.

Enabling COM Port Communication for ActiveSync on Allegro, Panasonic Toughbook 01 and other CE devices

In order for ActiveSync to communicate, it may be necessary to direct the CE device to utilize the COM port as a default. Some may come set default to USB. Go to Start (on Allegro, blue key and Start button), then Settings, and open the Control Panel. Next choose the Communications icon, then PC Connection. Choose COM1 at a high baud rate, such as 57,600 baud. This will download programs and files at a high rate of speed. On the Allegro, use PC Link to connect to PC with ActiveSync. On the Panasonic Toughbook, do Start, Run, and in the Open window, type in "autosync-go" (autosync then spacebar then "minus" go). Then go to Start, then Settings, and open the Control Panel. Choose the Communications icon, then PC Connection. Change Connection to Serial Port @ 115K. Make sure "Enable direct connections to the desktop computer" is checked.

Note: When using SurvCE's Data Transfer option, you will need to disable Serial Port Connection (uncheck Allow Serial Cable). This is done in the Connection Settings in ActiveSync. This option must be enabled again in order to use ActiveSync.

Installing SurvCE

Before you install Carlson SurvCE, close all running applications on the mobile device.

1. Connect the mobile device to the desktop PC and ensure that the ActiveSync connection is made.

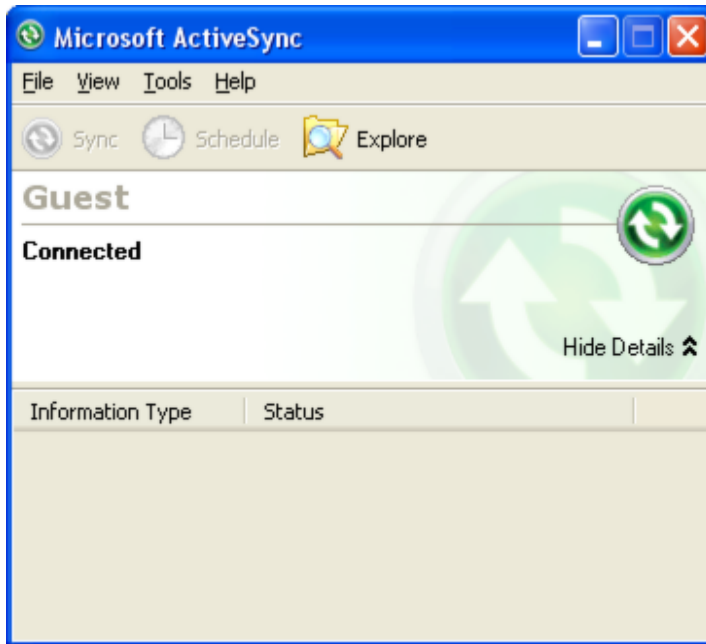

2. Insert the CD into the CD-ROM drive on the desktop PC. If Autorun is enabled, the startup program begins. The startup program lets you choose the version of SurvCE to install. To start the installation process without using Autorun, choose Run from the Windows Start Menu. Enter the CD-ROM drive letter, and setup. For example, enter d:\setup (where d is your CD-ROM drive letter).
3. On the desktop PC, a Welcome dialog will appear. Click Next.



4. On the next dialog, you must read and accept the Carlson SurvCE End-User License Agreement (EULA). If you agree with the EULA, click "I accept ..." and then select Install. If you do not agree with the EULA, click "I do not accept ..." and the installation program will quit.

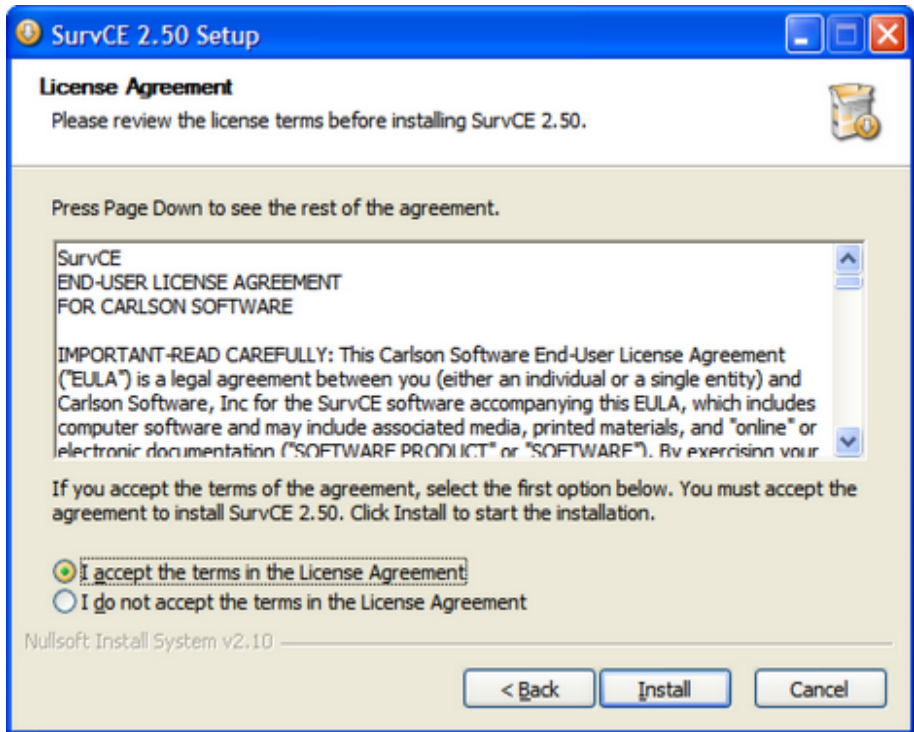

5. The next dialog asks you to confirm the installation directory. Press Yes.

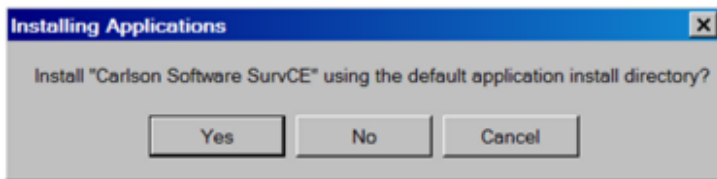

6. At this point, the necessary files will be copied to the mobile device. A dialog will appear to show installation progress.

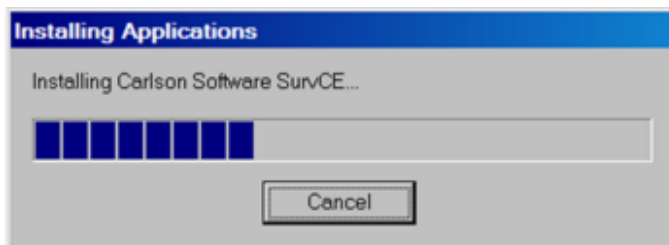

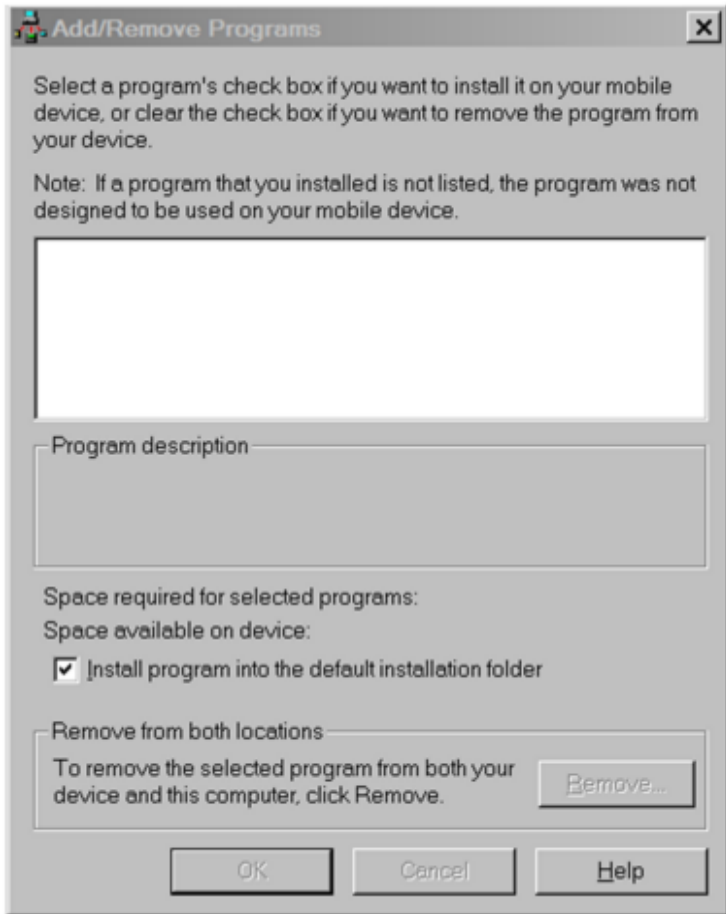

7. You are given a final chance to check your mobile device. Click OK when you are ready, then click Finish on the desktop PC.

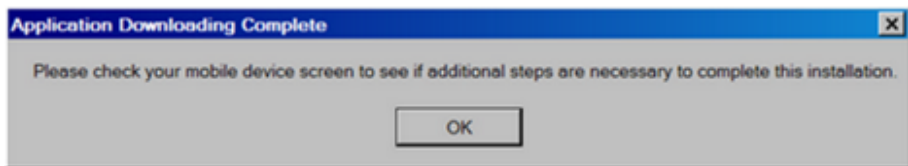

8. On the Data Collector - Tap "Install" in the bottom left to install SurvCE to the default location of "Device". After tapping Install you will see an hourglass with a progress bar showing the installation progress.

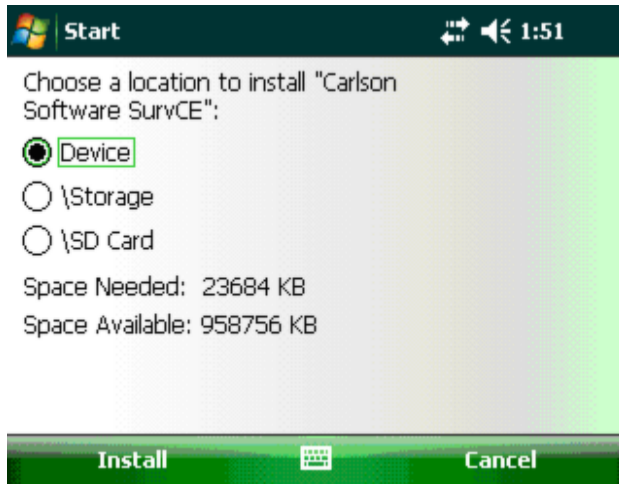

9. Once the Status Bar finishes on the data collector it will say“Carlson Software was successfully installed’. Tap OK in the upper right to complete the installation of SurvCE.

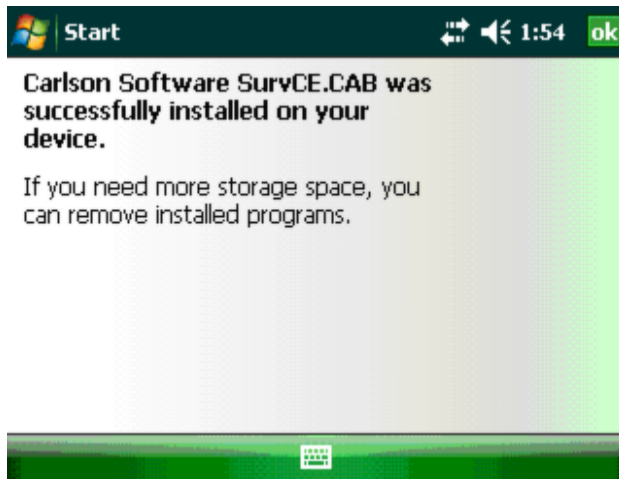

Authorizing SurvCE

The first time you start SurvCE, you are prompted to register your license of the software. If you do not register, SurvCE will remain in demo mode, limiting each job file to a maximum of 15 points.

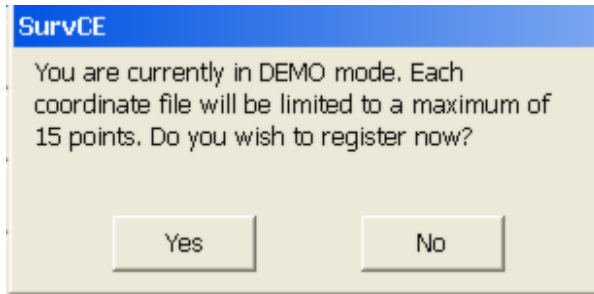

1) If you open SurvCE and it says you are in “Demo Mode”, tap Yes to register now. If you are at the Main menu of SurvCE already you can tap the Equip tab / About SurvCE and tap Change Registration to access this screen.

2) Type in your SurvCE Serial number into the Serial Number box at the top

3) Tap the “Get Code” button

4) Now go to the SurvCE website at www.survce.com to complete your registration via the Internet

PLEASE NOTE: If you do not have access to the Internet, you may fax your company name, phone number, email address, your SurvCE serial number, Hardware #1, Hardware #2 and the registration code to 606-564-9525. Your registration information will be faxed back to you within 48 hours.



5) Click on the “Registration Page” icon under Version 2.0/2.5

6) Fill out this form with your Name and Company information / type in your SurvCE 2.0/2.5 Serial number in the “Serial Number” box and make sure to include the Dashes

7) Fill in the Hardware #1 and Hardware #2 boxes with the Values displayed on your Data Collector Screen {If you have trouble finding them click the “where is it located link”}

8) Choose the Reason for Install of “Initial Installataion” if this is your First time registering SurvCE

9) Fill in the Registration Code from the screen of your Data Collector and make sure to include the Dash

10) Click the Submit Registration Button

11) If this is your first time Registering SurvCE 2.0/2.5 you may need to fill in Some Contact Details then click “Submit Contact Information”

12) If this is your first time Registering this Data Collector with SurvCE 2.0/2.5 please Select the “Device Model” from the List and fill in the “Device Serial Number” and click the “Register Device to Complete Registration” button

13) Your Change Key will be displayed in a BOX in the Top Left of the SurvCE 2.0/2.5 Registration summary. Type this change key in on the “Change Key” box on your Data Collector then tap OK

14) You should receive a message saying “Successful SurvCE 2 Registration!”. Tap OK

15) Your Carlson SurvCE Software is now Fully Registered. Your change key will also be emailed to the address that you submit. Keep a copy of this email for your permanent records.

Hardware Notes

If SurvCE quits responding, you can reset the hardware by following the applicable procedures described in the hardware documentation. For the Carlson Mini, Surveyor and Surveyor+, if the data collector locks up, or is unresponsive, a hard reset can be performed by holding down the on/off button for two seconds. A menu will appear on the screen. Choose "Reset" to reset the data collector. If the menu does not appear, or the data collector does not respond to screen taps, continue holding down the power button. After about 7 seconds, the amber light will turn on, and the data collector will reset automatically.

A full list of data collector hardware compatible with SurvCE 3.0 is found at <http://www.carlsonsw.com/products/data-collection/survce/#hardware>.

Color Screens

SurvCE 1.21 or greater enables viewing of color. Any red, green, blue or other

colored entities in DXF files will retain their color when viewed within SurvCE. Points will appear with black point numbers, green descriptions and blue elevations. Dialogs and prompting will utilize color throughout SurvCE.

Memory

Memory is NOT an issue with newer data collectors running Windows Mobile such as the Carlson Mini, Surveyor and Surveyor+. Please ignore this section of you have a Windows Mobile device. For all Windows Mobile users, there is no need to do any memory allocation. This section applies only to older, Windows CE devices like the early Rangers and Allegros.

Memory on most Windows CE devices (excluding Windows Mobile), can be allocated directly by the user for best results when running or installing SurvCE. We recommend setting "Storage Memory" to a minimum of 16,000 KB. The following discussion is an example for setting that memory. An equivalent process should be used for other CE devices, as available.

The SurvCE controller will function better during topo and stakeout with the "Storage Memory" set to around 18,000 KB. Use the following process to check and/or change the settings:

Go to the start menu by simultaneously hitting the **Blue Key** and **Start**. Choose **Settings**, then **Control Panel**, then double click on **System**. Touch the **Memory tab** and slide the pointer toward the left, which is the Storage Memory side, so that **Allocated** is around **18,000 KB**.

Keep in mind that to upgrade software, this setting may need to be changed back, so that the Program Memory has more available. To change, do as above but slide the pointer toward the right, which is the Program side, so that **Allocated** is around **18,000 KB**. This assures that there is enough Program memory, so that the new updates can be saved.

Once the upgrade or additional software is added, you can change it back so that the pointer is more toward the Storage Memory -- around 18,000 KB.

After changing these settings, or updating software, it's a good idea to do a "Save System".

Battery Status

Battery Status of Data Collector: The black icon that appears at the top of every screen is designed to indicate battery status of the data collector itself. Full black should indicate full battery. As battery levels decrease the black recedes to full white (out of battery).



Most Windows Mobile devices show an accurate battery status. If you tap the

battery icon, it will display the exact battery percent available, as in 73% (for example). On some CE devices, there is no way to detect battery status, so the battery icon does not change. On other devices such as the Jett CE, a partial indication of battery status is detected as follows:

- Good - 100%
- Low - 50%
- Critical – 10%

Battery Status of Instrument (some models): For many instruments including Sokkia and Topcon, you can select the "i" (for information) button within Instrument Setup (Current tab) and see details on the instrument including battery status. This is also useful for verifying the firmware version of the instrument. Battery status is also reported for many GPS systems such as Altus APS-3, where both the A and B battery status is displayed. For the Carlson Surveyor+ GPS system, clicking "i" for information will also show the A and B battery status.



Save System

On older Windows CE devices, it's highly recommended that you perform a Save System on the device after installing SurvCE or making any system level changes (eg. memory settings).

Examples:

Carlson Explorer

Start Programs SaveReg

Allegro

Start Programs Utilities Save System

This is not necessary (or even possible) on most Windows Mobile data controllers, like the Carlson Mini, Surveyor and Surveyor+. Windows Mobile itself protects against loss of registries and data when the power is low or disrupted.

Carlson Technical Support

Contact information for tech support for SurvCE is provided below:

Carlson Software, Inc.

Corporate Headquarters

Maysville, KY, USA

Tel (606) 564-5028

Fax (606) 564-6422

e-mail: support@carlsonsw.com

Carlson EMEA, BV

Corporate Headquarters

Almere, Netherlands

Tel: +31 36 750 1781

www.carlsonemea.com

e-mail: support@carlsonsw.com

Customer Service, Technical Support, Repair:

If you need assistance with your Carlson Software products, please call by telephone, or send an e-mail to the address above. U.S. support hours are Monday through Friday, 8:00 A.M. to 6:00 P.M. (EST, GMT -5 hours). EMEA support hours are Monday through Friday, 8:00 A.M. to 6:00 P.M. (GMT +1).

User Interface

This chapter describes the general user interface features of SurvCE.

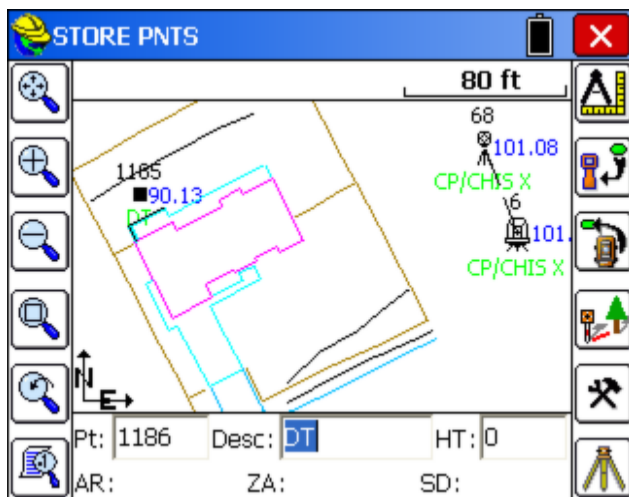
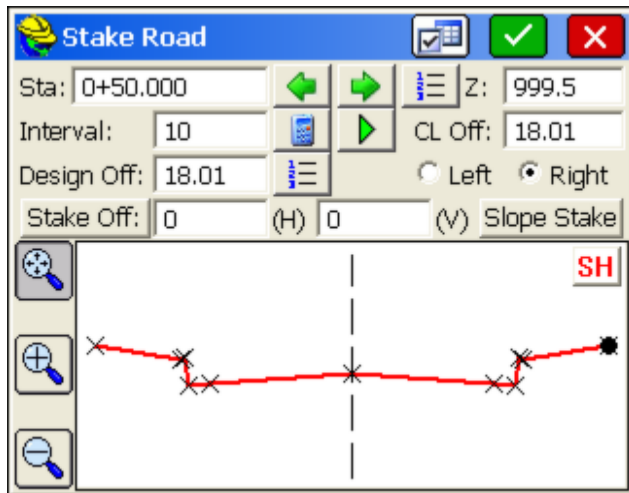























Graphic Mode











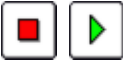

Icons

SurvCE 2.0 can be configured to show either the traditional letter icons or graphical icons for several functions. To set this option, go to the EQUIP tab, select Configure and toggle the "Use Graphic Icons" check box.

-   This icon will **R**ead a measurement (ALT-R).

-   Total Station Only. This icon will **T**raverse to the measured point by advancing your setup (ALT-T).
-   This icon will **S**tore a point. This function is also performed via the Enter key. (ALT-S).
-   This icon will lead to a dialog where the user can **A**verage up to 999 epochs of GPS readings (ALT-A).
-   This icon leads to **O**ffset reading screens with options for keyed-in offsets as well as offsets taken by laser and hydrographic devices that measure distance only, or distance and azimuth (ALT-O).
-   This icon will take you to the **C**onfigure dialog, also found on the EQUIP tab. Here you set many preferences in SurvCE such as the number of readings to average, function of the Store icon, and whether to display the Hgt/Desc prompt on Save (ALT-C).
-   This icon will advance stake location incrementally to the **N**ext point or station (ALT-N).
-   This icon returns to the previous stakeout settings dialog where you can **M**odify the current design stake data.
-   This icon allows the user to override the design **E**levation (ALT-E).
-  **OK:** This icon will accept the dialog.
-  **Back:** This icon will return you to the previous dialog.
-  **Exit:** This icon will return you to the main menu and dismiss any changes (ALT-X).
-  **Standby/Search:** Robotics only. This status icon shows the instrument is in standby and when pressed, puts the instrument in search mode when then leads to lock mode when the prism is found.
-  **Locked:** Robotics only. This icon shows that the instrument is locked on the prism, and when pressed, places the robotic total station in Standby mode, meaning it will suspend tracking mode (e.g. allows you to place the pole down, drive a stake, then resume work).
-  **Tracking is On:** Robotics only. This icon shows that the instrument is continuously measuring distances (tracking) and when pressed will stop the EDM.
-  **Tracking is Off:** Robotics only. This icon shows that the instrument is

NOT continuously measuring distances (not tracking) and when pressed will start the EDM.

-  **Prism Mode:** This icon shows that the instrument is currently configured to read a prism and when pressed will switch the instrument to reflectorless mode.
-  **Reflectorless Mode:** This icon shows that the instrument is currently in reflectorless mode and when pressed will switch the instrument to prism mode.
-  **Stop/Go:** This icon, inside of Auto By Interval, begins and pauses the action of recording points (ALT-G).
-  **Monitor/SkyPlot:** This icon will take you to the Monitor/SkyPlot screen for GPS status and Coordinate and Lat/Long display (ALT-D).
-  **Tripod:** This will take you to the Instrument Setup dialog. This dialog contains Backsight, Setup, Robotics and Remote Benchmark (ALT B).
-  **Zoom Extents:** This zooms the entire drawing to fit the screen.
-  **Zoom In:** Zooms in 25%.
-  **Zoom Out:** Zooms out 25%.
-  **Zoom Window:** Zooms into a rectangular area that you pick on the map screen.
-  **Zoom Previous:** Zooms to the previous view. SurvCE remembers up to 50 views.
-  **View Options:** Displays the View Options dialog box, where you can control aspects of points such as the symbol, the style of the plot and the freezing or thawing of attributes such as descriptions and elevations. To avoid “point clutter”, you can even set it to show only the last stored point along with setup and BS. See the *View Options* section of this manual.
-  **Settings:** This icon leads to settings associated with the current command or option.

Pan

You can also pan the screen simply by touching it, then holding and dragging your finger or stylus along the screen surface. Pan is automatic and needs no prior command.

View/Edit Points by Touch

You can edit or delete any point by simply clicking on it graphically. In the Store

Points command, clicking on a point also allows you to Re-Measure the point location, both in GPS and Total Station mode.

Text Mode

The Text screen uses a large character size for easy viewing, and limits options to Monitor/Skyplot, Offset and Store. Select the Text mode by clicking on the Helmet in the upper left of the screen, in most active survey commands, choosing Text. You can return to the Graph view by tapping the **Helmet** icon and choosing Graph. You can also temporarily view your points on the screen by tapping **Map**, then tap **Back** to return to the text-based data collection screen. Note that the program will remember which screen you were in last (Graph or Text) and return to that mode of data collection automatically.

View Options

The graphic view has all of the standard zoom icons as well as a View Setting Icon in the lower left. This icon allows you to change the way the graphical items will be displayed. The View Setting Icon will show more options such as the "Alt-F" (store last point only) option when clicked during commands such as Store Points and Stake Points (active survey commands).

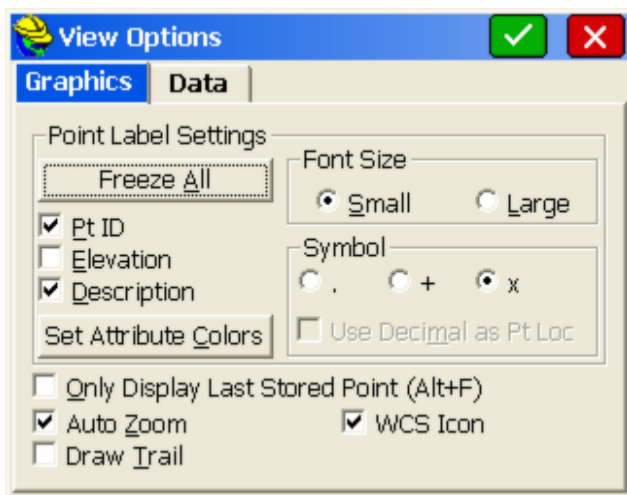

- **Freeze All:** This toggle will freeze (hide from view) the point attributes (e.g. Point ID, Elevation and Description). Each attribute can be toggled off separately as well.
- **Font Size:** Points can be small (default setting) or large and bold for easier readability.
- **Use Decimal as Point Location:** This toggle will adjust the text location so that the point location is the decimal point of the elevation. It applies if the "dot" symbol is used.
- **Set Attribute Colors:** This button will allow users to specify the colors of the point text (color units only).

- **Only Display Last Stored Point (ALT-F):** This toggle will result in SurvCE only displaying the linework collected, the instrument and backsight points, and the last point collected. This is a popular setting to reduce the clutter of numerous points displayed all at once.
- **Auto Zoom:** Normally clicked on, this setting zooms to your location in survey commands at the current zoom magnification, and in stakeout commands, the zoom includes your target and current location. If turned off, the program holds the current window.
- **Draw Trail:** For GPS and robotic total station work where the current position is updated continuously, the direction of movement is shown by an added trail or tail associated with the arrowhead (current position).
- **WCS Icon:** This shows the N/E icon on the graphic screen, for orientation.

The Data tab goes to a secondary screen which normally shows only the Intelligent Zoom option, but when selected from the Map screen (globe icon), also includes Traverse Defaults:

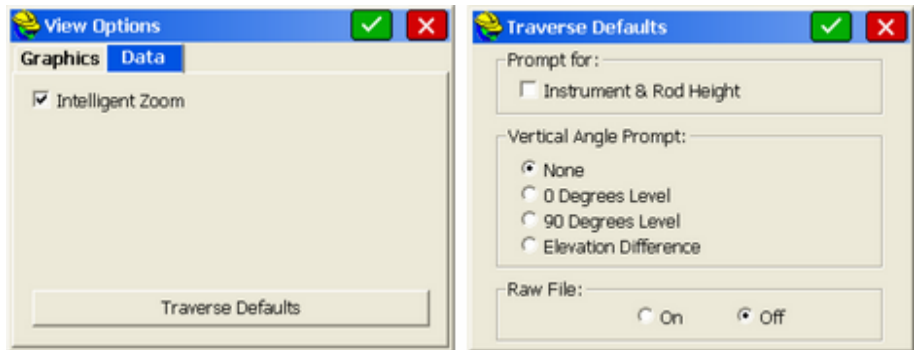

- **Intelligent Zoom:** When selecting points "From Map" in commands such as Inverse or Stake Points, the "Intelligent Zoom" allows you to pick the point from the screen in a condensed area of points, and the program will auto-zoom allowing you to pick again and obtain the precise point that you want. If Intelligent Zoom is off, you would instead see a list of points and must pick from the list or return to the Map screen and zoom in closer using the Zoom + or Zoom Window options.
- **Traverse Defaults:** The T for Traverse and S for Sideshot commands, within the Map screen, will prompt for instrument height, rod height and zenith angles as set in this dialog, and will optionally store to the raw file for processing. This allows for very fast manual entry of raw field data.

Quick Calculator

From virtually any dialog entry line in the program, the ? command will go to the Calculator routines and allow copying and pasting of any selected calculation result back into the dialog entry line.

For example, if you were grading a site that had 4 subgrades, and had modeled the top surface, you need to grade to the lowest subgrade surface with a vertical offset of $(0.12+0.15+0.33+0.25)$. You could quickly obtain the value by entering ? in the Vertical Offset field within the **Elevation Difference** dialog, as shown in this next figure.

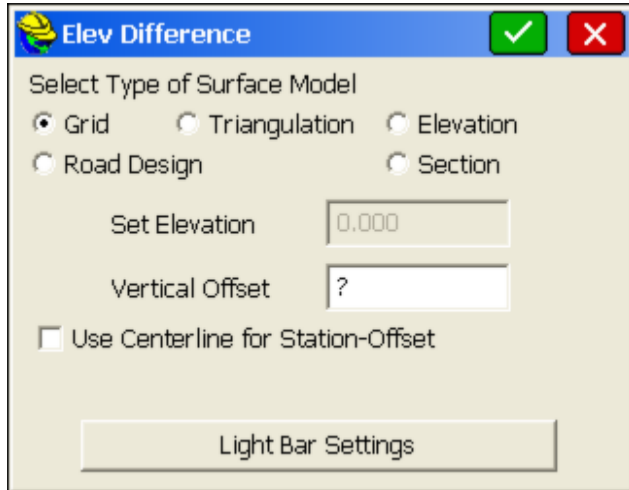

This leads immediately to the **Calculator** dialog, with its four tabs, or options, many with sub-options. Using the Standard tab, we can enter $0.12+0.15+0.33+0.25$ and then "=" . Then select the **Copy** button, which places the value in the banner line at the very top of the screen. Then choose **Paste** to paste the value back into the **Vertical Offset** dialog edit box. Change the sign to "-" for negative, as needed. Calculations can also be done directly from the edit box within the **Vertical Offset** dialog. You could enter "19.5 in" for inches, which would auto-convert to feet or the current units setting. In this same edit box, you could also enter $19.5/12$, which would do the division directly in the edit box.

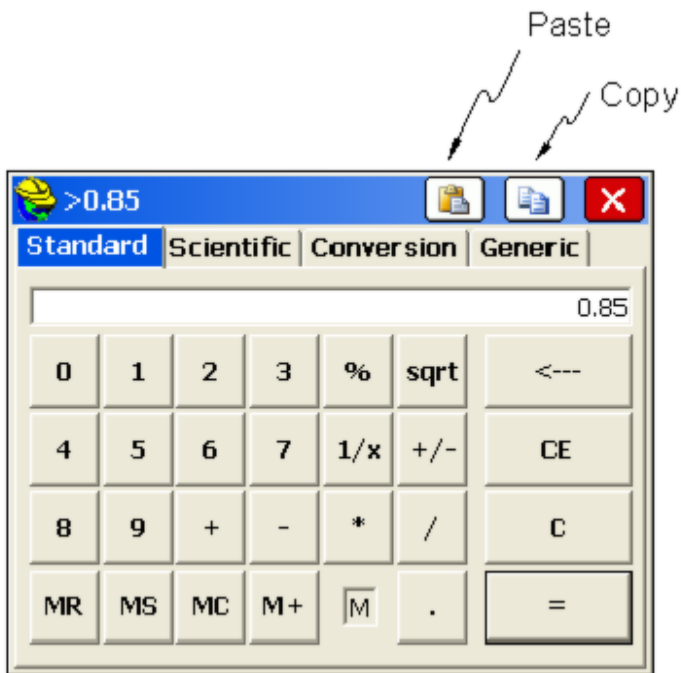

Hot Keys & Hot List

The ALT key commands take the form ALT-C (Configure Reading) or ALT-N (Next Point). The ALT key and the subsequent "Hot Key" ("C" or "N", as mentioned here) can be entered at nearly the same time or with any delay desired. If you press ALT and delay the entry of the hot key, you will see a text instruction: "Waiting for HotKey... Press Alt again to return". A second ALT returns to the previous position in the program without executing any command. ALT- < and ALT- > will brighten or darken screens on "At Work" brand CE data collectors.

List of Hot Key Commands Activated by ALT

Many of the hot keys work only within related data gathering commands, as opposed to working from the main menus. Hot Keys vary by command. For example, in the Store Points screen, the hot keys are as follows.

- ALT-R: Read (Total Station Only)
- ALT-S: Store (or Shot/Store)
- ALT-O: Offset
- ALT-C :Configure Reading
- ALT-B: Backsight (Total Station Only)

Here is a list of other common hot keys:

- **ALT-E:** Target Elevation — From the stakeout screen in any Stakeout Line/Arc command, Offset Stakeout, Elevation Difference and virtually all stakeout commands except Stakeout Points, ALT-E will allow the user to enter an alternate design elevation different from the computed current design elevation. The screen prompt appears below:

Override design elevation
 Design El: 509.1747
 Set El to: 519.35

- **ALT-F:** Foresight Only Toggle. When in the Store Points graphic screen and taking new shots, ALT-F will freeze all but the setup point number, backsight point number and current foresight shot. This is helpful when points are densely located. Alt F again returns to the full point plot. Linework remains. In GPS Mode, Alt-F hides (freezes) all points, but shows a solid square symbol for the last GPS-measured point.
- **ALT-H:** Help. Takes you to the Help menu, where available.
- **ALT-I:** Inverse. Does a quick inverse, and upon exit, returns you to the command you were in. Inverse is also accessible from the Helmet in the upper left of the screen, in many commands including Store Points.
- **ALT-J:** Joystick. Applies only to robotic total station. Takes you to the Settings option. ALT-J typically only functions if you are configured for a robotic total station. ALT-J will work from within data gathering commands, most stakeout commands (eg. Stake Points) and from the main menus.
- **ALT-L:** List, as in Feature Code List. When entered in any Description field, this will recall the Feature Code List, which displays the characteristics (layer/linework) of the feature code. This serves not only as a way to select the code and apply it to the description, but it also serves as a handy reminder of the code's properties. Helmet-Codes also goes to the Feature Code List.
- **ALT-M:** Map Screen. ALT-M will switch to the map screen.
- **ALT-N:** Next. Moves you to the Next point or station in the Stakeout commands.
- **ALT-T:** Traverse. Takes a reading and advances the setup to the measured point. The instrument setup dialog is presented for verification. Applies when in the Store Points routine.
- **ALT-V:** Shortcut to View the Raw Data, Point Data, Feature Codes and Cutsheets.
- **ALT-W:** Write a Note anytime with this command. Notes store to the Raw File.
- **ALT-X:** Shortcut to Exit most commands. Similar to Esc (escape key).
- **?:** The '?' character can be used in any field that requires a numerical entry to access the Calculator. (The Sokkia SDR8100 is an exception. This device uses the '=' symbol.)

In most measurement screens you can also select the SurvCE Helmet icon at the

top left to access the hot list of shortcuts to other routines. Depending on what commands you are in, or if a Bluetooth devices is involved (Reconnect option), the Helmet options appear as shown:

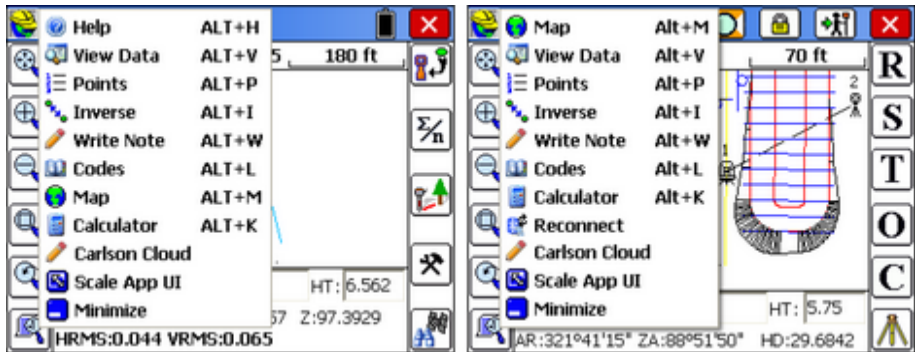

While in any Topo (Store Points) or Stakeout routine, a number of features are accessible by pressing ALT, followed by the corresponding Hot Key. Below is a list of Hot Keys arranged by routine and equipment type.

Action in Topo Mode Summary

Key	GPS	Conventional TS	Robotic TS
A	Take Average Reading	Read and Store (All)	Read and Store (All)
B		Total Station Setup	Setup and Robotics
C	Configure Reading	Configure Reading	Configure Reading, Sets, Settings and Search
D	Monitor GPS	Manual Read	Leica: Toggle EDM; Others: Manual Read
E			
F	Freeze Points	Freeze Points	Freeze Points
G	Start/Stop Interval Recording		Start/Stop Interval Recording
H	Help	Help	Help
I	Inverse	Inverse	Inverse
J		Sokkia Motorized: Joystick	Joystick
K	Calculator	Calculator	Calculator
L	Feature Code List	Feature Code List	Feature Code List
M	View Map	View Map	View Map
N			
O	Offset Point	Offset Point Collection	Offset Point Collection

	Collection		
P	List Points	List Points	List Points
Q	Toggle Prompt for Hgt/Desc	Toggle Prompt for Hgt/Desc On and Off	Toggle Prompt for Hgt/Desc On and Off
R		Read	Read and Store
S	Store	Store	Store
T		Traverse	Traverse
U			
V	View Raw File	View Raw File	View Raw File
W	Write Job Notes	Write Job Notes	Write Job Notes
X	Exit to Main Menu	Exit to Main Menu	Exit to Main Menu
Y	Toggle Graphics/Text Mode	Toggle Graphics/Text Mode (Helmet-Graph to return)	Toggle Graphics/Text Mode (Helmet-Graph to return)
Z	Zoom to Point	Zoom to Point	Zoom to Point

Action in Stakeout Mode Summary

Key	GPS	Conventional TS	Robotic TS
A			
B		Total Station Setup	Total Station Setup
C	Configure Reading	Configure Reading	Configure Reading
D	Monitor GPS		Leica: Toggle EDM
E	Set Target Elevation	Set Target Elevation	Set Target Elevation
F	Freeze Points	Freeze Points	Freeze Points
G			
H	Help	Help	Help
I	Inverse	Inverse	Inverse
J		Sokkia Motorized: Joystick	Joystick
K	Calculator	Calculator	Calculator
L	Feature Code List	Feature Code List	Feature Code List
M	View Map	View Map	View Map
N	Next Point/Station to Stake	Next Point/Station to Stake	Next Point/Station to Stake
O			

P	List Points	List Points	List Points
Q			
R		Read	Read and Store
S	Store	Store	Store
T			
U			
V	View Raw File	View Raw File	View Raw File
W	Write Job Notes	Write Job Notes	Write Job Notes
X	Exit to Main Menu	Exit to Main Menu	Exit to Main Menu
Y	Toggle Graphics/Text Mode	Toggle Graphics/Text Mode (Helmet-Graph to return)	Toggle Graphics/Text Mode (Helmet-Graph to return)
Z	Zoom to Point	Zoom to Point	Zoom to Point

Carlson Cloud

Features of Carlson Cloud

The Cloud feature is accessible in the Helmet of SurvCE and SurvPC. It offers the following capabilities.

- **Messaging from Office to Field Staff and Peer-to-Peer**
- **File Transfer from Office to Field Staff and Peer-to-Peer**
- **"Crew View"—viewing of Rover Positions in particular when using GNSS equipment on Grid Coordinates**
- **For SurvPC only, Data Storage into the Same Job File (CRD File) by multiple Survey Crews**

Setting up a Company Account

For each company, an account can be established using the option New User. The first user in a company needs to establish the company key word, ideally something unique so there is little or no potential for other companies to log into the same name. Each user within the company should have their own name and password, as shown below:

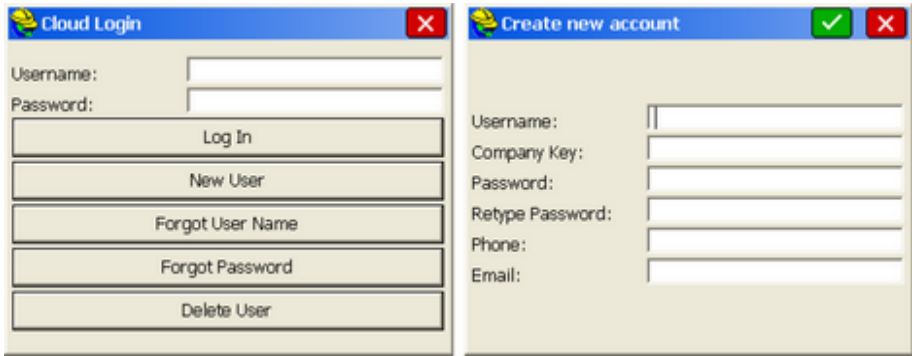

If you create a new account within the same company and don't match the name, you will get this screen:

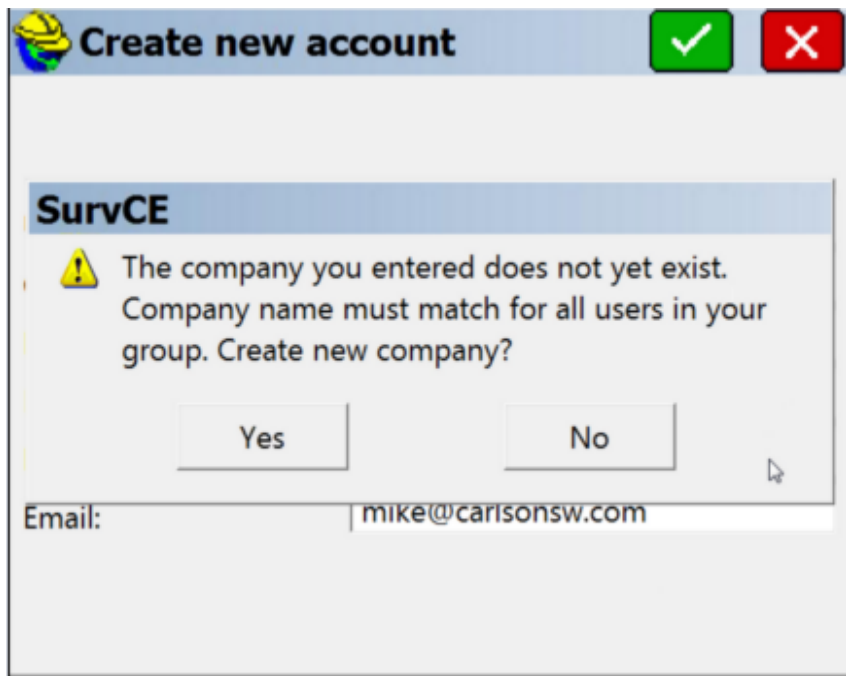

Once successfully logged in, you can select any other company member to message, and you can exchange files. Click the paper clip to attach a file and then tap Send. The recipient will obtain a notice and can download or discard the file.

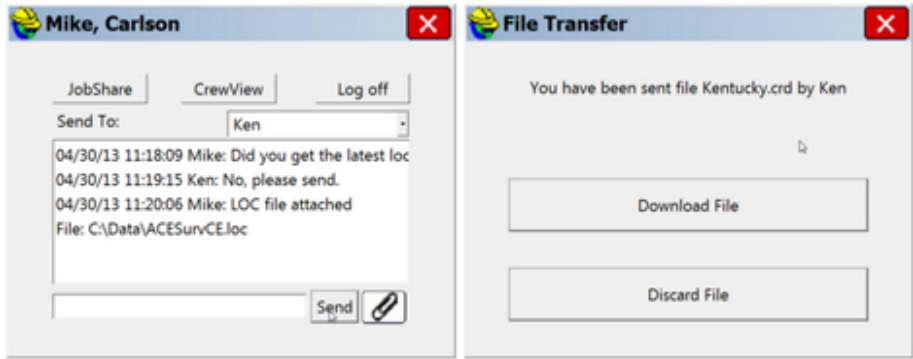

Tapping Crew View can lead to viewing of other crew members as shown below. They appear as Point ID's which you can calculate distance to (Inverse command) or navigate to, if needed. The positions of crew members update about once every 5 minutes.

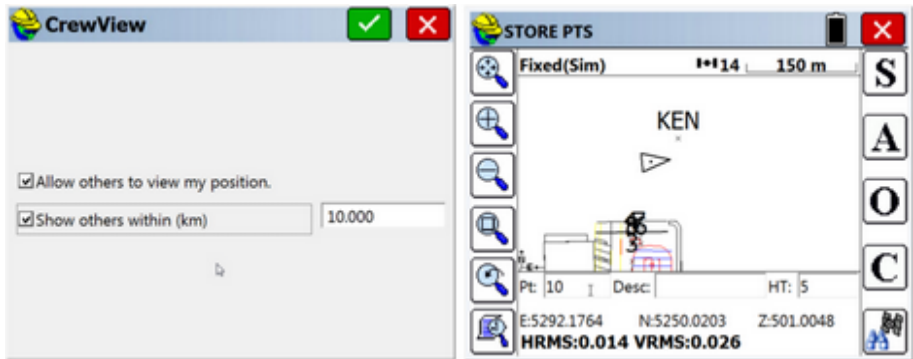

Instrument Selection

The user can switch between current instruments using the Instrument Selection flyout on the top bar of the SurvCE.

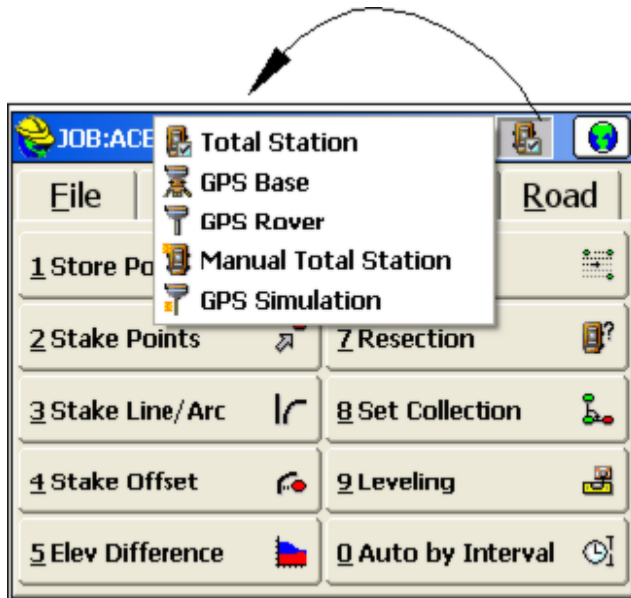

Input Box Controls

When point IDs are used to determine a value, the program will search for the point IDs in the current job. If not found it will then search in the control job, if active.

Formatted Distance/Height Entries

Entries for distances or heights that include certain special or commonly understood measurement extensions are automatically interpreted as a unit of measurement and converted to the working units as chosen in job setup. For example, a target height entry of 2m is converted to 6.5617 feet if units are configured for feet. The extension can appear after the number, separated by a space (2 m), or can be directly appended to the number (2m). For feet and inch conversion, the second decimal point informs the software that the user is entering fractions (See Below). Recognized text and their corresponding units are shown below:

- **f or ft:** US Feet
- **i or ift:** International Feet
- **in:** Inches
- **cm:** Centimeters
- **m:** Meters
- **###.##:** Feet and Inches (e.g. 1.5.3.8 = 1'5 3/8" either entry format is supported)

These extensions are automatically recognized for target heights and instrument heights, and within certain distance entry dialogs. Entries are not case sensitive.

Formatted Bearing/Azimuth Entries

Most directional commands within SurvCE allow for the entry of both azimuths and bearings. Azimuth entries are in the form 350.2531 (DDD.MMSS), representing 350 degrees, 25 minutes and 31 seconds. But that same direction could be entered as N9.3429W or alternately as NW9.3429. SurvCE will accept both formats. Additional directional entry options, which might apply to commands such as Intersection under Cogo, are outlined below:

If options in Job Settings are set to Bearing and Degrees (360 circle), the user can enter the quadrant number before the angle value.

Example

120.1234

The result is N20°12'34"E.

Quadrants

- | | |
|---|----|
| 1 | NE |
| 2 | SE |
| 3 | SW |
| 4 | NW |

In the case where Job Settings have been set for Bearing, and the user would like to enter an Azimuth, the letter A can be placed before the azimuth value and the program will convert it to a Bearing.

Example

A20.1234

The result is N20°12'34"E.

In the case where Job Settings is set to Azimuth and the user would like to enter a bearing, the quadrant letters can be used before the bearing value.

Example

NW45.0000

The result is 315°00'00".

Formatted Angle Entries

Interior Angle: The user can compute an angle defined by three points by entering the point IDs as <Point ID>,<Point ID>,Point ID>. The program will return the interior angle created by the three points using the AT-FROM-TO logic. Such entries might apply to the Angle Right input box in Store Points when configured to Manual Total Station.

Example

1,2,3

Using the coordinates below, the result is 90°00'00". Point 2 would be the vertex point.

Pt.	North	East
1	5500	5000
2	5000	5000
3	5000	5500

Mathematical Expressions

Mathematical expressions can be used in nearly all angle and distance edit boxes. For example, within the Intersection routine, an azimuth can be entered in the form 255.35-90, which means 255 degrees, 35 minutes minus 90 degrees. Additionally, point-defined distances and directions can be entered with a comma as separator, as in 4,5. If point 4 to point 5 has an azimuth of 255 degrees, 35 minutes, then the same expression above could be entered as 4,5-90. For math, the program handles “/”, “*”, “-“ and “+”. To go half the distance from 103 to 10, enter 103,10/2.

Point Ranges

When ranges of points are involved, such as in stakeout lists, a dash is used. You can enter ranges in reverse (e.g.. 75-50), which would create a list of points from 75 down to 50 in reverse order. For example, in Stake Points, you could enter 75-50 for the point to stake, click "Add to List", then starting at point 75, stake 74, then 73, etc. by clicking N for Next.

Survey Data Display Controls

ANGLE

The angle control will display the angle as defined by the current settings in Job Settings.

Options are available for Azimuth (North or South) or Bearing combined with the option of Degrees or Grads.

Format

The display format of degrees uses the degree, minute, and second symbols. For the case of a bearing we display the quadrant using the characters N, S, W, E.

Example Bearing

N7°09'59"E

Example Azimuth

7°09'59"

All angular values entered by the user should be in the DD.MMSS format.

Example

7.0959

The result is 7°09'59".

Formulas

Formulas can be entered for working with angles. The format must have the

operator after the angle value.

Example

90.0000 * 0.5

The result would be 45°00'00"

DISTANCE

The distance control will display the value using the current Job Settings unit. You can enter a formula using the mathematical operators as described above.

Inverse

You can compute a distance from a point-to-point inverse by entering <Point ID>,<Point ID>.

Example

1,2

Using the coordinates listed below, the result is 500'.

Pt.	North	East
1	5500	5000
2	5000	5000

STATION

The station control will display the value using the current Job Settings format. The same options described above for distance input boxes apply.

SLOPE

The slope control will display the value using the current Job Settings format.

Keyboard Operation

Carlson SurvCE allows the user to operate the interface entirely from keyboard navigation, as well as touch screen navigation. The rules for keyboard navigation are outlined below:

Controls

- **Button (Radio Buttons, Check Boxes and Standard Buttons)**
 - **Enter:** Select the button.
 - **Right/Left Arrows:** Move to the next tab stop.
 - **Right** [Tab]
 - **Left** [Shift+Tab]
 - **Up/Down Arrows:** Move to the next tab stop.
 - **Down** [Tab]
 - **Up** [Shift+Tab]
 - **Tab:** Move to the next tab stop.

In Menus like Job Settings, Tab Right and Tab Left move through the tab headings (New Job, System, Format, Options, Stake) along the top of the dialog, while the right and left arrows move up and down through the options within each tab.

- **Drop List**
 - **Enter:** Selects the highlighted option within each drop list.
 - **Right/Left Arrows:** Move to the next tab stop.
 - **Right** [Tab]
 - **Left** [Shift+Tab]
 - **Up/Down Arrows:** Move through the list items.
 - **Tab:** Move to the next tab stop.
- **Edit Box**
 - **Enter:** Move to the next tab stop. For any measurement screen, if focus is in the description edit box, take a reading. For all other edit boxes, ENTER moves through the tab stops.
 - **Right/Left Arrows:** Move through the text like standard windows.
 - **Up/Down Arrows:** Move to the next tab stop.
 - **Down** [Tab]
 - **Up** [Shift+Tab]
 - **Tab:** Move to the next tab stop.
- **Tab**
 - **Enter:** Move to the next tab stop.
 - **Right/Left Arrows:** Move through the tabs.
 - **Right** Next Tab
 - **Left** Previous Tab
 - **Up/Down Arrows:** Move to the next tab stop.
 - **Down** [Tab]
 - **Up** [Shift+Tab]
 - **Tab:** Move to the next tab stop.

Abbreviations

- Adr: Address
- AR: Angle Right
- Avg: Average
- Az: Azimuth
- Bk: Back
- Calc: Calculate
- Char: Character
- Chk: Check
- cm: Centimeter
- Coord(s): Coordinate(s)
- Ctrl: Control

- Desc: Description
- Dev: Deviation
- Diff: Difference
- Dist: Distance
- El: Elevation
- Fst: Fast
- ft: Foot
- Fwd: Forward
- HD: Horizontal Distance
- HI: Height of Instrument.
- Horiz: Horizontal
- Ht: Height or Height of Antenna with GPS.
- HT: Height of Target.
- ID: Identifier
- ift: International Foot
- in: Inch
- Inst: Instrument
- Int: Interval
- L: Left
- m: Meter
- No: Number
- OS: Offset
- Prev: Previous
- Pt: Point ID
- Pts: Points
- R: Right
- Rdg: Reading
- SD: Slope Distance
- Sta: Station
- Std: Standard
- Vert: Vertical
- ZE: Zenith

FILE

This chapter provides information on using the commands from the File menu.



Job

This command allows you to select an existing coordinate file for your job or to create a new coordinate file. The standard file selection dialog box appears for choosing a coordinate file, as shown in the next figure. Buttons for moving up the directory structure, creating a new folder, listing file names and listing file details appear in the upper right corner of the dialog box.

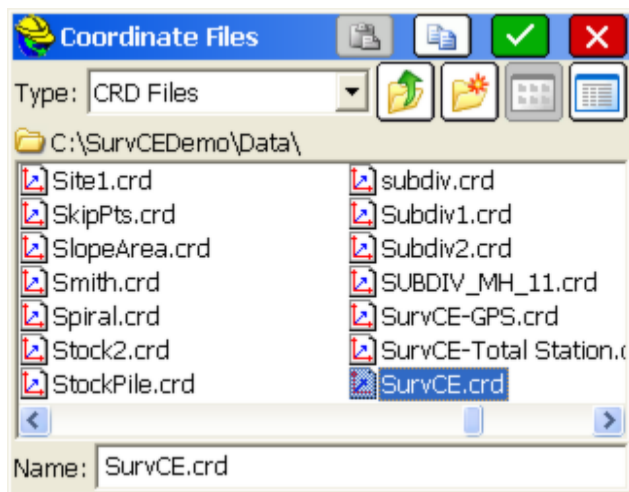

All data points you collect are stored in the coordinate (.crd) file you select or create. The .crd file extension will automatically be appended to the file name.

SurvPC, the PC version of SurvCE, additionally permits the direct loading of .dwg files, ArcMap doc files (.mxd extension) and Microstation drawing files (.dgn extension). With SurvPC, these alternate file types are loaded by selecting the options under "Type" in the upper left.

Select Existing Job

To select an existing job, browse to and select an existing file, then select **OK** (the green check icon).

Create a New Job

To create a new job, simply enter a new name and select OK. You can control where your job is saved by browsing to the desired folder where the job is to be created before entering the new name and selecting OK. You can also create a new folder for this new file name. Following job creation, you will be asked to enter in Job Attribute information. This feature lets you set up prompting for each new job with job-related attributes like Client, Jurisdiction, Weather Conditions and the like. The information is stored in the raw file. This is discussed in detail in the Job Setting section.

Copy and Paste Job

The Copy icon at the top of the dialog let's you copy an existing file and then paste it with the Paste icon into a different directory, as selected.

Note: If you key in a coordinate file that already exists, it will load the file instead of overwriting it with a new file. The benefit of this feature is that you cannot accidentally overwrite an existing coordinate file from within Carlson SurvCE.

Job Settings (New Job)

This tab allows you to configure how all new jobs will be created.

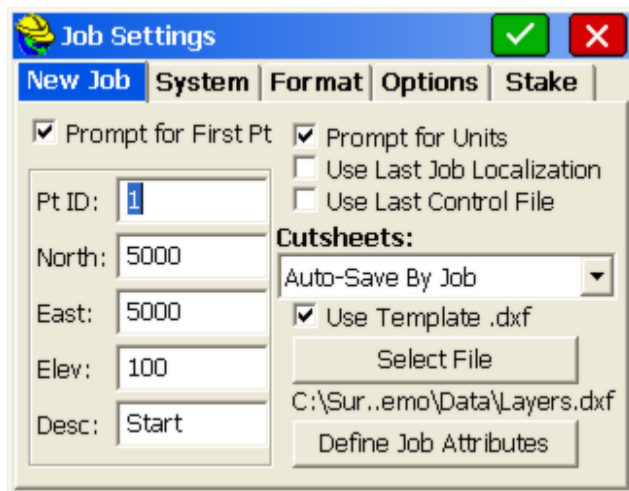

- **Prompt for First Pt:** This option specifies whether or not SurvCE will

prompt you to specify a starting point when starting a new job. If enabled, you specify the default starting point coordinates in the left column. This applies for total station use only.

- **Prompt for Units:** This option specifies whether or not SurvCE will prompt you to set the units when you start a new job.
- **Use Last Job Localization:** If this feature is enabled, each new job will use the previous job's localization file and project scale. If this feature is disabled, each new job will start out with no localization and a project scale of 1.0. The default value is off.
- **Attach Last Control Data:** This allows the user to use the same control file on all new jobs. With this option off, the control file will automatically be deactivated during new job creation.
- **Cutsheets:** Cutsheets are reports of cuts and fills based on stakeout (setout) commands. Auto-Save by job will automatically create cutsheet files (in the last format used) for each new job. If your job was named Macon1.crd, then the first 3 cutsheet files created would be Macon1-Pt.txt (for non-alignment, point-only stakeout), Macon1-CL.txt (for stakeout involving alignments) and Macon1-Sl.txt (for slope staking). Auto-Save by Job & Date will include the date in the job name. Recall Previous will allow the user to use the same cutsheets on all new jobs. With Manual, the control file will automatically be deactivated during new job creation and you will need to create cutsheet files within the Stake tab of Job Settings. Cutsheets normally store in ASCII (*.txt) format but can store in EXCEL (*.csv) format if selected within Job Settings, Options.
- **Use Template DXF:** This allows users to create an empty DXF file that contains all of the layers and colors that will be used and displayed in the field. The feature works well with use of Feature Codes for linework. If you designate code 201, for example, as a pavement edge in the layer BitPav, you could make a blank DXF drawing with BitPav layer created, set to color blue. Then using that "template dxf" file, everytime you code a 201, you will see the blue linework as an extra confirmation of correct coding. This color-coding could be repeated for other often used layers.
- **Define Job Attributes:** This lets you set up prompting, for each new job, for job-related attributes like Client, Jurisdiction, Weather Conditions, Party Chief and other notes. These will prompt when each new job is started, and the attributes and entries will appear in the raw file (.rw5) file. Select Add to enter new attributes.

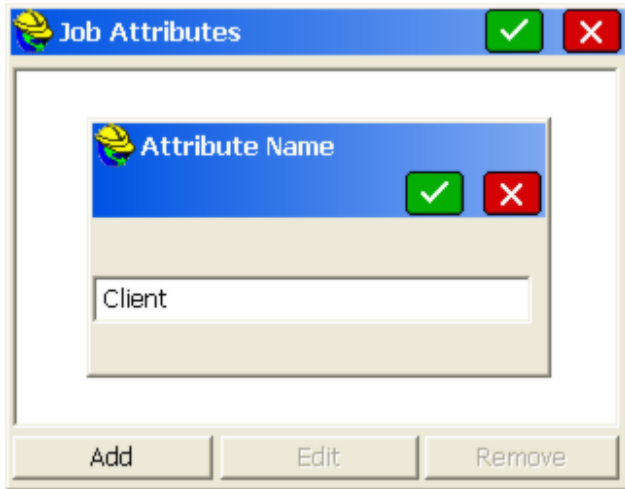

Job Settings (System)

This tab allows you to define the units for the current job.

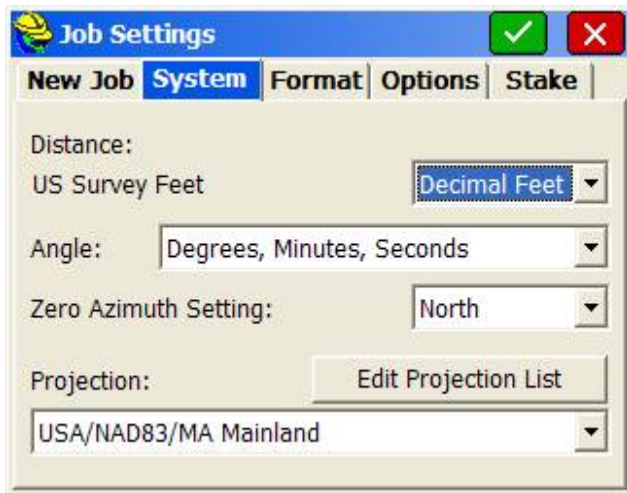

- **Distance:** Select the units that you want to use. Choices include US Feet, International Feet, and Metric. If US Feet or International Feet is selected, you have the option to display distances as decimal feet (Dec Ft) or Feet and Inches (Inches). This is a display property only and will not change the format of the data recorded to the raw file. Once distance units are selected for a new job (meters vs feet), they cannot be changed, except for selection of decimal feet versus feet and inches in the case of measurement in feet. If you want to select another unit of measurement, create a new job and if necessary, import the coordinates, linework and symbols as desired. Convert entities

and points between meters and feet using options within Cogo, Transformation, Scale or Align.

- **Angle:** This offers the option of degrees (360 circle, 60 minutes to a degree and 60 seconds to a minute), decimal degrees and gons (also referred to as grads- 400 circle and fully decimal). An angle of 397.9809 gons is equivalent to 358 degrees, 10 minutes and 58 seconds. (Note: you can verify this in Cogo, Calculator, Conversion tab). Angle measurement in Mils is also provided for military applications, where each mil represents 1/6400 of a circle (standard in NATO countries). The Angle Unit configuration impacts commands such as Inverse, Traverse, Sideshot, Input-Edit Centerline and other commands where a direction is displayed or entered.
- **Lat/Long:** Options are for degrees, minutes, seconds and decimal degrees, impacting all latitude and longitude displays and entries, such as in Equip, Localization.
- **Zero Azimuth Setting:** Allows you to specify the direction for zero azimuth, North or South.
- **Edit Projection List:** You can create a short list of commonly used projections that appear in the pulldown list. This is done by selecting projections from Predefined choices, per the menu option below. Predefined choices include NAD 27 and NAD 83 for the United States and UTM for projections around the globe, as well as individual country projections. Although UTM selections include every UTM zone spanning the globe, one advantage of the UTM Automatic Zone Selection is that your local Latitude and Longitude will be used to automatically set the zone, in case you do not know which UTM zone to use. You can also Add User Defined projection systems, where you enter the New System name, choose the Projection type from an extensive list, then enter all the information requested such as False Northing, False Easting, and the items within "New Datum".

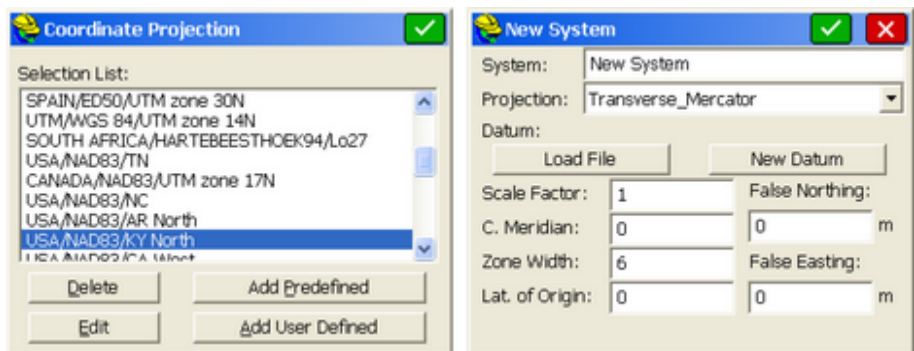

Note: The Projection selection applies primarily to GPS work and your localization file. It enables automatic calculation of scale factors for grid to ground and ground to grid, for example (See Localization). However, the Projection can also apply to total station work. When you do any processing of your data within the Raw Data option (File Menu), there is an option "Reduce to

Grid Coordinates". If this option is turned on, then the position on the projection is calculated for each point in the traverse and for each sideshot, and leads to a specific grid factor. The grid factor, combined with the elevation factor, leads to computation of the combined factor, which is applied to each traverse and sideshot. The program then calculates the fieldwork at sea level on the projection (ground to grid). This can improve your closures especially when traversing from one known grid system monument to another. Selecting and applying the correct projection is also useful when trying to match total station measurements (often located on the ground) to GPS-based survey work (typically located on the grid, at sea level).

Job Settings (Format)

This tab allows you to select the viewing format of the data displayed and entered in the current job.

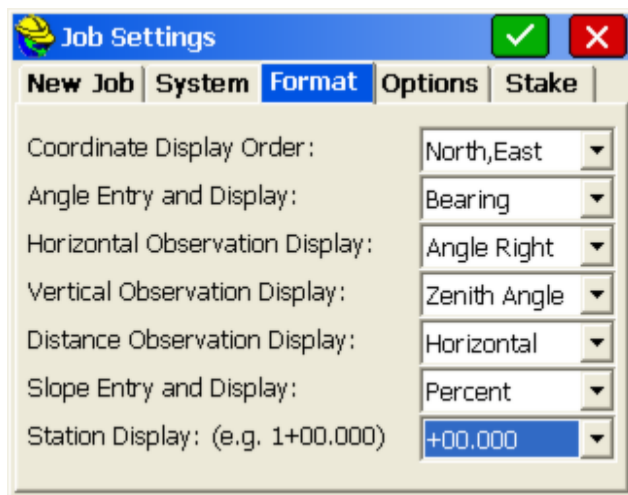

- **Coordinate Display Order:** This option allows you to display coordinates with the order of North then East or East then North.
- **Angle Entry and Display:** Options are Bearing or Azimuth. This applies to numerous commands, such as prompting and displays in Sideshot, Traverse (the backsight as azimuth or bearing), Intersections, and Inverse.
- **Vertical Observation Display:** Allows you to set the default prompting to Zenith (0 degrees up, 90 degrees level), Vertical Angle (90 degrees up, 0 degrees level) or Elevation Difference (up is positive in absolute units, down is negative). Normally combine Elevation Difference with Horizontal Distance. If combined with Slope Distance, the non-zero Elevation Difference will be used to compute the equivalent zenith angle and will reduce the Slope Distance to a lesser Horizontal Distance. (Applies to entries in Manual Total Station mode).
- **Distance Observation Display:** Options are Slope or Horizontal. This

applies to the values displayed from total station readings.

- **Slope Entry and Display:** Whenever slopes are reported or prompted, you have the option to specify the default in Percent, Degrees or Ratio. Some commands such as 3D Inverse will automatically report both slope and ratio and are unaffected.
- **Station Display:** This option impacts the display of centerline stationing, sometimes referred to as “chainage”. In the U.S., for example, roads designed in feet are “stationed” by every 100 feet, so that a road at linear position 14280.5 is given a station of 142+80.50. Metric roads in the U.S. are often stationed by kilometers, where the same road position has a station of 14+280.500. You can configure the placement of the “+” as desired, independent of your configuration for metric vs feet units. You can also configure for a purely decimal display of stationing/chainage, as in 14280.500. This display form shows up in such commands as Input-Edit Centerline, within the Start Station dialog box. Please note that you should still input the stationing in purely numeric form, without the “+” convention. Only the display is impacted by this option. Note how the example within parentheses changes with each selection.

Job Settings (Options)

This tab allows you to set configuration options for the current job.

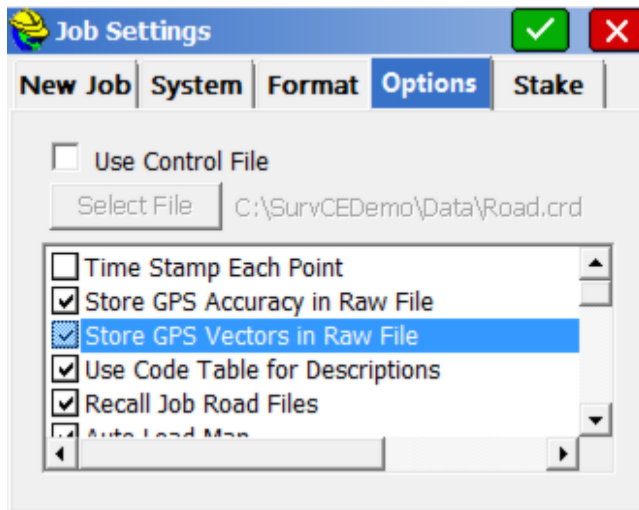

- **Use Control File:** The control file is used for selecting and using points that don't exist in your current working file.
- **Select File:** Select the control file to use. The chosen file appears, and will remain as the default control file, even when the control file option is disabled (in which case it is grayed out).

General Rule: Carlson SurvCE will always look for the defined point in the current working file first, and then the control file. If the point is not found in either file, a warning that the point does not exist will be

displayed. You can force a point to come from the control file or the current file, regardless of settings, by using the List icon to the right of the point ID input box. While in the point list selection window, select the Control file button prior to selecting the desired point.

Stakeout Option: Control files work similarly in stakeout. However, you can go to the STAKEOUT tab in Job Settings and set the program to give priority to the control file points when duplicate points exist. If this option is turned on, and the selected point is found in both files, you will actually be staking out the point from the control file.

Coordinate File Rule: At no time will a point be automatically copied from the control file into the current file. This allows users to avoid large gaps in coordinate files and eliminates the potential for conflicting points.

Raw Data File Rule: Any time a point is occupied, the occupation record (OC) is written to the raw file for processing purposes. There will not be an SP record written for control file points, only an OC record. Note that if the raw file is reprocessed, the point will be written to the current coordinate file.

- **Time Stamp Each Point:** When enabled, a date and time stamp will be noted in the raw file beside each point. Raw files in Carlson SurvCE have a .RW5 extension and are nearly identical to the TDS .RW5 format. See the image below for simple SurvCE .RW5 file.

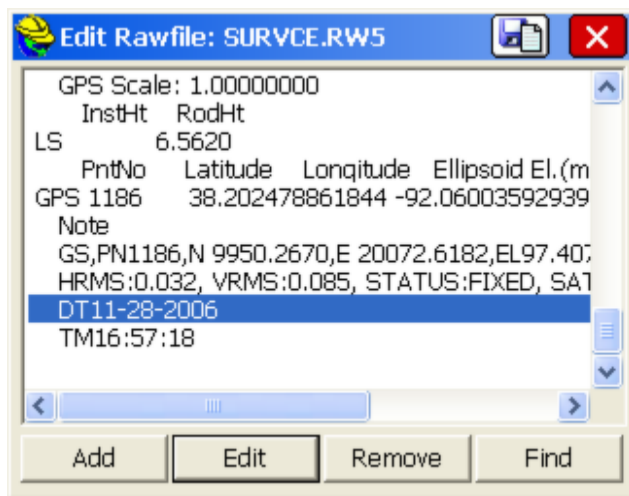

- **Store GPS Accuracy in Raw File:** This option is available when configured to any GPS equipment. If enabled, the horizontal and vertical quality as reported by the GPS will be stored to the raw file with each point. The terms may vary by receiver type: (eg. HRMS/VRMS, HSIK/VSIG or CEP/SEP typically).
- **Store GPS Vectors in Raw File:** The GPS vectors option is a form of raw data for GPS measurements, similar to angle and distance data for total stations. The vectors refer to the distance and azimuth from the base receiver

or virtual reference station base to the rover. These vectors can then be used by any Network Least Squares program such as Carlson SurvNet, which is part of Carlson Survey office software. They may also be utilized optionally in Post Processing, such as in the Carlson SurveyGNSS program. Finally, vectors are essential to utilize the GNSS Analysis feature within the Cogo Menu, Point Average. The vector option is available on most GNSS receivers, but not all. Many manufacturers are in the process, however, of adding access to the GNSS vectors allowing Carlson SurvCE to store the vectors in the raw file. Examples of receivers that provide access to the vectors include Altus, the Carlson Surveyor+ GPS, Topcon, Leica, StonexS8 Plus, S9III, Trimble Promark SP80, Geomax Zenith 20, CHC and Satlab.

- Use Code Table for Descriptions:** This feature activates feature code usage. If on, feature codes can be used to draw symbols and linework within specific layers. Special code icons also appear when "Hgt/Desc Prompt on Save" is on (within Equip-Configure). If "Use Code Table" is clicked off, use of feature codes is disabled and no linework or symbol drawing will occur. When clicked off, only the current descriptions used in the current job will appear. Most users will turn on the "Use Code Table" option and access the power of the feature codes. Only users who do not want linework and symbols and only wish to see the specific descriptions in their current, active job will benefit from turning off "Use Code Table". When clicked off, only the previously used descriptions within the active job appear for re-use by picking.

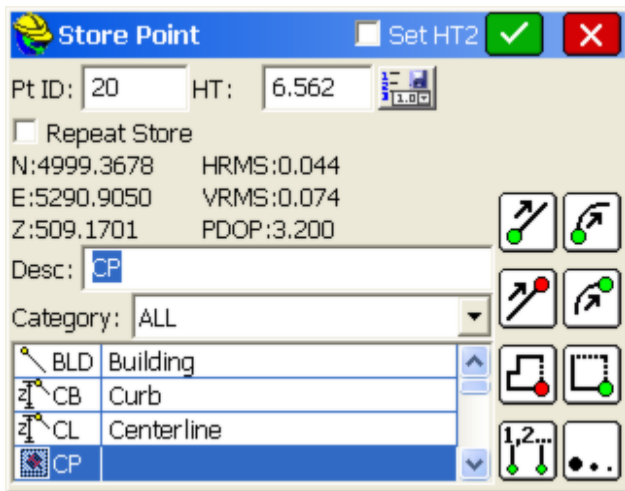

- Recall Job Road Files:** This command only applies to Stakeout Centerline, Offset Stakeout, and Point Projection in the non-riding version of Carlson SurvCE. When enabled, this option will recall the last roading files (centerlines, profiles, templates, superelevation files, etc.) used in road stakeout. Routines in the Road menu such as Stake Road and Slope Staking will automatically recall the last-used roading files.
- Auto Load Map and Auto Save Map:** Maps can be viewed in the MAP and Graphic views within Carlson SurvCE. These maps can be created by using

the command IDXF which imports a DXF drawing file. AutoCad DXF formats 12 through 2010 are fully compatible and will import. Microstation DXF files and DXF files from other CAD programs will also work. Linework (referred to as polylines) can be produced within the MAP view by using the PL (polyline) command, or other commands such as Offset (O2 and O3). In addition, use of Feature Codes, where linework is associated with field codes such as EP for edge-of-pavement, will lead to the drawing of polylines in the Map view. These maps can then be auto-saved whenever you exit a coordinate file, and auto-loaded whenever you load a particular coordinate file. The maps are saved in DXF format. It is typical to enable both Auto Load Map and Auto Save Map if you want to auto-recall your latest map. If Auto Load Map is on and Auto Save Map is turned off, you will recall the map that was saved previously—when Auto Save Map was on. If you want to start your map from a clean slate (from the point plot only—which always appears in map view), you can turn off Auto Load Map and re-enter the program. Then add polylines, use IDXF to import maps (polylines), then click on Auto Save Map and Auto Load Map and you will store and recall only the new linework.

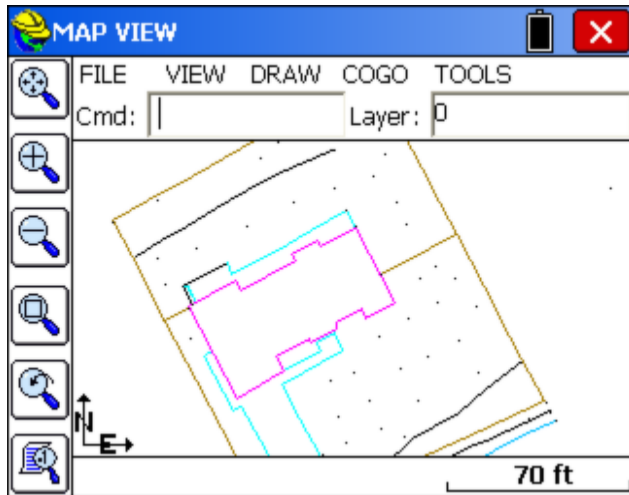

Note: The above graphic display is default. In the Map screen, the normal display includes pull down menus. These can be disabled by selecting Preferences under the File menu, which expands the map area. The Preferences screen below shows the display options. The pull down menu format is recommended.

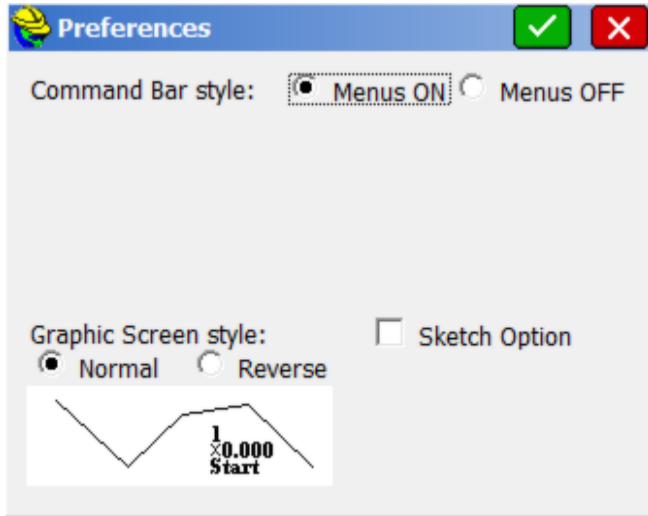

- Recall World Image (Image Database):** Similar to the DXF file used for new jobs, this option would recall and place an image database background screen, such as an aerial photo, on each new job or existing job. Whatever image is actively displayed when the option is selected will be displayed when other jobs are loaded. If no image is active when the option is selected, then it has no effect. This would be useful for repeated new jobs where a particular aerial photo graphic is needed for reference. The actual graphic used is set within the Map screen, Tools menu, option Image Overlays, Use Image Database.

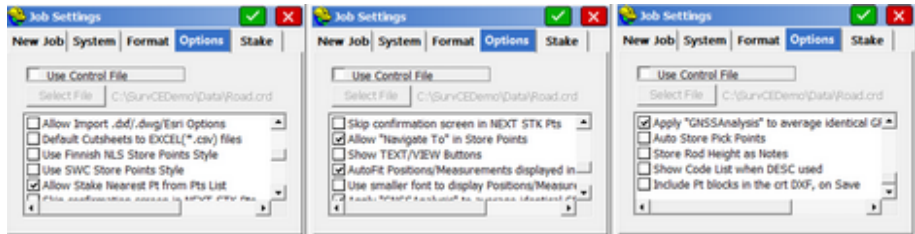

- Allow Import .dxf/.dwg/Esri Options:** This creates additional options within the Map Screen, Import of .dxf and .dwg files. If .dwg files are created by the ArcMap command "Export to CAD", these files can be imported with attribute data using Import .dwg, if this option is turned on. For both .dxf and .dwg files, AutoCAD point entities can be detected and imported as point entities, and even stored to SurvCE point IDs as an option. New since SurvCE 3.0, blocks and inserts can be imported from .dxf and .dwg files, allowing accurate surveying and stakeout using the "center" point snap. SurvCE 4.0 and higher allows the importing of Text. Be aware that all of these special Import options can add dramatically to the drawing size if activated. The dialog below does not appear unless this Job Settings option is clicked on, and only lines and polylines will import in that case.

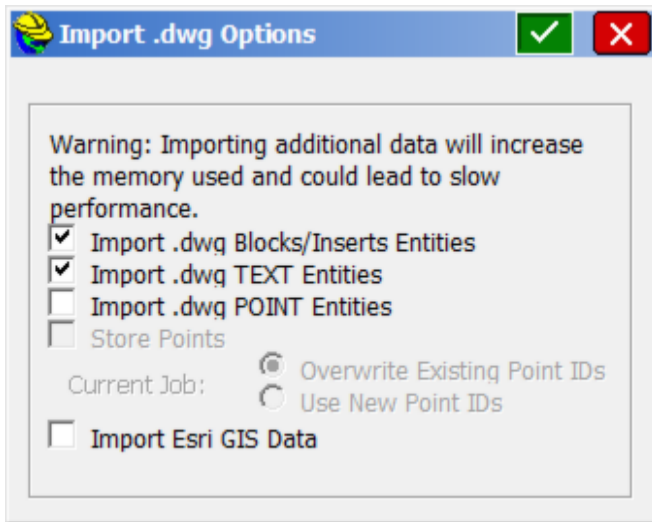

- **Default Cutsheets to EXCEL (*.csv) Files:** Stores Cutsheets in *.csv (EXCEL) format.
- **Use Finnish NLS Store Points Style:** Applies specifically to file formats used in Finland.
- **Use SWC Store Points Style:** This special style, although designed for particular companies, may have some general application. This option is designed for numeric field codes (eg, 10, 11, 101, 102, etc.). Although the screen appearance of the points is not altered, with this option clicked on, two preset GIS attributes are established.

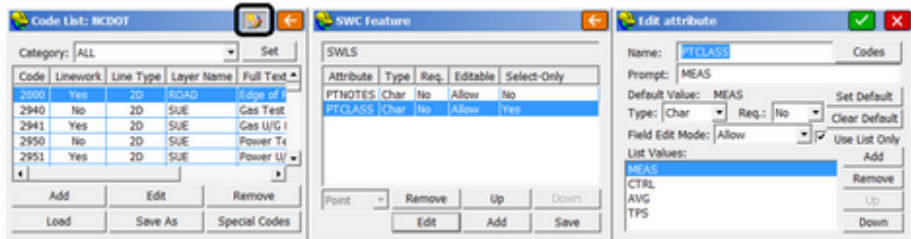

A special icon appears as shown above left within Feature Codes command, which when clicked, leads to the 2 preset attributes for each point. Also preset within PTCLASS are 4 selectable class values (measured, control, average and TPS). All of these attributes can be edited or added to. The attribute prompting applies only to field-measured points, not points created in the Map Screen with the Create Points command. If "Time Stamp Each Point" is on within Job Settings (described above), then use of the "SWC Style" leads to a specially formatted point list when Export ASCII file is used. There, the SWC option leads to the format below:

Pt ID, Northing, Easting, Elevation, Feature Code, Action Code, Description, Date, Time, HRMS, VRMS, PtClass, Measurement Code /Backsight Prism Offset/Foresight Prism Offset

The prism offsets in the ASCII Export file apply only to the "TPS" point class or total station measurements.

- **Allow Stake Nearest Pt from Points List:** Within Stake Points, points can be selected and added into a "stakeout list". With "Allow Stake Nearest.." on, as each point from the list is staked out, the nearest point to the last one staked will be selected next. This reduces the distance to move with each stakeout. However, by targeting the next nearest point, you may move in a direction where the last few to stake are behind you and relatively far away.
- **Skip Confirmation Screen in NEXT STK Pts:** Within Stake Points and other commands that allow "N for Next" (to move to Next point in order or to move to Next alignment point to stake), the screen confirming the point or station to stake is omitted for faster field stakeout.
- **Allow "Navigate to" in Store Points:** Selecting this option brings up two icons in the upper left of the Store Points screen, which allows Navigate to a picked point and Navigate along a path defined by a series of picked points. This enables simultaneous navigation and storing of points within the Store Points command. Shown below is use of the left-most icon (Navigate to Point) within Store Points. Note that an effective "View" Method within Configure is Deflection/Distance. A deflection left as shown would put you on line towards the selected point. When selecting a point to navigate to, by snapping, the ? snap allows you to pick a point in blank space, anywhere.

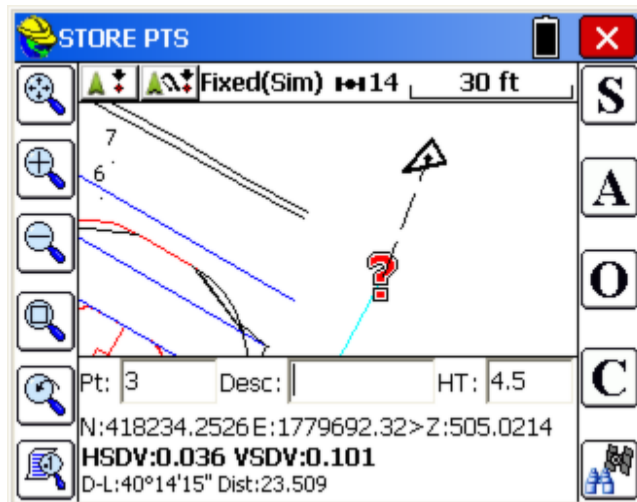

- **Show TEXT/VIEW Buttons:** When clicked on, Store Points will show a TEXT button in the upper left to allow clicking into the Text screen for storing (no graphics, just large print data) and Stakeout screens will offer the

View button in the upper left leading to a special large text stakeout screen (shown below). Once in Text mode, the normal graphic screen mode can be selected using the Helmet options (icon in upper left) by selecting "Graph". Text mode itself can always be chosen using the Helmet in addition to the configurable "Text" button.

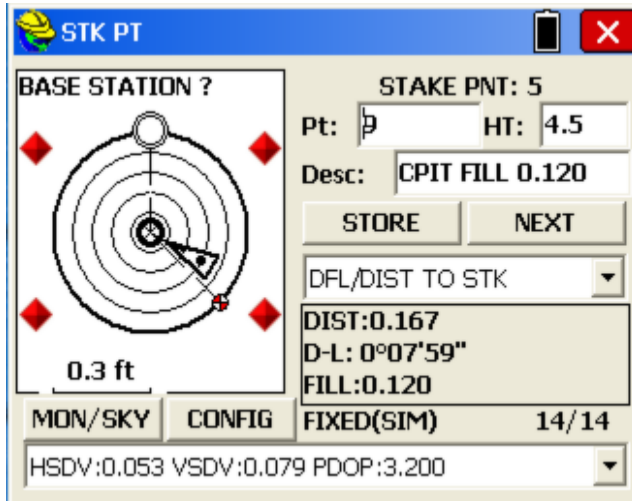

- Auto-Fit Positions/Measurements displayed in the bottom bar:** With this option turned on, the number of decimals shown for either the Northing or Easting (depending which number is larger), or both, are reduced in order to fit the North, East and Elevation data on one line underneath the graphic display, within Store Points and the stakeout commands. In the example below, the Easting is reduced to 2 decimal places, from the standard 4 decimal places. With this option off, some clipping or overwriting of the numbers may occur as the program tries to display all data to 4 decimal places. Note that the "Text" button is on below, per the previous Job Setting option, which provides a second way of switching to "Text Mode" in addition to the "Text" option within the Helmet icon (upper right). Currently, the screen is in normal "Graph" or map mode.

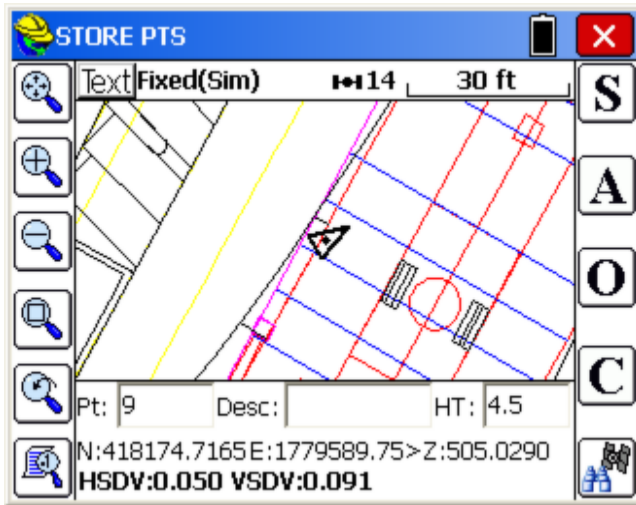

- **Use smaller font to display Positions/Measurements in the bottom bar:**
 Instead of reducing the number of displayed decimal places to fit all N,E,Z data, the program reduces the font size to fit the data:

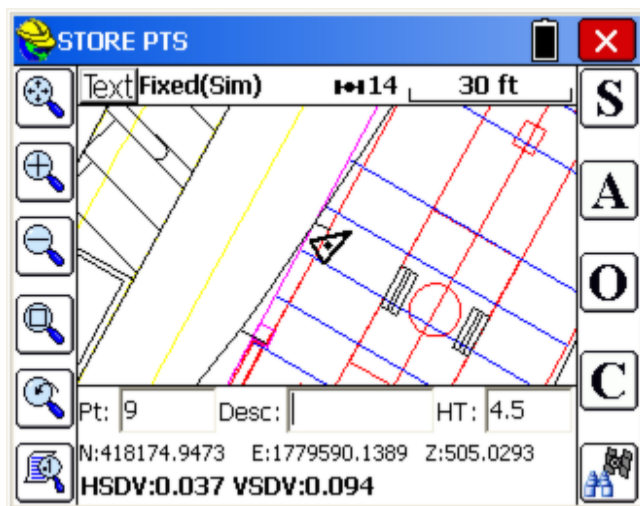

- **Apply "GNSS Analysis" to Average GPS Points with Identical IDs:**
 Within the command **Point Average** in the **Cogo** (coordinate geometry) menu, this option introduces a distinct averaging method for GPS measurements that applies a Chi Square analysis using vector data to the identical points, as read from the raw file, and includes blunder detection and blunder point removal. Points collected individually within Store Points, or by A for average within Store Points, sharing the same point ID, will be averaged by statistical methods including estimates of accuracy, which under most conditions of measurement will exceed normal RTK accuracy. This option can be viewed as a form of post-processing in the field, leading to

greater accuracies. Be sure that "Store Vectors in Raw Data" is turned on (above, in Job Settings). Your GNSS equipment needs to have the vector storage option available. Furthermore, it is advisable to turn on, within the Hgt/Description prompt, "Avg Same Pt ID". Once this is clicked on, the Hgt/Description prompt itself can be turned off (to reduce prompts in the field) using the Configure command (C for Config or Equip-Config).

- **Auto Store Pick Points:** With this option turned off, when you select line or polyline endpoints when defining alignments using the Map button selection (highlighted below), no new point IDs are created. Selections are referred to as "picked point 1" (PP,1) and "picked point 2" (PP,2) temporarily and then discarded.

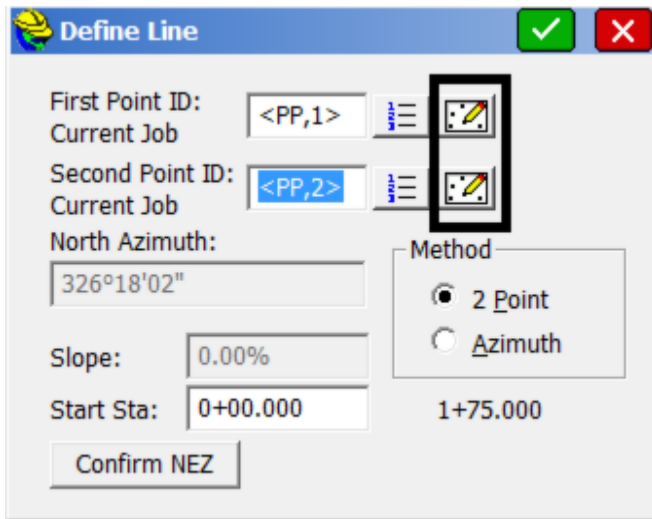

Similarly, with Auto Store Pick Points off, no new points are created in the screen view or in the file when selecting line elements for stakeout.

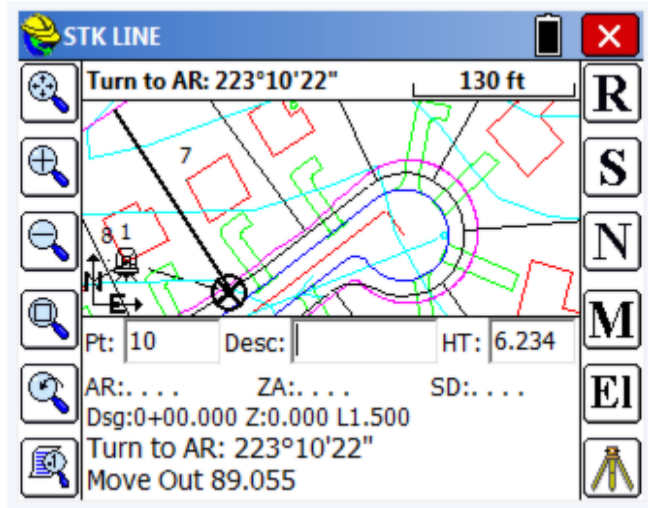

But with this option on, new points are associated with the screen-selected alignment when picked using the "from Map" snaps. Note that the "down arrow" option was used to expand the graphic screen viewing area. The "angle right" instructions are still seen at the top of the screen.

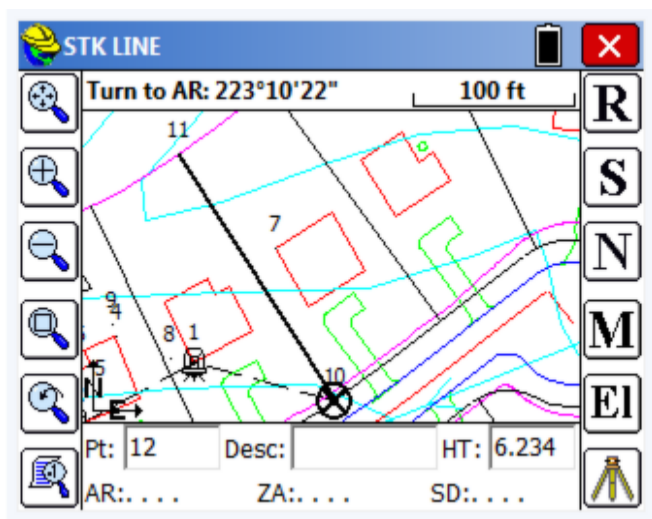

- **Store Rod Height as Notes:** With this option on, the Rod Height is stored in the note file associated with the job in addition to being stored in the RW5 file.
- **Show Code List when DESC Used:** This very useful setting allows faster field operation by eliminating the need for Prompt for Height/Description on (in Equip, Config, or set by C button for Configuration). The Height/Description prompts is preferred by many surveyors to double-check the rod height and to pick the default feature code and same-day used

descriptions from a list. But this involves an extra screen to appear. If you turn off Prompt for Height/Description, you can save a screen, and with "Show Code List when DESC used" On, you can get the description field in the single point measurement screen. For example, with this option off, a description would need to be entered (see graphic above). But with this option on, you get a "From List" icon and can select the desired description with a single pick (see below). This appears not only in Store Points but in Stake Points (when storing points) and in any command where points are stored.

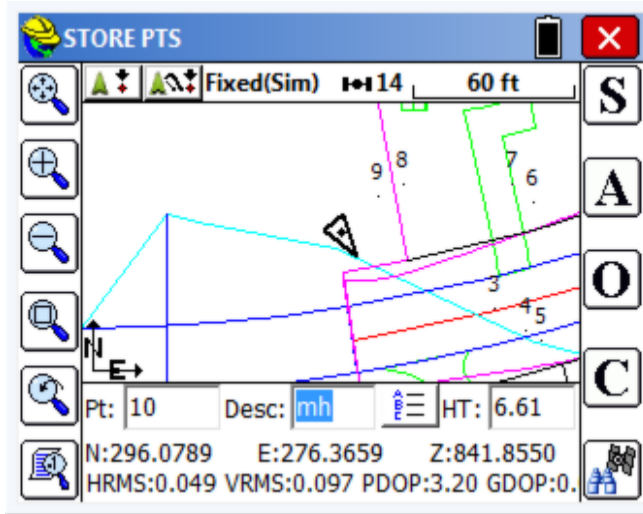

- **Include Pt Blocks in the current DXF on Save:** It is recommended to keep this option clicked off, unless you want to DXFIN the point blocks themselves into an external CAD program. This feature, new with SurvCE 4.0, can drastically reduce the time to save and load jobs. If a job has 2000 points, not only the linework and blocks (symbols) on the screen are saved to the DXF file, but also the point graphics can be saved to the DXF file, making it larger and slower. But since the point graphics, in effect, duplicate the points themselves in the CRD file, they are redundant and typically unnecessary to be saved in the DXF drawing when using SurvCE. So click this option OFF to speed up saving and recalling jobs, since the points will load quickly and display on their own directly from the CRD file itself.
- **Allow GIS Data Prompting for STK Points:** With this option clicked on, you get an extra prompt when staking out to select GIS attributes to associate with the staked points. Then whatever the GIS prompts are for the feature code, they follow on the next screen(s). Here is how this appears:

Stakeout Report ✓ ✕

	Northing	Easting	Elevation
Staked:	344.920	304.400	841.861
Design:	344.918	304.378	841.841

Move: In 0.016 ft
 Left 0.016 ft Cut 0.020

VOff 1: Elv:

VOff 2: Elv:

HRMS:0.047 VRMS:0.082 PDOP:3.200

Store Point Point ID:

Set GIS a-z

Add GIS Data RM ✕

10 [Point] Save Values

(Char) Status

▼

Job Settings (Stake)

This tab allows you to set configuration options for the stakeout routines.

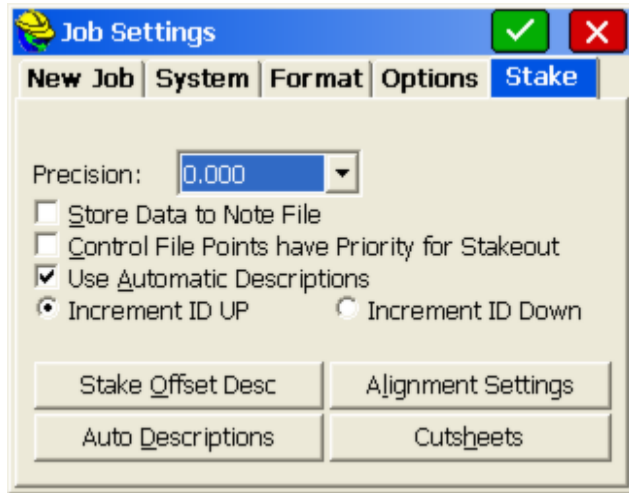

- **Precision:** Use this to control the decimal precision reported during stakeout routines.
- **Store Data to Note File:** This option specifies whether or not to store the stakeout data in the note file (.NOT) for the current job. At the end of staking out a point, there is an option to store the staked coordinates in the current job. Note (.NOT) files are associated with points, so you must store the point to also store the cutsheet note. This additional data includes the target coordinates for reference. Keep in mind that the cut and fill data is also stored in the raw file. You can also store an ASCII cutsheet file using the button at the bottom of the dialog, so storing into the note file is somewhat redundant. SurvCE does not show the cutsheet note within List Points (notes turned on), since this feature only shows notes that begin with "Note:." The one advantage of the note file is that notes are viewable in association with points using Carlson Software office products such as Carlson Survey. See command *Cutsheet Report*, option *Note File*.
- **Control File Points have Priority for Stakeout:** This option, which applies to both total stations and GPS, will give priority to the control file point during stakeout, when the point requested exists in both the current file and the control file.

Note: Use this option with care. You may not realize that this option is set, and will discover that directions to your expected stakeout point of 10 are really based on a point 10 from another file altogether – the control file.

- **Use Automatic Descriptions:** This allows you to have descriptions automatically entered for staked locations based on the settings defined by the **Auto Descriptions** dialog.
- **Increment ID UP/Increment ID Down:** Within the Stake Points

command, you may need to stake points in decreasing order (see below). In this case, you can preset to Increment ID Down, so prompting would be 87, then 86, then 85, etc.

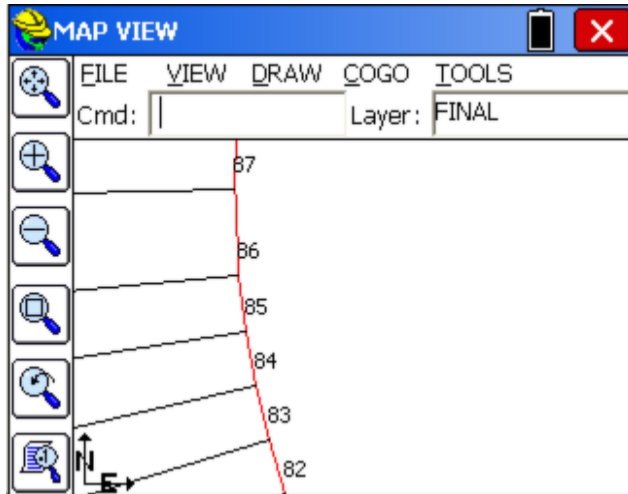

Stake Offset Desc

This allows you to define what the ID is called for each offset location in the Stake Offset routine (Surv Menu).

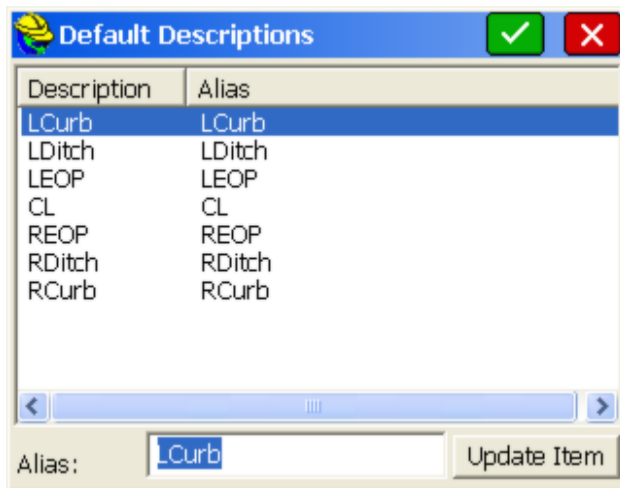

Auto Descriptions

This button allows you to configure the point description when you store points in stakeout. The very act of storing a staked point is optional. You can stake a point or a station and offset, but must click **Store Point** within the stakeout screens to actually store a point. If you do choose to store the point, the description is configurable. See image below.

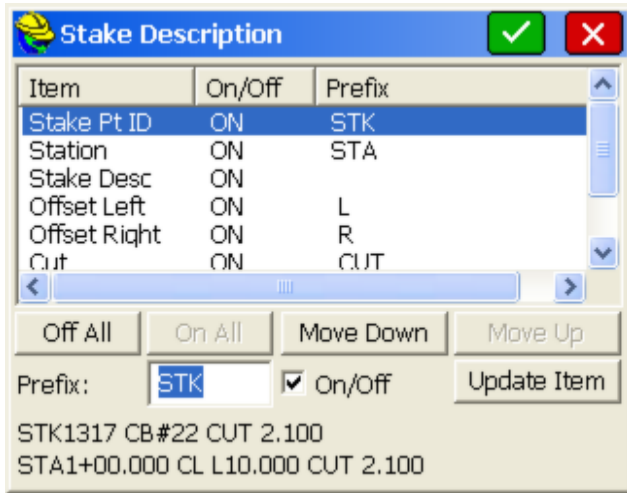

A user in Australia or Great Britain might want to change the STA for “Station” to CH for “Chainage”. An example of a typical stake description, based on your configuration settings, is shown at the bottom left of the screen. The first line (STK1317 CB#22 CUT 2.100) represents a typical Stake Point description, where CB#22 is the description you would enter, and the rest is governed by your Stake Description settings. Similarly, if centerline-based stakeout is being conducted, then the lower line would apply. The description (CL in this case) is the only aspect entered by the user in the field during stakeout. All the rest is reported based on your Stake Description settings. If you turn off an item, note how it will not appear in the reported “sample” description. The “+” in the station can also be configured to appear or not appear, but this is set globally within the Format Tab of Job Settings. The behavior of the On/Off, Up/Down and Update buttons is identical to that discussed in the Cutsheet section.

Other routines, particularly Cross Section Survey and Slope Staking (part of the Roding features), have their own settings for descriptions. When any automatic description for stakeout is turned on, the program will no longer default to the last-entered description such as “EP”; it will use the “automatic” description instead. If you type a new description, you will turn off the “automatic” stakeout description. If you delete the default (new) description, the program will return to using the automatic stakeout description. To delete, you can simply place the cursor in the description field and hit the delete key — there is no need to first highlight the description.

Alignment Settings

This dialog allows the user to define how all alignments and roads are staked.

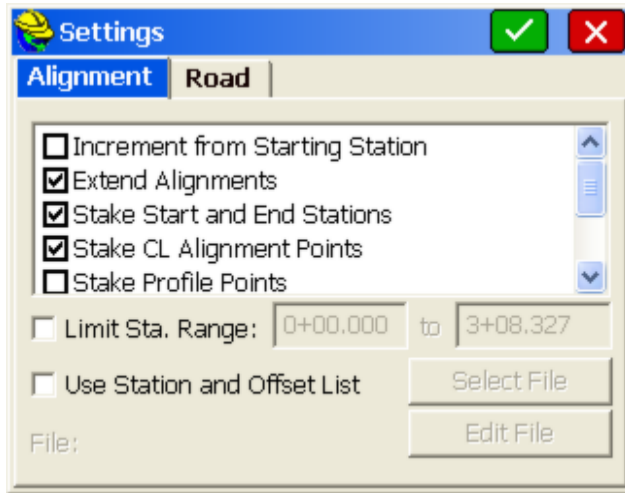

Alignment Tab (Applies to N for Next Station and all auto-incrementing of stations)

- **Increment from Starting Station:** For centerlines that start on an “odd” station such as 1020 (10+20 in U.S. stationing format), this option would conduct stakeout by interval measured from station 1020. So a 50 interval stakeout, instead of being 1050, 1100, 1150 would be 1020, 1070, 1120, etc.
- **Extend Alignments:** This projects a tangent line off of the first and last segments of the alignment for extending them beyond their defined limits.
- **Stake Start and End Stations:** This instructs the software to start and increment to these critical locations even when they do not fall on the even station.
- **Stake CL Alignment Points:** This instructs the software to stop at these critical locations (eg. PC, PT, curve-to-spiral, etc.) even when they do not fall on the even station.
- **Stake Profile Points:** This instructs the software to stop at these critical locations (eg. PVC, PVT) even when they do not fall on the even station.
- **Stake High and Low Points:** This instructs the software to increment to these critical locations even when they do not fall on the even station.
- **Template Series Station:** If a Template Series File (*.tsf) file is used, which is a series of templates applied to ranges of stations and transitioning between templates, then all stations entered in the *.tsf file for starting and ending a particular template will appear in the incrementing list of stations.
- **Combine Station Equations:** This allows the user to overlap the station equations.
- **Apply Station Equations:** If turned off, this allows the user to ignore the station equations so that the station reflects the length of the alignment.
- **Offset Gap Type: Fillet:** This allows the user to define the offset gap type used when defining offsets within Stakeout Line/Arc routine at straight

corners as: radius fillet or radius zero fillet. If turned off, the offset to the outside has fillet radius=0 and comes to a point. If turned on, the radius equals the offset and the outer intersecting offset contains an arc with radius equal to the offset.

- **Allow Reference Centerline:** With this option clicked On, a "Reference Centerline" (sometimes called "Master Centerline") icon appears in Stake Line/Arc and other alignment-based roading routines. This allows stakeout to a target alignment referencing a "master centerline" for forward-back instructions, and for reporting.
- **Remove Sta Eq when Loading SCT File:** Special feature to remove reference to station equations on loaded cross sections. Applies to Input-Edit Section File and Section File Conversion, within Road Menu, Utilities. For example, if you had 4 stations, 0+00, 0+50, 1+00 and 1+50, but had a station equation where 0+75 forward = 0+50 back, the equation is removed, and the 4 stations become 0+00, 0+50, 1+25 and 1+75.
- **Remove Sta Eq when Loading PRO File:** Special feature to remove reference to station equations on loaded profiles.
- **Limit Station Range:** When selected, the program will not automatically advance beyond the natural start and end of a given centerline.
- **Use Station and Offset List:** Use this option to load a predefined list of stations and offsets. This allows the Stake Offset routine to use a pre-defined list of station, offset, and elevation information as defined by the user. This is sometimes referred to as "Cutsheet" list. An ASCII file with a .CUT file extension is required. The file format is shown below:

```
Station, Offset, Elevation, Description, as in
20100, -11.5, 102.34,
20109.23, -11.5, 102.35, PC
```

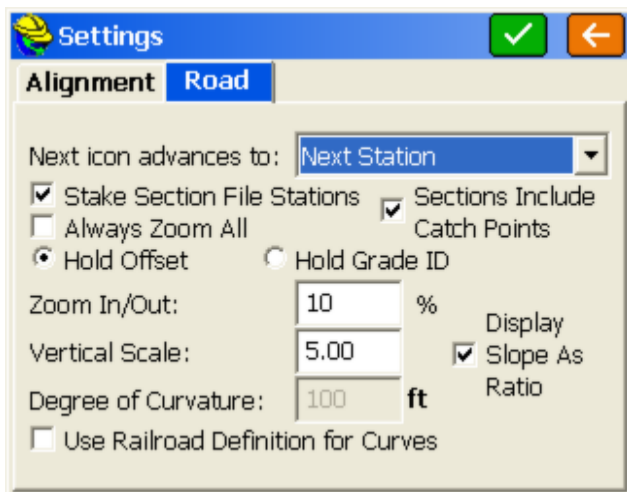

Road Tab

- **Next icon advances to:** This defines how the "Next" icon will behave. It

can advance to the next station or the next offset location.

- **Stake Section File Stations:** When ".sct" cross section files are involved, this instructs the software to stop at the stations within the ".sct" file along the alignment even when they do not fall on the even station. or other selected alignment station. If you had a cross section at station 178, the program would stake station 178 and increment to it even if that station was not a "critical" station, not a start, end, PC or other special station.
- **Sections Include Catch Points:** This instructs the software whether or not the design sections were extracted/stored to the shoulder/back-of-ditch point or all the way to the design catch location. If the design catch location is included in the section, the software will automatically determine the pivot point at the next interior section point for slope staking purposes. The design slope ratio will be determined by the last two points in the section. This applies within the command Road Menu, Stake Slope, Section File option.
- **Always Zoom All:** This zooms the preview window automatically to fit the extents of the current section.
- **Hold Offset/Hold Grade ID:** If Hold Offset is selected, the zoom holds the actual numerical offset of 12, for example, for a 12' roadway width but if Grade ID is selected, the zoom holds the calculated position of the Grade ID and factors in widening of the lane. This applies to cross section viewing within Stake Road.
- **Zoom In/Out:** This determines the zoom increment of the preview window.
- **Vertical Scale:** This allows the user to exaggerate the scale vertically.
- **Display Slope as Ratio:** Instructs the program to display ratio instead of slopes--useful for cut and fill slope display.
- **Degree of Curvature:** This allows the user to define the degree of curve base value when metric: 100 ft is the default value used for US Feet or US International Feet.
- **Use Railroad Type Curves:** This allows the user to define the use of railroad definition for the curves present within the alignment used inside the Stakeout Line/Arc routine.

Cutsheets

There can be as many as five cutsheet files active at one time, one for point staking cutsheets, one for centerline staking cutsheets, one for slope stake cutsheets, one for "grade stake" style cutsheets and finally one for the "story stake" cutsheets. The latter two (grade stake and story stake) cutsheets are described in some detail within the Stake Road command. All cutsheet files can be given distinct names, and any of them can be turned on or off for purposes of storing. And finally, if cutsheets are reported from the raw file, a distinct new name can be assigned prior to recalling the raw file and creating the cutsheet file. All cutsheet files are ASCII and can be viewed in a text editor or an Excel Spreadsheet.

The Cutsheets button leads to the following options:

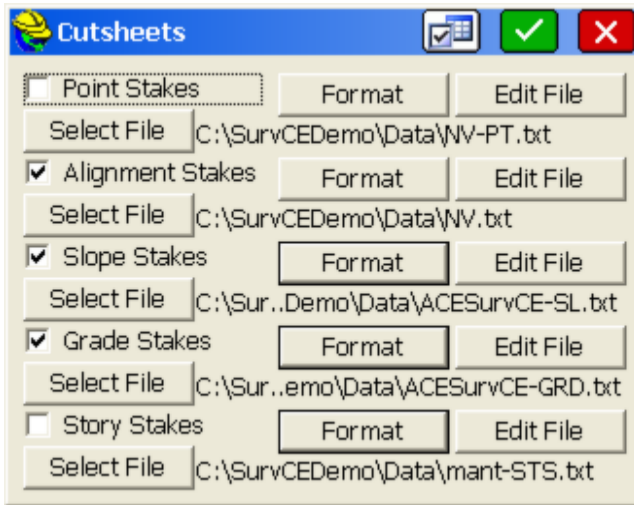

- Point Stakes:** Toggling this option on enables writing to the selected cutsheet file. The buttons allow the user to select the file, customize the Point Cutsheet report format as well as edit and view the current point cutsheet file. This applies to the command Stake Points.
- Alignment Stakes:** Toggling this option on enables writing to the selected cutsheet file. The buttons allow the user to select the file, customize the Alignment Cutsheet report format, and edit and view the current alignment cutsheet file. This applies to commands within Stake Line/Arc, and to Offset Stakeout, Point Projection and Stake Road (in Roding) and includes station and offset options in the stored file, as well as cut/fill. A special “centerline-style” cutsheet file, containing station and offset information, can be named and saved within the Roding command, Cross Section Survey. This file is viewable in the editor within Set CI Cutsheet Format, but has no cut/fill values, just “as-built” data. Centerline-based cutsheets have more configurable options in the report, such as Stake Station, Staked Offset, Design Station and Design Offset. The Design Point ID is one of the configurable items to report, and since commands such as Offset Stakeout, Point Projection and Stake Road do not stake out Point IDs, the program uses either the command name (CL for Stake Centerline, PP for Point Projection), offset reference, or template ID as the “design point name”. “RCurb”, for example, would be the name given to the design point in Offset Stakeout for top of curb, right side. This might lead to a variety of ID names for the design point.
- Slope Stakes:** Toggling this option on enables writing to the selected cutsheet file. The buttons allow the user to select the file, customize the Slope Stake Cutsheet report format as well as edit and view the current slope stake cutsheet file. This applies only to the commands Stake Slope and Stake Road available within Roding. Slope Stake Cutsheets have an extra option to “Include progressive offsets report”, and also have different options such as “Pivot Offset”, “Slope Ratio” and “Elevation: PP/CP” (Elevation of Pivot Point and/or Offset Point). Note that columns can serve a dual purpose in the slope stake report. If progressive offsets are enabled,

the header lines (such as Design Station) are ignored for the additional information, and you obtain the incremental, delta distance and elevation from each point on the section or template from the offset stake to the catch and then all the way into centerline. These last three options allow you to customize the respective output report. To change an item label, highlight the item, change the Header Label field, then tap Update Item. You can select an item in the list and turn it ON or OFF (no reporting). You can also control the order of the report items by using the Move Down and Move Up buttons. Changes must be made prior to starting a new cutsheet file.

- **Grade Stakes:** With this option on, even the Grade Stake method used for stakeout, within Stake Road, will output a specific format.
- **Story Stakes:** This will output a "story stake" cutsheet if "Story Stake" is clicked on within the Stake Road command. Cutsheets for both grade stakes and story stakes (all points in the cross section) are discussed in the Stake Road portion of the manual.
- **Select File:** Tap this button to select the output file. The file name is shown below this button.

Format

Select the format button to configure each cutsheet to your liking. Column order and column headers are completely user-defined and any column can be turned off if not useful.

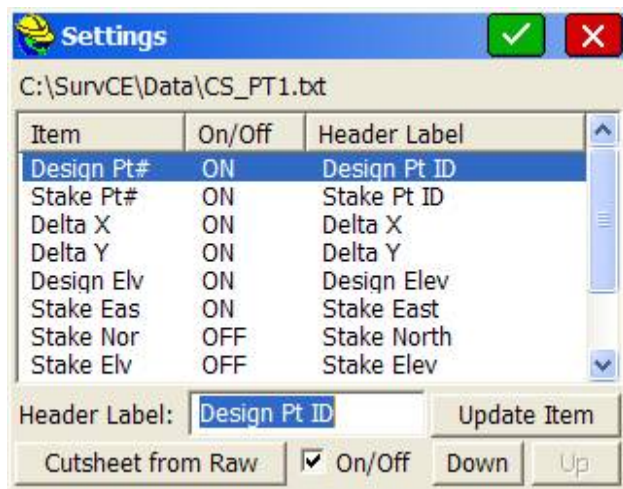

- **Header Label:** You can substitute header text of your own choice for the defaults. Here, the text Pt ID was substituted for Design Pt#. Tap Update Item after changing a Header Label. These changes should be done prior to starting a new cutsheet file—they cannot be applied retroactively to a file that already contains information. However, the header line in that file (e.g. Market.txt) can always be edited using Notepad or any text editor to accomplish the change.
- **Down-Up:** Items in the list can be moved up and down to change their

order. For example, if you prefer Fill before Cut in the report, just move Cut down below Fill.

- **Cutsheet from Raw:** SurvCE automatically stores cutsheet data and header information to the raw file for the job. You can capture and report the cutsheet information directly from the raw file. Before doing this, it is recommended that you start a new cutsheet file, configure the header lines, and order of information as desired, then run “Cutsheet from Raw”. This option is very useful if no cutsheet file was established in advance of field work. This enables a cut and fill report by reading the raw file directly.

Edit File

Select this option to edit and review the cutsheet file. Shown below is an alignment cutsheet file as viewed in the Edit File option. Notice that the vertical bars of the spreadsheet can be moved left and right to condense the display. Just pick them in the title line and move them. The Cutsheet editor also includes the ability to insert and delete lines. If you insert a line and enter a Design Elevation and a Stake Elevation, the program will compute the cut or fill. Using the **Special** button, you can increase or decrease the Pt ID, Design Elevation or Stake Elevation by any desired amount, and the cut or fill will be computed. Do not use the **Special** button to directly modify the cut or fill. If a second vertical offset is entered during stakeout, then two cut and fill results will appear for each point (useful, for example, for top and bottom of curb).

Stak...	Staked STA	Staked Off	Cut	Fi
13	80.0008	Right 20.006		0
13	80.0008	Right 20.006	0.55	
14	83.9993	Right 14.002	1.88	
14	83.9993	Right 14.002	2.46	
53	0+00.009	Right 13.006		4
53	0+00.009	Right 13.006		4

Settings Button

Select this for additional format controls for the cut and fill report.

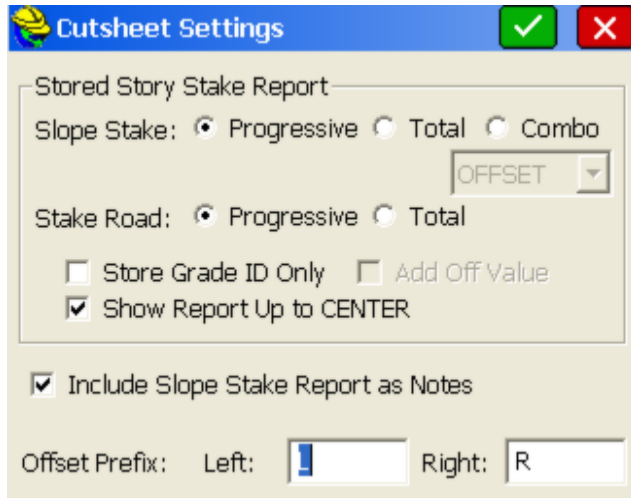

For the "story stake report", which is a report of all cut/fill and distance information to each break point on the target cross section, options for the slope stake report within Stake Road include "Progressive" or individual distance between break points, Total distance from the staked point to each break point and Combo. The "Combo" option shows a "progressive", incremental slope ratio for each segment (last column), combined with a total HDist and VDist measurement to each point. For the Slope Stake Option, if "Total" or "Combo" are selected, the total distance reported can be from the Catch Point or from the Offset to the Catch Point. The normal Stake Road command also offers "Progressive" and "Total" options for the story stake report. Store Grade ID Only avoids storing a Point ID with each point. If you click on "Show Report Up to CENTER", you only get the cutsheet report for the Slope Stake and Story Stake break points on the same side of the alignment of your measured point. If this is turned off, you get a full report on both sides of the alignment. The Slope Stake Report can also be stored in the ".not" file associated with the job. The prefix for Left and Right of centerline is defined at the bottom of the dialog. "R" for Right would save space versus "Right", which was used in the example cutsheet file above. Various uses of these settings are explored within the examples found in Stake Road in the Road Menu portion of the manual.

List Points

This command will list all of the points in the current coordinate (.crd) file. You can also edit any point in the list. If a Control File is active within Job Settings, Options, then you can also list and edit the Control File. The "FromList" icon also allows you to recall points from both the current Job and the Control File job, if active.

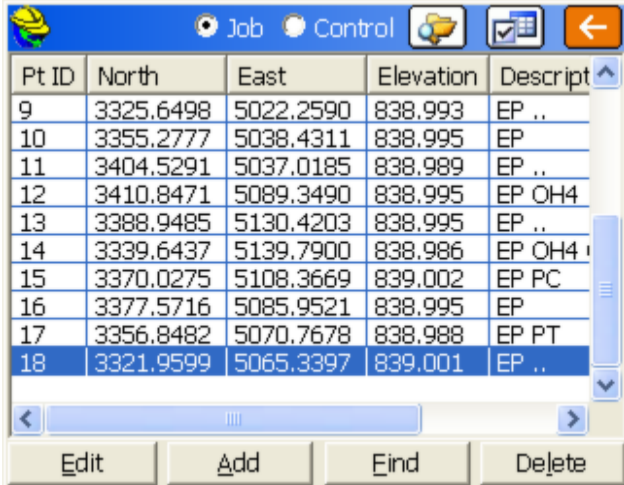

Pt ID	North	East	Elevation	Descript
9	3325.6498	5022.2590	838.993	EP ..
10	3355.2777	5038.4311	838.995	EP
11	3404.5291	5037.0185	838.989	EP ..
12	3410.8471	5089.3490	838.995	EP OH4
13	3388.9485	5130.4203	838.995	EP ..
14	3339.6437	5139.7900	838.986	EP OH4
15	3370.0275	5108.3669	839.002	EP PC
16	3377.5716	5085.9521	838.995	EP
17	3356.8482	5070.7678	838.988	EP PT
18	3321.9599	5065.3397	839.001	EP ..

The above figure shows the **List Points** dialog. The point list includes Point ID, Northing, Easting, Elevation, and Description. Columns can be shifted to condense the display, as desired. The new positions, however, are not stored.

-  **Details:** The type of file (alphanumeric or numeric point IDs), number of points, unused points and highest point number in the file appear in the **Details** option.

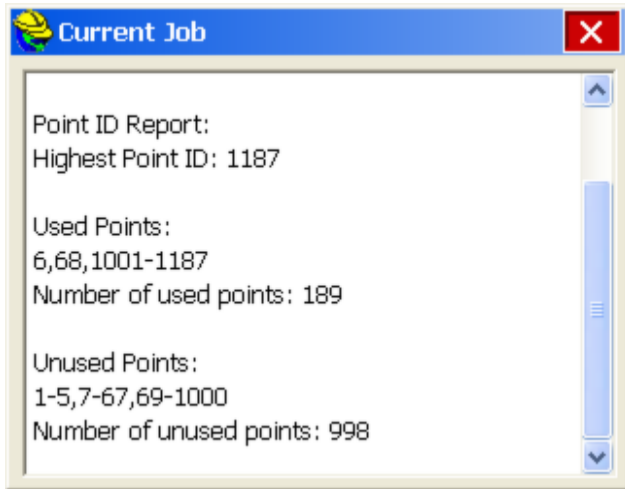

- 
Settings: Select the **Settings** button to customize the **List Points** display. The next figure shows the **Settings** dialog for List Points.

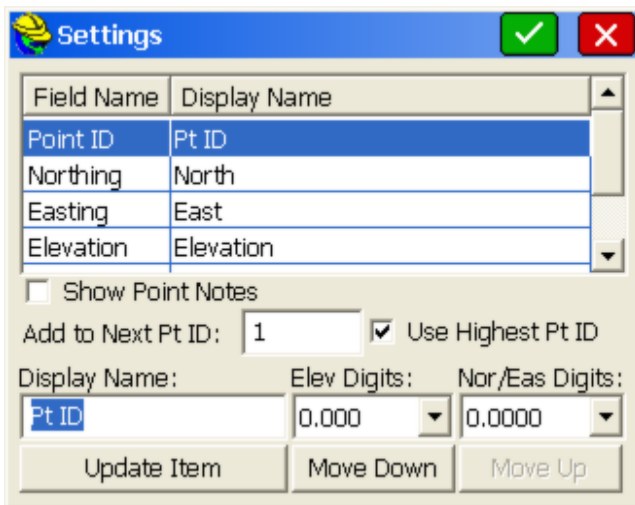

Show Point Notes: Notes can be placed in any order on the list, or can be disabled, as shown above. (Only notes entered in response to “Prompt for Point Notes” or “Edit Notes” within List Points itself will display. Notes for GPS accuracy, time stamps and cutsheets, for example, appear in the raw file but not within List Points.)

Add to Next Pt ID: This makes it possible to number sequentially using 1 or add 2 to every point to skip every other number.

Use Highest Pt ID: This defaults the next available point to the Highest Pt ID in the file after starting SurvCE.

Move Up/Down: To rearrange the order of the fields, highlight a field and use the **Move Down** and **Move Up** buttons.

Display Name: To rename a field, highlight it, enter a new name in the **Display Name** field and then tap **Update Item**. This feature allows customization so that, for instance, Northing and Easting could become X and Y as renamed.

Precision (Elevation Digits - North & East Digits): The decimal precision for each field can also be set in the **Options** dialog.

- **Edit:** To edit a point in the list, double tap on it or highlight the point and tap the Edit button. You may edit any aspect of the point. To edit, move the cursor into the field of the aspect to modify and enter the new value. Choose **OK** to enter the edited point into the coordinate file, or choose **Cancel** to negate your modifications. The Input/Edit Attributes button refers to GIS data attributes associated with a point. These GIS attributes will export in the form of shape files (Tools pull down in the Map screen). These attribute features help link SurvCE to the ESRI world, just as the DXF output of linework links to the CAD world.

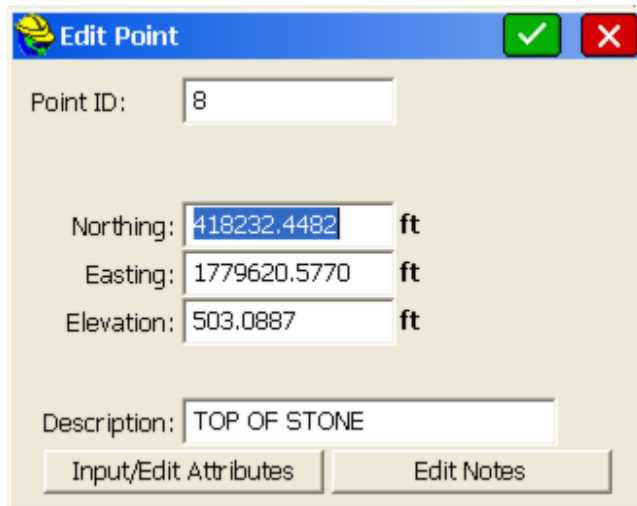

Note: If only the description value is edited, the raw data file will be updated without writing a store point record. If any other value that would change the point position is edited, the raw data file will record a store point record with the new position of the point.

- **Add:** To add a point, press the **Add** button. The **Add Point** dialog appears and you must enter the point ID, northing and easting. A store point record will be written to the raw data file.
- **Find:** To find a point ID, tap the **Find** button. You can search for a point by Point ID or description, but not both at the same time. When searching by description, any part of the description can be used to find the point and the search "gs*" has the same effect as "gs" to find points beginning with gs. Both would find the description "gs Sta 1+00 L25".

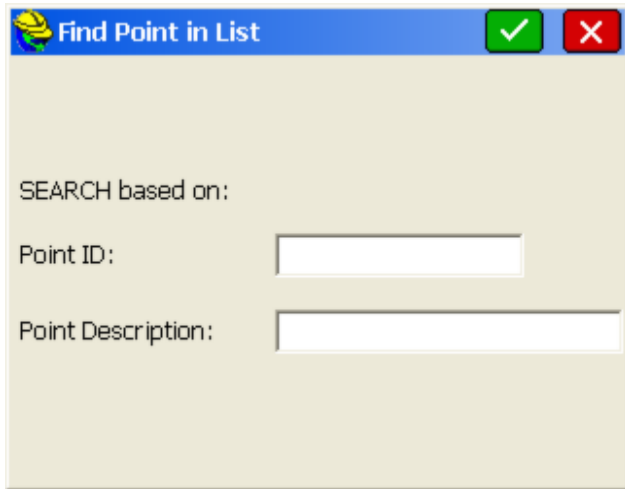

- **Delete:** To delete a point, highlight a point ID and tap the **Delete** button. You will be asked to confirm this choice before the point is actually deleted. To delete a range of points, use Keyboard Input within the Cogo Menu, option "Utilities".
- **Control File:** When a control file is specified, List Points offers the option to select the control file and to list the control file points. This feature enables the **From List** option found throughout SurvCE to access Control Points. The number of points and highest point number in the control file will now appear in the **Details** option.

Raw Data

Carlson SurvCE creates a raw file (.RW5) that contains various lines of survey data similar to a surveyors' field book. The data contained in the RW5 file will vary depending upon whether a total station, robotic total station, or GPS is used during the survey. The name of the RW5 file will default to the specified job name (*jobname.RW5*). This command enables viewing and editing of the raw survey data, as well as traverse closure and adjustment computations for the survey, for both total station and GPS raw data. If total station shots are involved, a graphical representation of the traverse can also be viewed using this command.

Total Station and GPS Use

Total station adjustments are conducted differently from GPS adjustments (**Process GPS**). If you wish to adjust your GPS first for control, and then calculate your total station traverse, first select **Process GPS**. Then use **Process No Adjust**, or **Compass**, as desired. If the rw5 file contains only total station data, Process GPS will be "ghosted" and will not function. If the rw5 contains only GPS data, then only Process GPS and Edit/Export RW5 options will be available. If both data types appear in the rw5 file, all options are available.

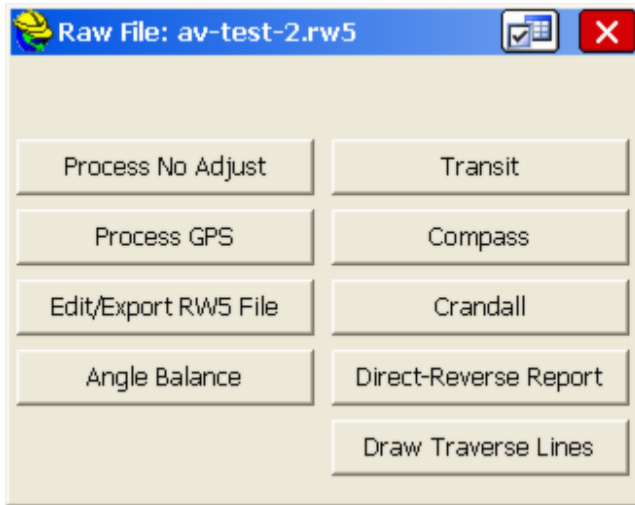

Process Raw File Operations: Total Station, GPS, Reporting, Editing

SurvCE has made available four different types of raw file processing. You can process or draw your total station measurements, report out the Direct-Reverse measurements, Process GPS, and Review and Edit the RW5 file.

Note that for all processing where new coordinates are calculated, beginning with SurvCE 2.0, upon exit the program will prompt you whether or not to store the newly calculated points into the coordinate file. This provides the flexibility to experiment with different processing settings and options without impacting the actual stored coordinates, until you deliberately choose to do so.

Total Station Adjustments

If you wish to adjust or draw a total station traverse, you would choose any of the following: **Process No Adjust**, **Angle Balance**, **Transit**, **Compass**, **Crandall** or **Draw Traverse Lines**. All of these commands have the same four-tab menu system, outlined below.

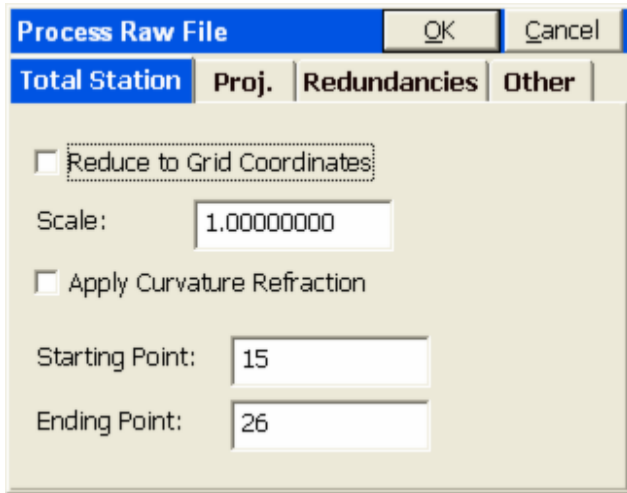

- **Total Station Tab:** Reduce to Grid Coordinates will perform a “ground to grid” calculation based on your GPS projection used, viewable in the projection tab. The Scale Factor for each leg of the traverse and for each sideshot will be independently calculated by averaging the combined grid/elevation scale factor for the start and end of the measurement. Apply Curvature and Refraction will compute curvature and refraction distinctly on all raw measurements and adjust accordingly.

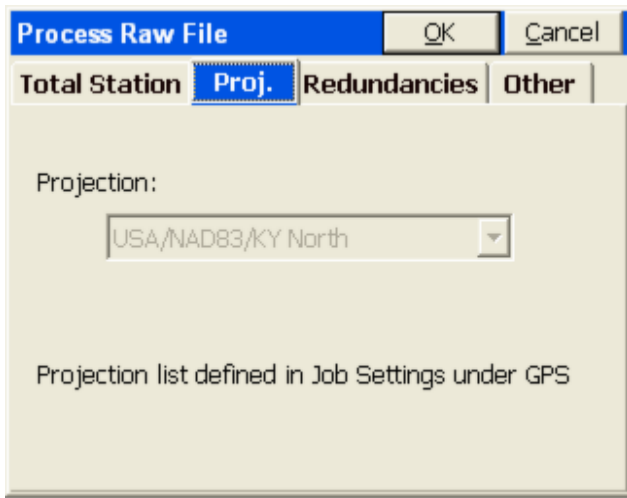

- **GPS Projection Tab:** This tab, critical for GPS calculation, only applies for total station work when **Reduce to Grid Coordinates** is set on within the Total Station Tab. To change the active projection, go to the GPS tab under Job Settings.

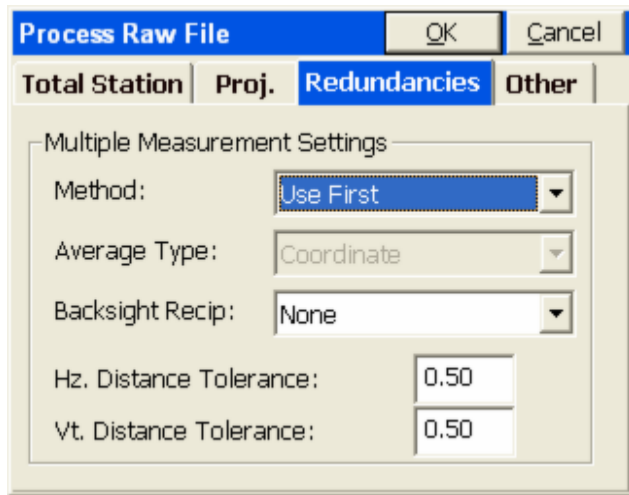

- Redundancies Tab:** This screen covers the handling of multiple measurements to the same point, known as redundancies. There are three options for **Method**: Use First, Use Last or Average. For example, if you shot point 10 a total of four times, you could choose to use the first reading, the last reading or average them all. If you select Average, then the **Average Type** option becomes available. Here you can choose from coordinate or distance measurement. If you shot point 10 four times, twice from two different setups, and then chose **coordinate** under the **Average Options** drop-down, then the 4 northings and eastings computed would be averaged. If you chose instead **Distance Measurement**, then the two measurements would first be averaged, and then the two distinct coordinates calculated for point 10 (using the averaged measurements) would themselves be averaged.

The **Backsight Reciprocal** option provides special treatment for reciprocals. A foresight to point 15 from a setup on 14, followed by a backsight from 15 to 14, makes a pair of “reciprocal” readings. The backsight reciprocal reading can be ignored (for its impact on recalculating the occupied point), or the Elevation component of the reciprocal measurements can be averaged, or both the Elevation and Distance can be averaged, to recalculate the setup (occupied point) coordinates. The program will calculate reciprocals for backsight direct (BD) records. First set Backsight Reciprocals to Average Elevation. Then if you foresight from 2 to 3, for example, then occupy 3 and backsight 2, the stored BD record will lead to an averaged delta Z calculation for point 3 within Process No Adjust or any of the other adjustment options. If the Tolerances entered above are exceeded, then warning screens appear during the processing.

Note: If there are significant redundancies in a traverse (reciprocal readings, D&R sets, multiple measurements to the same point from different setups, multiple tie shots into control) then it is recommended that the raw file be processed in a Network Least Squares program back at the office, such as SurvNet which is an add-on to Carlson Survey or

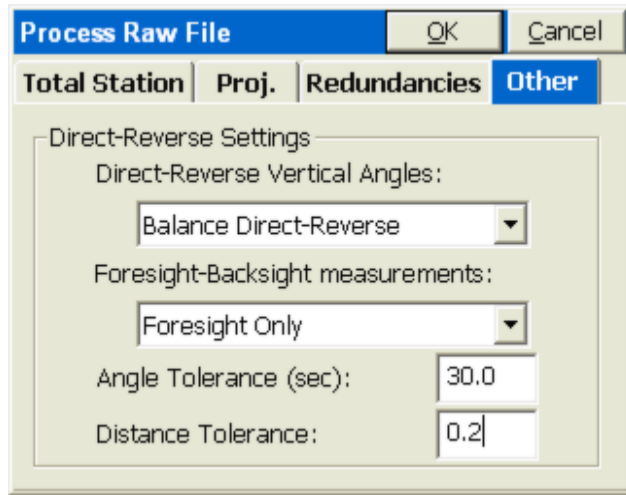

- Other Tab (for D&R Measurements):** This tab contains settings for how to use direct and reverse (D&R) measurements. For the vertical angles, you can balance the direct and reverse measurements or use **Direct-Only**. When you have Foresight measurements and Backsight measurements (e.g. slope distance/zenith angles) between the same points (e.g. reciprocals) in Direct and Reverse surveys, you can Balance Foresight-Backsight measurements (apply reciprocals) or use the Foresight data only. For purposes of warning screens, you can also set the Angle Tolerance and Distance Tolerance for Direct and Reverse measurement processing.

Process No Adjust

This command processes the RW5 file and computes coordinate values for the surveyed data. No angle balance or traverse adjustment is applied. The **Process Raw Data Options** dialog shown below appears after selecting Process No Adjust.

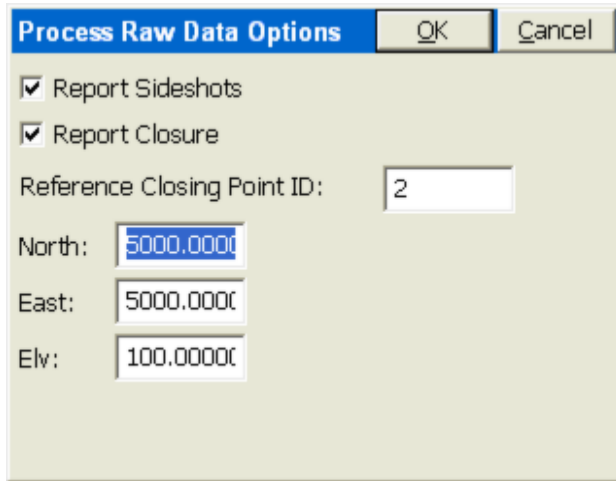

You can report the traverse only or compute all measurements by clicking on **Report Sideshots**. If you click on **Report Closure**, then you need to specify a **Reference Closing Point ID**, which is the point that the last traverse point is closing to, or trying to match. The **Reference Closing Point ID** is not a point in the traverse—it is the point the traverse is trying to close on. It can be entered as a point ID or a coordinate.

Note: To preserve coordinate values of the initial setup and backsight, particularly with D&R measurements involved, it is recommended that **Redundancies** be set to **Average by Distance Measurement**, if averaging is used.

Pressing OK leads to the calculation and the report screen for Process No Adjust.

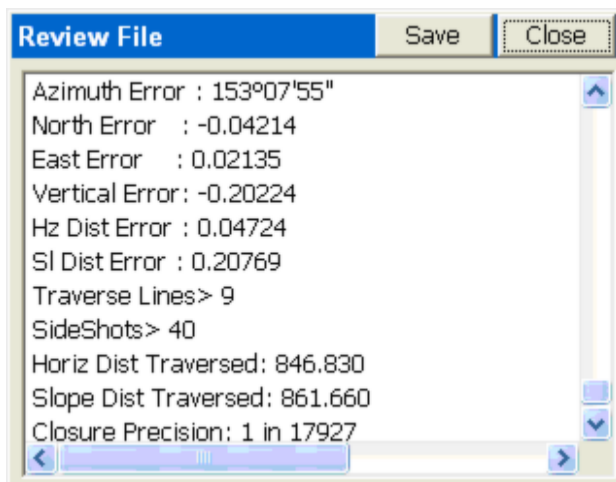

Angle Balance

This method of processing applies an angle balance to the traverse lines when

calculating the coordinates. The angle balance takes the angular error divided by the number of traverse lines and adjusts the angle of each traverse line by the calculated amount. The angular error is the difference between the angle balance shot and a reference angle. The program will prompt you to enter the traverse shot to use as the angle balance shot. The measured direction between the occupied point and the foresight point in the specified angle balance shot is then compared to a reference angle. The reference angle is specified as a bearing, azimuth or by a traverse line defined by entering a **From Point** and a **To Point**. The angle balance process is initiated by selecting the angle balance option from the process raw file menu.

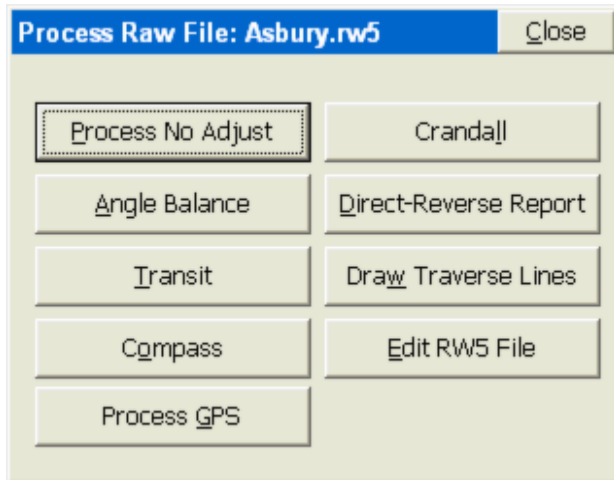

The Angle Balance Measurement dialog appears in the figure. Suppose a given traverse started at 24, traversed up to 25, then around a loop and back to 24 (point 45). If point 45 was the end point or closing shot, the traverse leg from 45 to 46 could be the angle balance shot. It is very common, for example, in closed-loop traversing to take a closing angle shot from the closing point (45) by measuring the angle along the first traverse leg (24 to 25). That is what occurred in the case of this sample traverse.

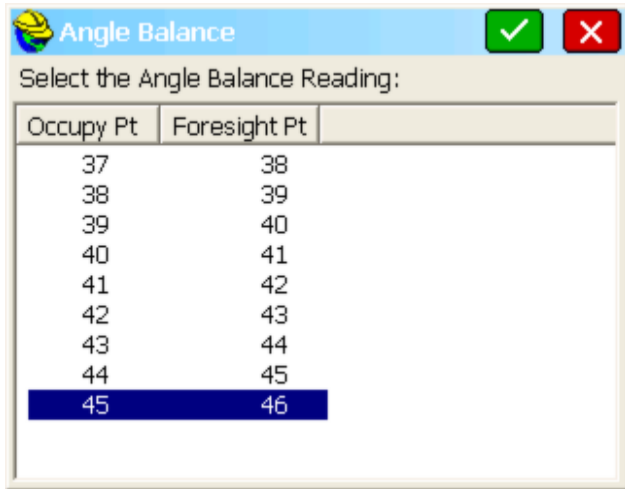

Next, the **Reference Closing Angle** dialog appears. Enter the bearing or azimuth of the reference angle, or define the reference angle with points by entering in the desired point numbers in the **From Point** and **To Point** fields. If using bearing or azimuth, enter the bearing in DD.MMSS format and then select the correct quadrant from the format field located at the bottom of the dialog. Once the reference angle has been defined, then the angular error display will update with the calculated angular error. The measured closing bearing and measured closing azimuth is displayed at the top of the dialog box. If the reference angle has been defined by point numbers, then the reference closing angle field will update and display the defined angle. There is no need to select a format from the format field if point numbers are used.

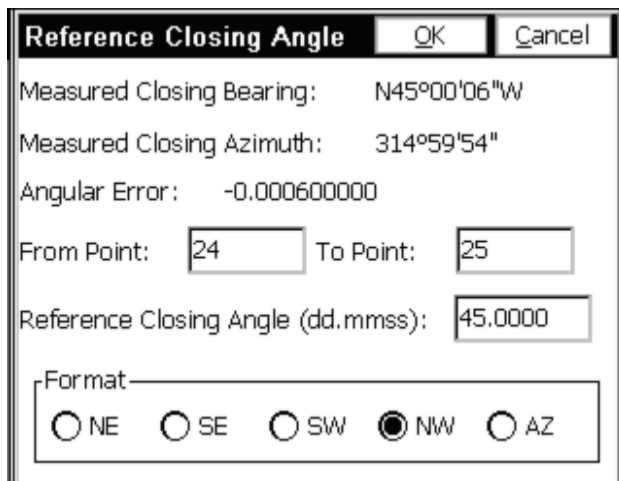

Pressing the **OK** button, or the enter key, will execute the angle balance process, and the process results will be displayed. The results display shows the closure

results before angle balance and after angle balance.

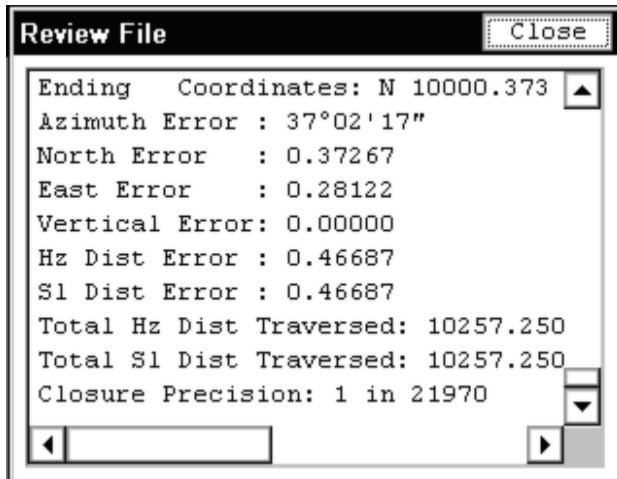
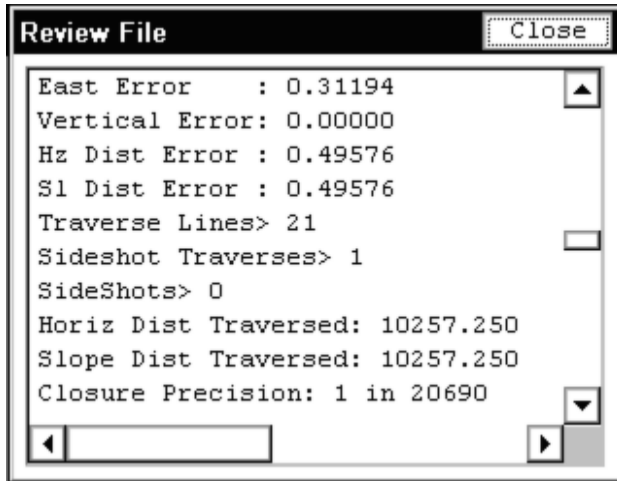

The angular adjustment applied to each traverse leg is also displayed, along with unadjusted angles and adjusted angles for each traverse leg. The adjusted coordinates are written to the coordinate file replacing the unadjusted coordinate values.

Transit, Compass, Crandall Adjustments

These methods apply the selected rule to the traverse lines when calculating the coordinates. After adjusting the traverse points, the sideshots can also be recalculated. The closure error is calculated as the difference between the specified ending point and a reference point. The ending point is specified in the initial dialog.

You can change the ending point to correspond to the point in the traverse that closes back to the existing reference point. In the current example, point 26 is the final shot, and is closing to an existing point, 10.

The reference point is specified by point ID or by entering the northing, easting and elevation of the reference point.

The process results show varying information depending on selected options from the **Process Raw Data Options** dialog box.

- **Reference Closing Point ID:** The desired closing point number must be entered into this field. If the closing point does not exist in the coordinate file, the known coordinates can be entered into the North, East and Elevation fields on the dialog box.
- **Apply Angle Balance:** This option performs an angle balance on the

traverse lines before the selected adjustment routine is processed. With this option enabled, the Angle Balance Shot must be chosen from the Angle Balance Measurement Dialog box. The adjustment method is applied without angle balance computations.

- **Vertical Error Adjustment:** The vertical error between the starting and ending points will be calculated and displayed in the results screen. An adjustment value is determined and applied to the traverse points proportional to their measured distance.
- **Report Point Adjustment:** The adjusted point coordinates and the original point coordinates will be displayed in the results display under the adjusted point comparison section.
- **Report Unadjusted Points:** Displays points not impacted by the adjustment routines.

Draw Traverse Lines

This button will process total station data and show the traverse and sideshots graphically. The example below shows 2 traverse legs and a total of 6 sideshots.

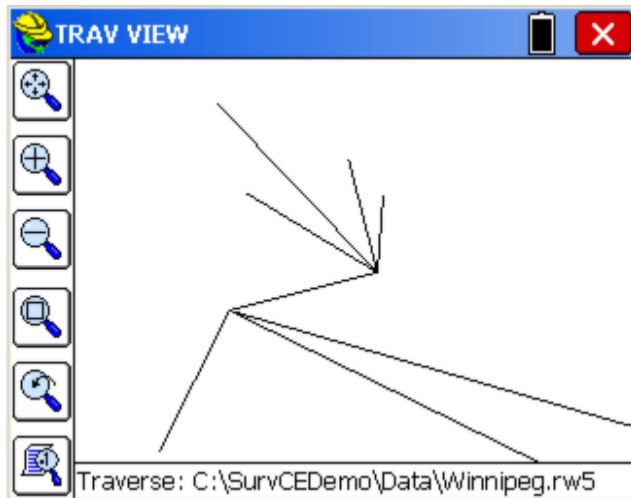

Process GPS

This option is available when GPS data is detected. The opening screen appears below:

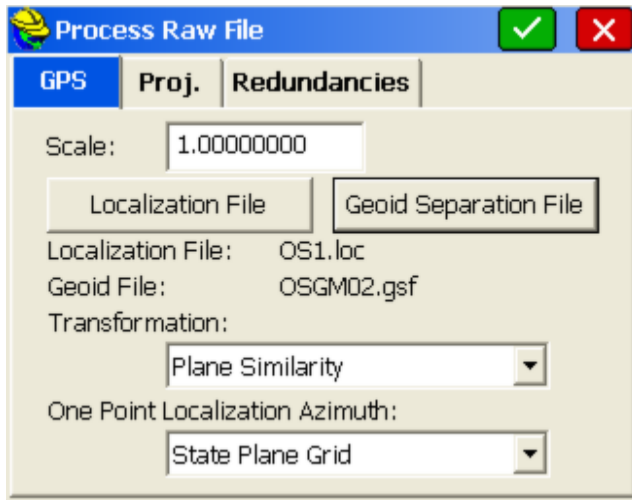

If a virtual reference station is used, then the Projection tab will govern and there will be no Localization File, which typically applies to a base-rover setup with UHF radio communication. Clicking the Projection Tab reveals the active projection. Similar to total station adjustment, the Redundancies tab allows selection of the First measurement, Last Measurement or Average of all measurements when duplicate ID measurements are detected. A set of GPS (Lat/Long) measurements can be re-calculated based on new, distinct localization files. For example, if your very last measurement was a control point, you could add that to your localization file (Equip, Localization) and then go to Process GPS to recalculate all GPS measurement taken that day.

Feature Code List

This command allows you to define default, ready-to-use descriptions. These descriptions lead to linework drawn within SurvCE as well as point symbols. It is important to point out that the drawing of linework and point symbols must be "activated" within Job Settings, Options, by clicking on "Use Code Table for Descriptions". If this is clicked off, linework and symbols will not be drawn. SurvCE ships with "Use Code Table" on. In addition, within Configure, the option "Show Line Details" will automatically redraw the linework whenever any revision occurs or whenever the Map screen is selected. So if you had a line drawn from points 101 to 105, but then you edited or resurveyed point 102, "Show Line Details" will lead to the automatic redrawing of the line whenever the graphics are shown. If this is clicked off, then you would need to go to the Map screen and select Tools, Field-to-Finish, to update linework.

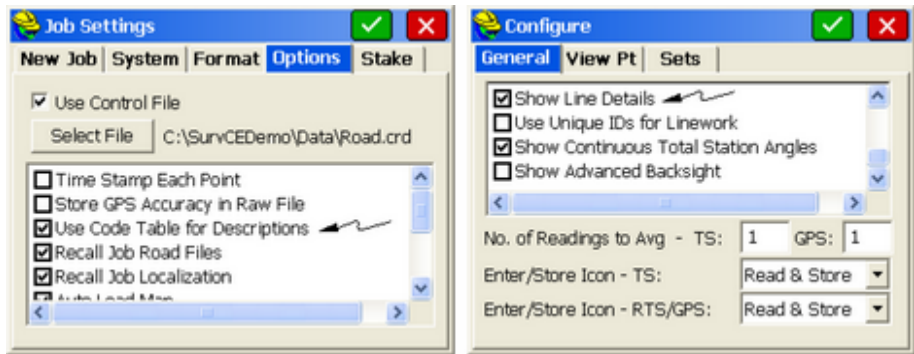

Both lines and points can have attributes describing aspects such as material type, quality, age and date installed. You can create multiple feature code lists and each list can contain an unlimited number of codes. Each feature code consists of a short code, a longer description, a polyline toggle, and a polyline type setting. Point-type features can have symbols. All features can have associated prompting for GIS attributes. Feature codes can be organized into categories, which is useful to sort through large code tables using shorter lists picked by category. The initial dialog is shown below.

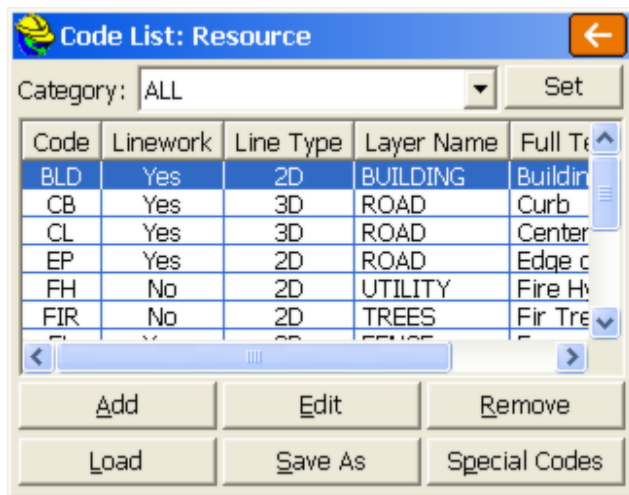

Add a Feature Code Category

- Set Button:** You can add a new category and then within Add or Edit Code, assign each code to a category. Clicking "Set" takes you to the Category Manager. Enter New Categories beside "New Name" and click New. This adds to the Category List within View Category. Then when selecting "All" categories, you can select one or more codes and assign them to the category selected at the bottom of the dialog, by clicking "Move To".

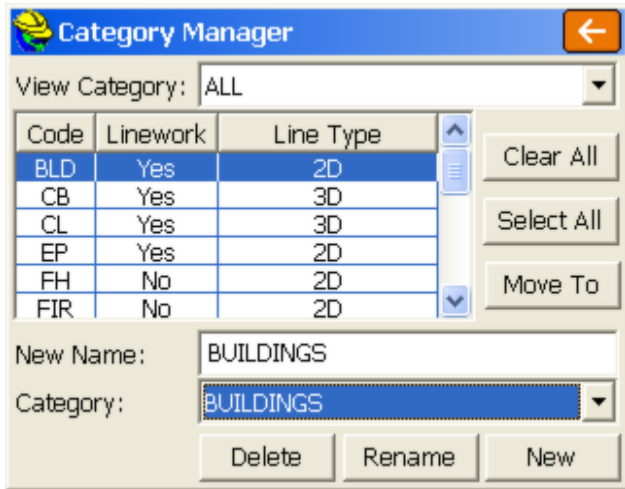

Add a Feature Code

- **Add:** To add a code to the list, select this button. The **Add Code** dialog will appear.

Select a Feature Code File

- **Load:** The **Load** button allows you to select a file to open or edit. Choose an existing file or enter a new file name to create a new Feature Code List. Feature Code List files have a *.FCL file extension.

Edit an Existing Code

- **Edit:** If you wish to edit an existing code, double tap on the code or highlight it and tap **Edit**. It will appear in the **Edit Code** dialog.

Saving the Feature Code List

- **Save As:** Select the **Save As** button to save the file. Choose an existing file or enter a new file name to create a new feature code list.

Remove an Existing Code

- **Remove:** To remove a code from the list, highlight an existing code and press the **Remove** button. SurvCE will ask you to confirm deletion of the code.

The **Add Code** dialog is shown below. Below the figure is a description list of the various options and buttons available in the dialog.

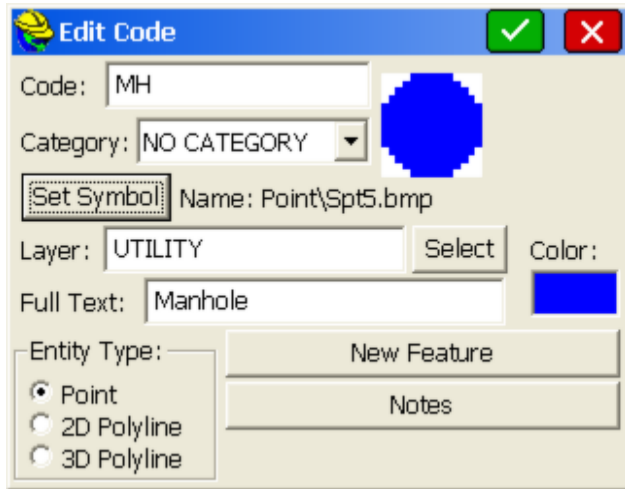

Code: Enter the name of the Feature Code. For example, you might use EP for edge of pavement.

Category: If categories have been established (set) within the main Feature Code List screen, then individual codes can be assigned to a category. The very appearance of categories can be removed by clicking off the "Use Categories" option within Special Codes, Settings. This creates more space for the list of codes if there is no intention to use categories.

Set Symbol: For Point entity types, symbols can be assigned, as an option. Symbols plot on the screen for quick reference and will export by .Dwg or DXF using the Map Screen, provided "Include Symbols" is clicked on. Symbols are stored as bitmaps or ".bmp" files, along with ".dxf" files, on subdirectories of the "SurvStar\Symbols" directory created by the install of SurvCE and SurvPC. Three subdirectory "libraries" are typically provided: "Point", "Inlet" and "Trees" as shown below:

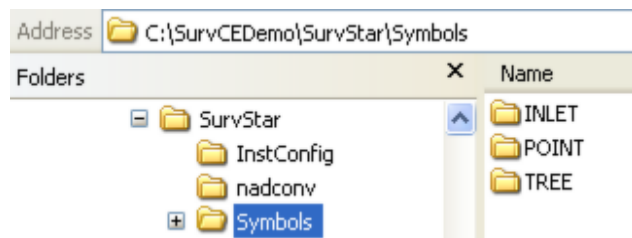

Within SurvCE, you can load the any symbol from any selected library by clicking the library, such as "Point" and selecting the symbol to use for the feature code.

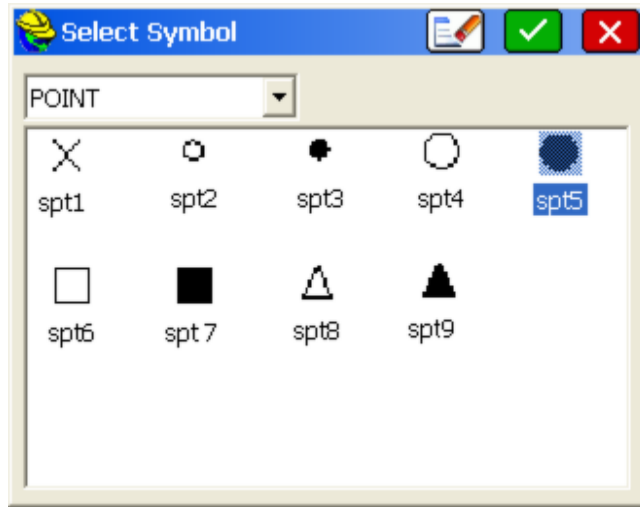

You can create your own symbol library, such as "DDC" shown below, by first creating the additional subdirectory within "Symbols" on your data collector, then adding to that subdirectory both a unit-sized symbol and bitmap for display and viewing, for each symbol. If the "DDC" subdirectory is selected, for example, an additional manhole symbol could be added as shown below:

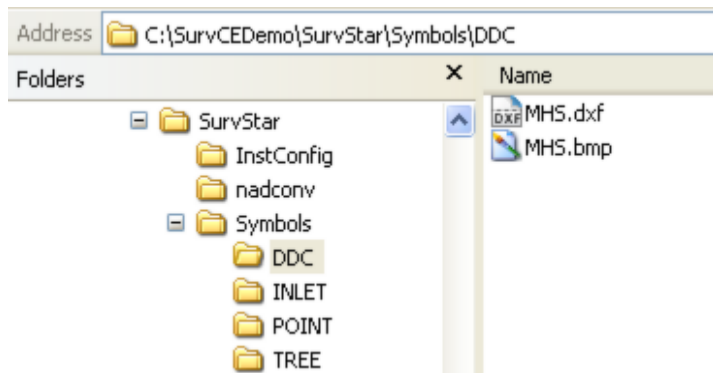

The bitmap for this "MHS" symbol appears as shown here: 

If MHS is entered as a new feature code, this symbol can be selected as follows:

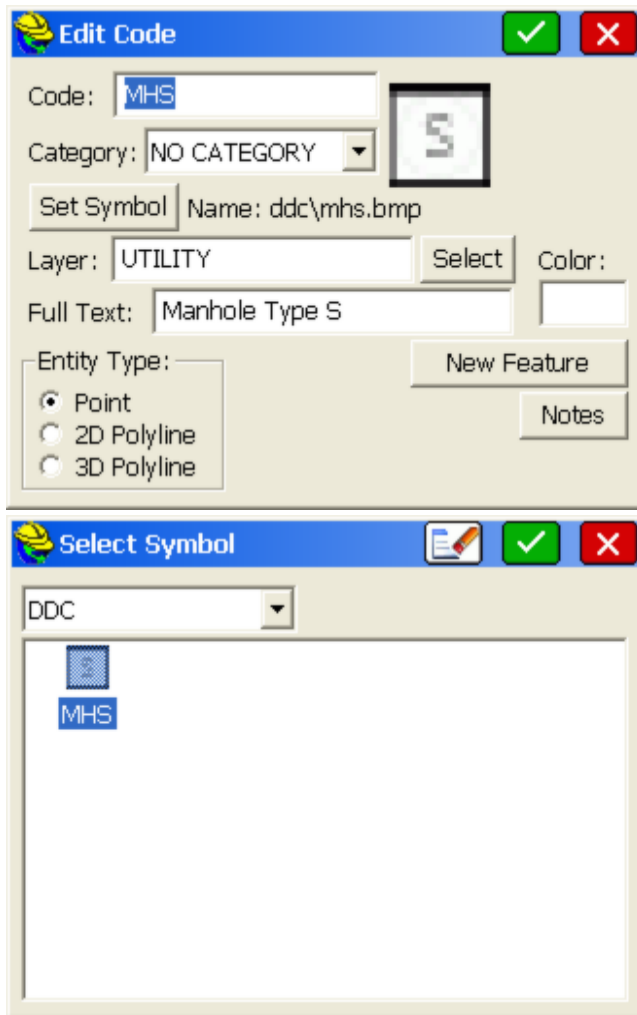

Then when locating MHS features in the field using the command Store Points, the newly defined symbol will plot, as shown below:

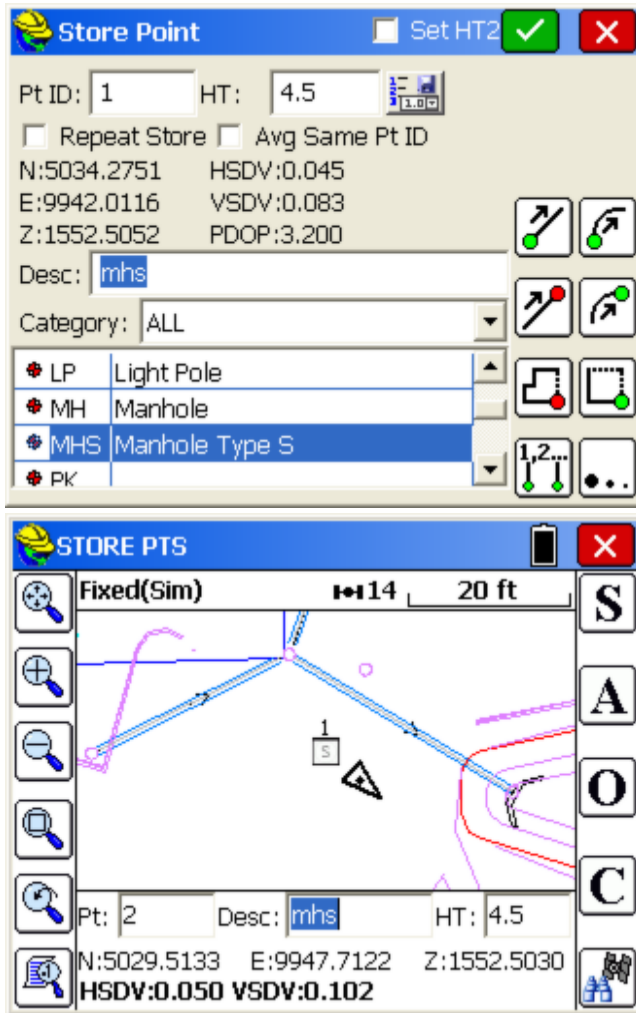

Layer: Symbols and linework can be assigned to layers, and will export to DXF or .Dwg files in the assigned layer. Even if office software is used to conduct field-to-finish, layers and distinct colors are useful for viewing points and linework while in the field.

Color: The color of the layer will be applied to the symbol or line. But if you click on the Color box, you can assign a different color than the one associated with the layer.

Full Text: Enter a description for the code. This is only for your information. It will not be added to the point description. It is particularly helpful when using numeric codes, to remind you of what they refer to.

Entity Type: There are 3 entity types: point, 2D polyline and 3D polyline.

Polyline 2D vs 3D: Choose whether the polyline should be 3D or 2D. If you choose **3D**, then each polyline vertex is located at the elevation of

the point. If you choose **2D**, then the entire polyline is constructed on elevation 0, regardless of each point's elevation. If **2D** is selected, you can change the width of the polyline (in inches or centimeters if metric), as shown below. Selecting "Custom" allows entry of a user-defined width. An example of use might be a painted "stop line" at a road intersection.

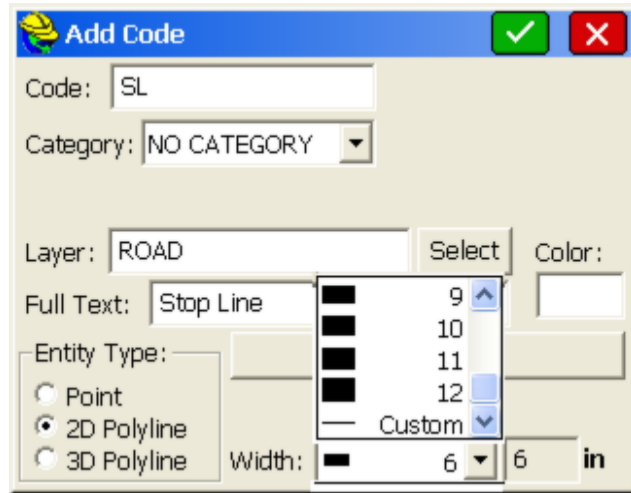

Notes: Allows the association of a user-entered Note with any feature code. Since notes have no character limit, large descriptions can be entered as notes and applied to each instance of the feature code, avoiding the need to enter or select the note in the field. Also, for options like "TR" for Tree, you can preset Notes such as the type of tree (oak, maple, etc.) and choose from a list of notes. "Prompt for Point Notes" should be turned on within Configure to access the Notes option. If Settings within "Special Codes" is selected, you can limit the list of notes to choose from, to just the list associated with the Feature Code, by clicking on "Use Code Notes Only When Storing Point".

New Feature (GIS Attributes): This option leads to GIS type attributing, where you can further describe the code (e.g. MH for Manhole) with additional attributes. If GIS attributes are entered for a code, then the "New Feature" button becomes "Edit Feature". SurvCE allows use of the identical, "preferred" names for features as outlined in the ESRI Geodatabase Schema enabling direct uploading in ESRI products and Carlson office products, where the data is auto-linked to screen elements. The link to ESRI and the Carlson GIS office products is accomplished through the Shape File Export command in the Map screen. Then use Import Shapefiles in ESRI or Carlson GIS or other GIS products. An alternative is to save what is known as the MSC extension data into the .Dwg file within SurvCE, and then export to .DWG within the Map Screen. This imports seamlessly into ESRI products.

For example, consider a manhole survey where 4 distinct attributes are to be entered for each manhole surveyed: Lid Diameter, Wall Material, Depth to Flow Line, Number of Inlets. The setup process begins by clicking on "New Feature". If you click "Set", you see that the "Feature Class Name" for the code defaults to the code name "MH". The Feature Class is a GIS term which assists in the database linkages within GIS software such as ESRI and Carlson GIS. A typical "Feature Class" as named by the "Set" option, might be SWManhole representing "Storm Sewer Manhole". Do not use a colon (:), semicolon (;) or forward slash (/) in the Feature Class name. Clicking Set establishes the Feature Class, and the same Feature Class name can be assigned to different codes. For example, Pine, Spruce and Deciduous trees can all be placed in Feature Class "Trees". In this case, you would enter SWManhole and click OK.

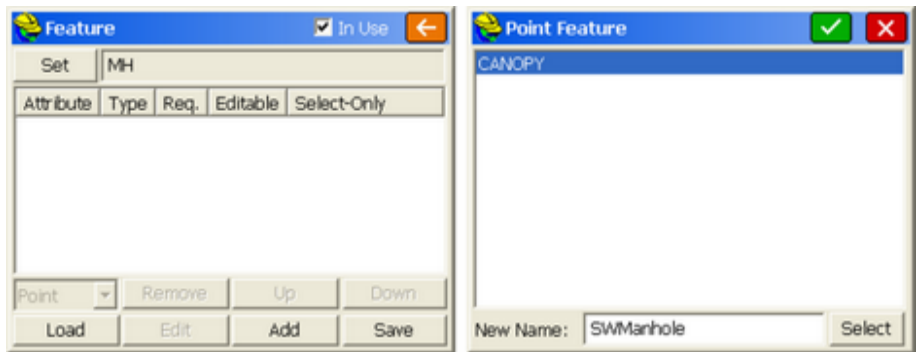

Then for this new Feature Class (SWManhole), you can enter the 4 attributes. The result is shown below at left, with a typical attribute entry (use Add to create new entry) shown at below right. If you click "Add" in the "New Attribute" screen (below right), you can create a list of values to select from while in the field. For an attribute such as depth (to flow line), a real number entry can be specified (as opposed to a character entry involving letters), and no default values would be entered since depths are variable. If you click "Use List Only", then you are restricted from entering an attribute in the field except what is in the list. If you click off "In Use" at the top of the Feature dialog, then you will not be prompted for attributes for this code when working in the field.

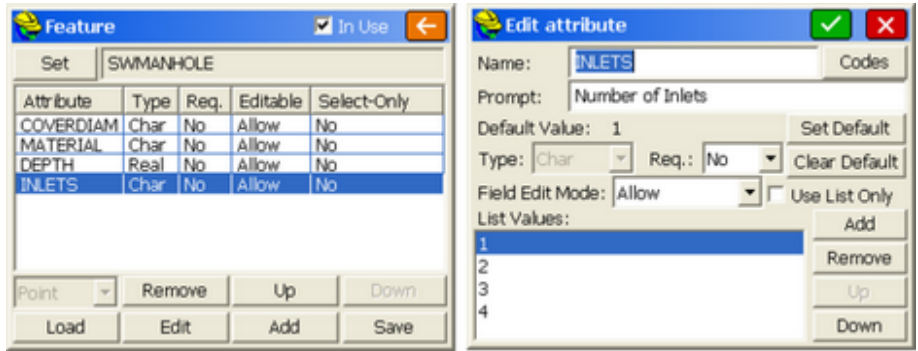

When "MH" is coded in the field, the attribute options would then appear. If there are more than 3 options (as above), the Next and Previous buttons become active:

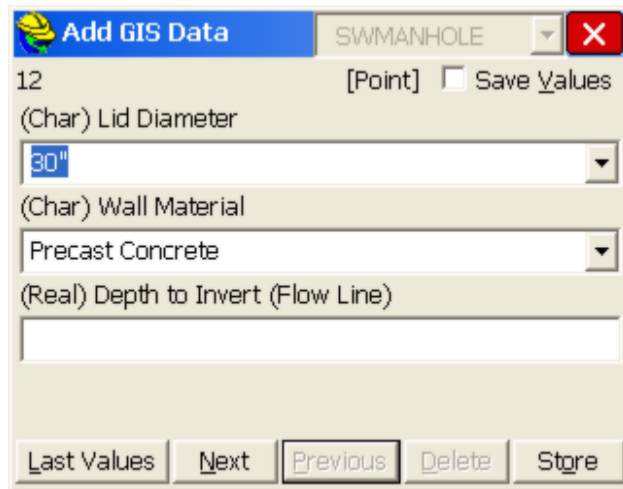

The same system applies to linework. For the fence line code "FL", an attribute called Fence Type might be used, and there may be 6 options, with a default option. These can be set up, one time, by using the **Add** option within New Attributes. Once setup, whenever a fence is chosen, the attributes can be selected from a list. These attributes will be stored in the raw file and most importantly, will output to an ESRI Shape file (Map Screen, File pull down, Export SHP File). You can even control the prompt and what the default attribute is (in this example, "Chain Link") and if you wanted Chain Link to be first in the list, you could highlight it and click "Up". You can choose whether each attribute entry is required, or just optional. In "Field Edit Mode", the "Hidden" option lets you hide individual attributes on specific jobs so that prompted options are limited to only what you need. The "Read-Only" option ghosts the attribute and does not allow entry or editing, but still displays it in the field and specifically stores the default value shown. The setup screen for new attributes is shown below.

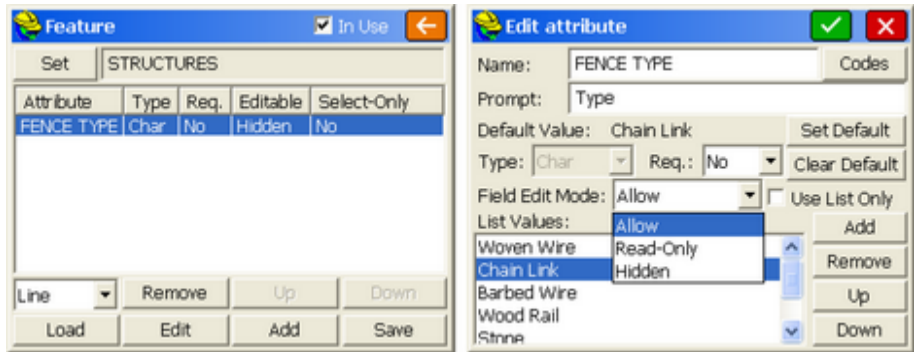

Fence type is a user-defined attribute. But many attributes of the feature are known by Carlson SurvCE (e.g. the current instrument being used, the date and time, etc.). These types of known attributes appear in a list of special codes, selectable above by tapping "Codes", and shown in the figure below.

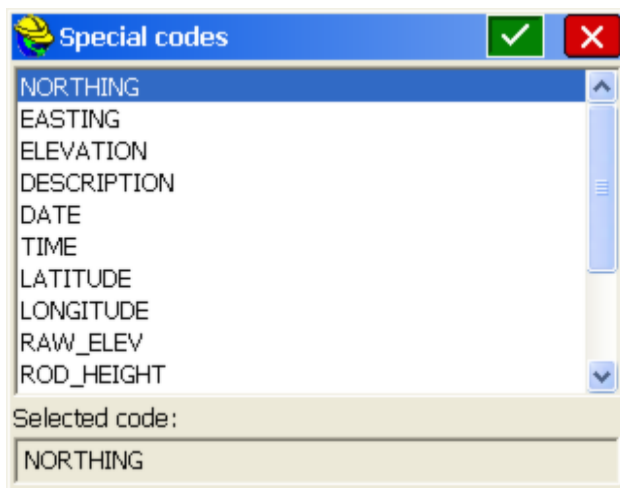

When you are collecting the points with an “FL” code, and the program detects that you have shot a “point-only” feature, or if you are shooting a line, that you have ended the line (e.g. FL END), then you will be prompted for the attributes. If, however, you select the Point option (lower left) for codes that involve linework, you will get prompted for attributes at each vertex, and then once for the line as a whole. In this way, you can be prompted for attributes of each pole on a power line, and then once for the entire power line (separate set of attributes).

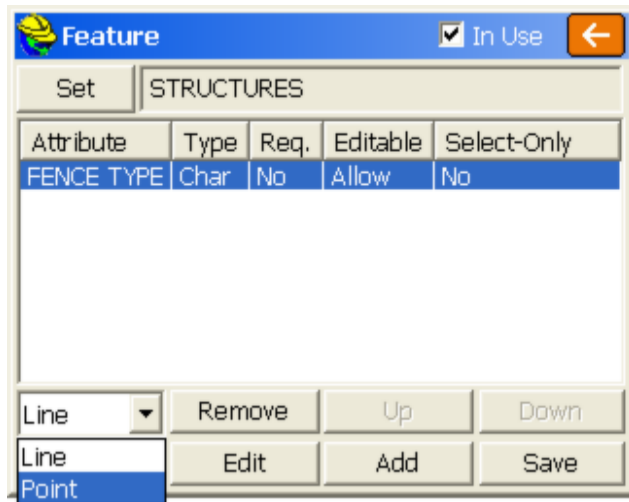

Note in the dialog below, you can set when you are prompted for the line attributes (start vs end of line). This screen is found within Special Codes, Settings (button at top of screen in Special Codes). The "Use FCL Path to Store *.GIS" means that the folder used for the Feature Code File will also be the folder used for the *.GIS files that are made for each description with attributes. (This applies only to pre-SurvCE 2.51 versions). For example, if MH has attributes, a file MH.GIS will be created. If FH has attributes, a file FH.GIS will be created. These *.GIS files normally store in the current job data directory, in a subdirectory called \CSGIS\FCLFileName (name of the feature code list file). Beginning in SurvCE 2.51, only one GIS file is made, and it always goes in the standard data subdirectory that contains the FCL file. Even this single file protocol is an option in SurvCE 2.51 or later, set by clicking on "Use Single Carlson GIS Features File" at the bottom of Settings within Special Codes. SurvCE 2.51 or later is backward compatible for use with earlier FCL files, and will continue to use the coding system for attributes for FCL files set up by earlier versions, including file location protocols. The GIS file location protocol is shown below, based on a data folder called c:\data and an FCL file name called FieldCodes.fcl:

Prior to SurvCE 2.51

C:\Data\CSGIS\FieldCodes\MH.GIS
 C:\Data\CSGIS\FieldCodes\FL.GIS, etc.

SurvCE 2.51 and After ("Use Single Carlson GIS Feature File" clicked on)

C:\Data\FieldCodes.GIS

SurvCE also creates an *.VTT file which contains the actual user-entered attributes. This file is associated with the CRD file. The combination of the CRD and VTT files are used to export the shapefiles under the Map Screen, Fill pulldown. If you wish to store the same attribute data on all vertices on a line, you can click on "Store GIS Line Data to All Vertices", as shown below.

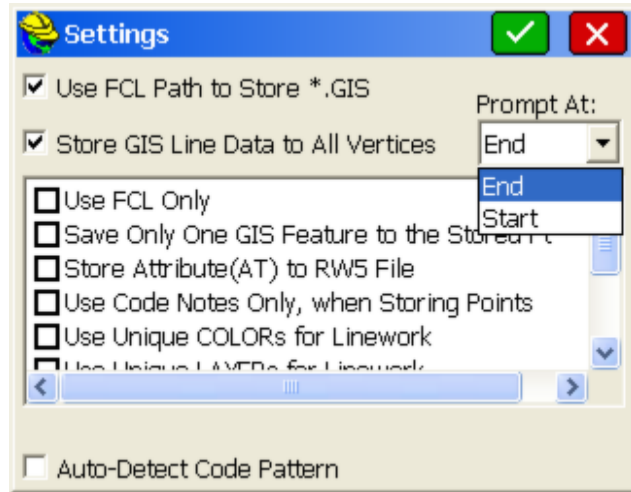

The "Save Only One GIS Feature to the Stored Pt" is a rarely used item which applies to field measurements with 2 or more codes (eg. MH FH) where MH for Manhole and FH for Fire Hydrant both have GIS prompting associated with them. With this "Store Only One" clicked on, you would be prompted in the field for which item (MH or FH) to assign GIS coding to, and only one set of attributes are associated with the single point surveyed. If "Store Attribute(AT) to RW5 File" is on, then the attribute data also stores to the raw file, and can be viewed using FILE Raw Data Edit RW5 File.

Special Code Suffixes

- Special Codes:** In addition to the codes that you add to the Feature Code List, there are some predefined code suffixes that you may use to end lines or start curves. For example, FL END could end the fence line, with "END" being a predefined special code. The need to append codes is one reason that the "END" button on your data collector is useful, to move to the END of the existing description so you can append a special code. You can substitute new codes for default codes, such that "." can be substituted for "END" to end a line. To substitute a code, highlight it and enter the substitution characters at the bottom of the screen, in the "Code" entry box. The special code suffixes can also be entered as prefixes, as in PC EP (for start curve) rather than EP PC. Special Codes should be separated from your actual feature codes by a space. However, the alias of "." can go right up against the feature code as in "FL.". The special codes are described below.

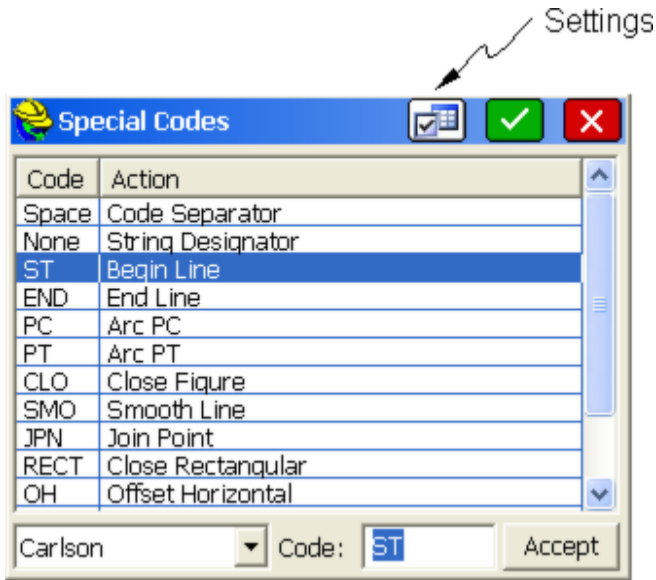

ST & END: Start and End Line. Some users prefer codes such as BL for Begin Line and EL for End Line, and ".." is another example of an "end line" code. You only need either to start or end lines to get new lines. You don't need to use both the start and end line coding. If you code 3 EP points as EP ST, EP, EP then the next new line can be EP ST again. Or you could just end the line as in EP, EP, EP END, then start again with EP. Another separate technique to generate unique lines is to add a number to the code, as in EP1, EP1, EP1. Then if you code EP2, EP2, EP2 a separate line will be drawn. In this case, you don't even need to use the start or end special codes. This allows you to mix the codes up as in EP1, EP2, EP2, EP1. In this case, the EP1 codes will connect and the EP2 codes will connect. See also the discussion below on "Auto-Detect Code Pattern" for techniques of cross-sectioning roads and other linear features. Within Configure, the option "Use Unique IDs for Linework" makes use of the EP1, EP2, EP3 concept by incrementing the appended number each time a new line is started using the line start code (eg. ST) or the line start icon. With "Use Unique" on, the EP code becomes EP1 when you start a line, and if you use EP again and start another line, the code becomes EP2, etc. In this case, the ST code is retained (redundant but harmless) as in EP2 ST, EP2, EP2.

PC & PT: Used to specify the point of curvature (PC) and point of tangency (PT) of a curve. If you are taking shots on a curve, use PC to specify the beginning of the curve and PT to specify the end of the curve. The PC special code will activate a 3-point arc automatically, so use of the PT code in a 3-point arc is redundant and therefore it is not necessary. You can even do a reverse curve by entering the PT instead as PC. However, if you are picking up a meandering stream or tree line, PT is useful to end the curving feature, and the program will "best fit" a curve through all the surveyed points between the PC and PT codes.

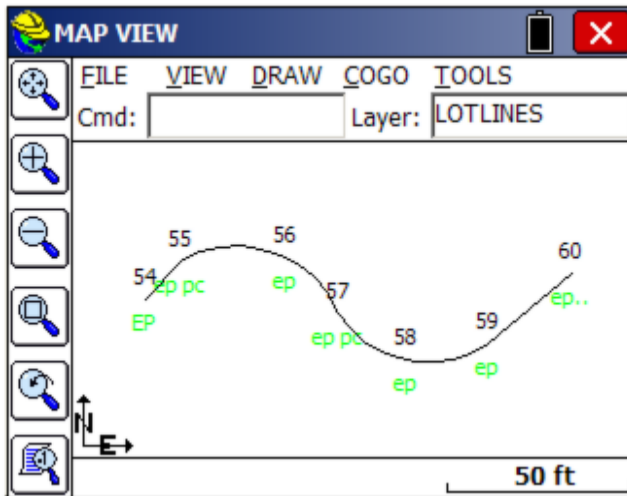

CLO: Use this code to close a figure. This tells the software to close from the last point coded as CLO back to the first point of the figure. Note that after using a special code such as "CLO", appended with a space to the description code "BLD", that the program automatically removes the special code as it defaults the next description to "BLD". The "CLO" code also has the effect of ending the line and starting a new line. It only works with codes defined as 2D or 3D polylines.

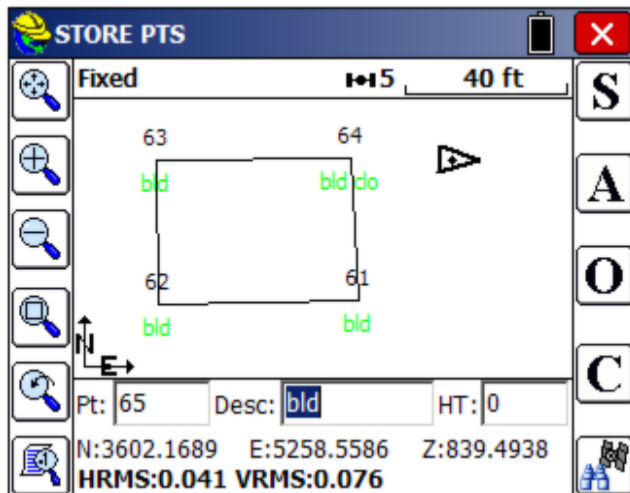

SMO: Use this code to smooth the line through all of the points. This code must occur on the first point of the line.

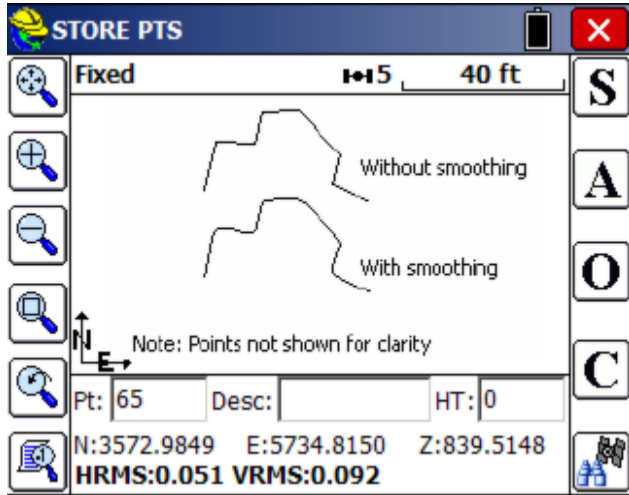

JPN: Use this code followed by a point ID to create a new line segment between the current point and the entered point ID.

RECT: This special code can be used in 2 different ways. You can take measurements to 3 sides of a building and on the third side, add the special code RECT, and the program will create a 4-sided building. Or you can measure two sides of a building and enter the distance right (RECT25) or distance left (RECT-20) to create the other, parallel sides. Both methods are illustrated below.

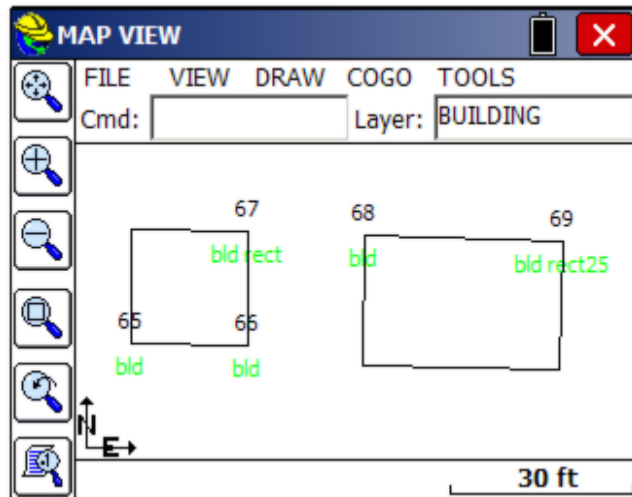

OH and OV: You can also create horizontal offset lines and you can offset these same lines vertically as well by combining OH and OV as in EP OH0.5 OV0.5 (which might create a 6" over, 6" up back of curb parallel 3D polyline). You can even do multiple offset lines as shown below:

	Elevation	Description	Pt ID
.27	109.629	tr oh-5 oh-12.5 oh-17.5	120
.97	109.673	tr	121
.12	109.733	tr	122
.92	109.808	tr	123
.96	109.819	tr	124
.29	109.837	tr	125
.08	109.780	tr..	126
.18	103.966	tw	127
.89	104.159	tw	128

This example here leads to a series of 4 parallel lines (for railroad tracks in this case), all offset to the left (negative) of the direction of the points 120 through 126.

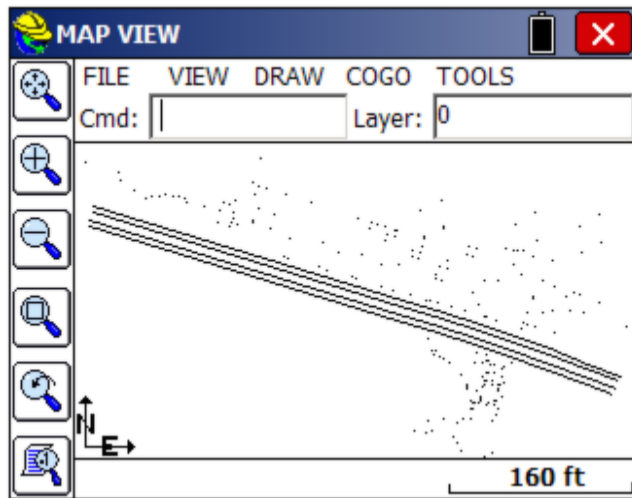

The OH and companion OV commands are flexible in that they can be entered after the first point measured, such as on point 121 or 122.

NE: No Elevation. When a point is coded NE, it will not be used inside SurvCE for contouring or use in volumes. However, if a 3D Polyline is drawn connecting between points, the elevation will be used.

JOG: This powerful option allows you to hand-enter right-angle extensions of the last line segment. So if you have just measured 2 BLD points from 14 to 15, you can enter 15 as BLD JOG 12 20 -5 10 17.

Minus means left. This represents R12, R20, L-5, R10, R17. The effect is shown below:

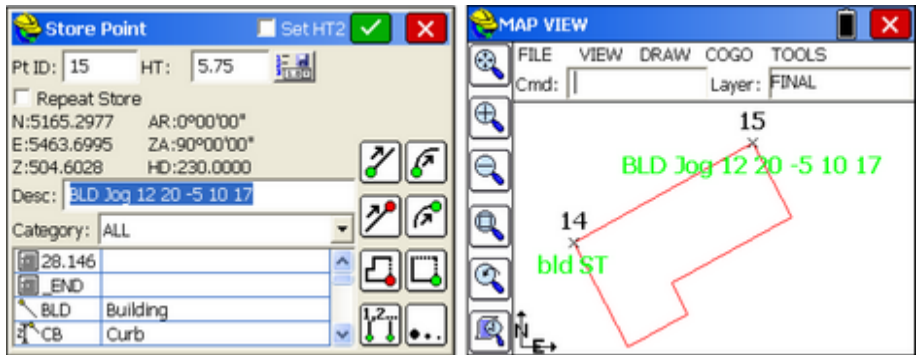

ZO: Elevation Only. This is just a way of coding points as being important only for elevation, for processing typically in other software. It can be viewed as reference information on the point--only the elevation matters.

AFIT: This code stands for "Arc Fit". It is used with 3-point arcs to avoid bulges caused by not picking the PC (start) and PT (end) of a true tangent curve accurately, in the field. When measuring curbs, it is common to get a bulging curve as shown below by picking point 9 too soon, still within the tangent, straight portion of the curb. Note that the EP2 PT description on point 11 is not necessary--the "PT" portion is assumed on a 3-point arc. Only the "PC" code on point 9 is necessary to initiate and draw this arc.

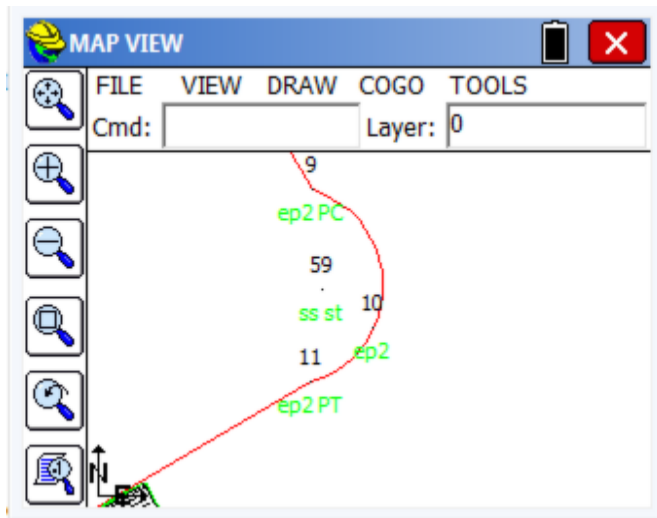

To remove the bulge in the arc and make it tangent, add code "AFIT" to point 10. If Line Details are clicked on within Configuration, the

moment you add the text (click 10 directly in map screen and edit it), the line will redraw as shown below. In the field, if you add AFIT ahead of time, anticipating a bulging arc, it will draw correctly in the field.

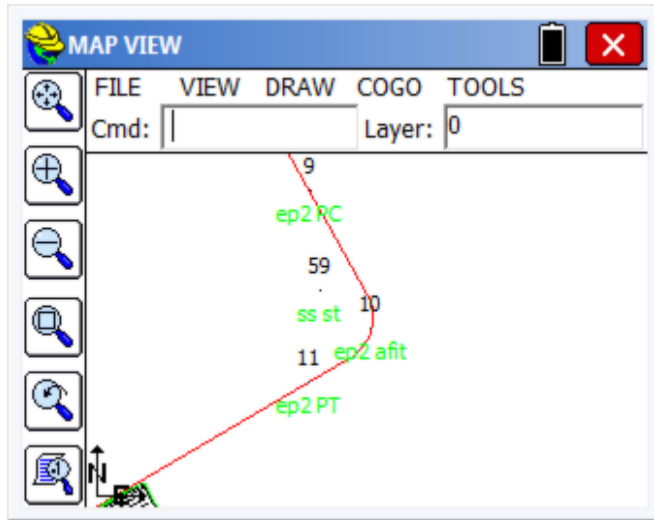

CIR: The Close Circular special code works 3 ways. First, with a single, measured point including a radius distance, it will draw a circle, as in CIR2 for a 2 meter or 2 foot radius (depending on units).

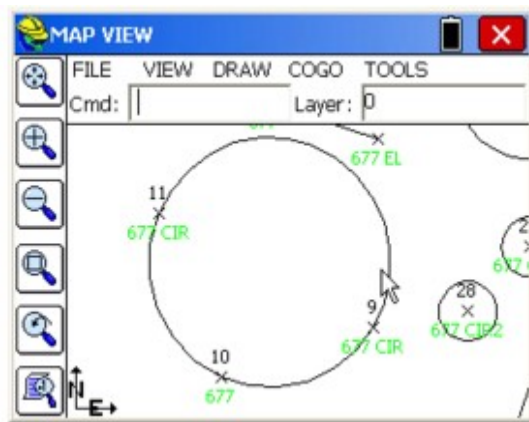

Secondly, if 2 points are used, then the radius becomes the mid-point of the 2 points and a circle will be drawn through both points with the entered radius:

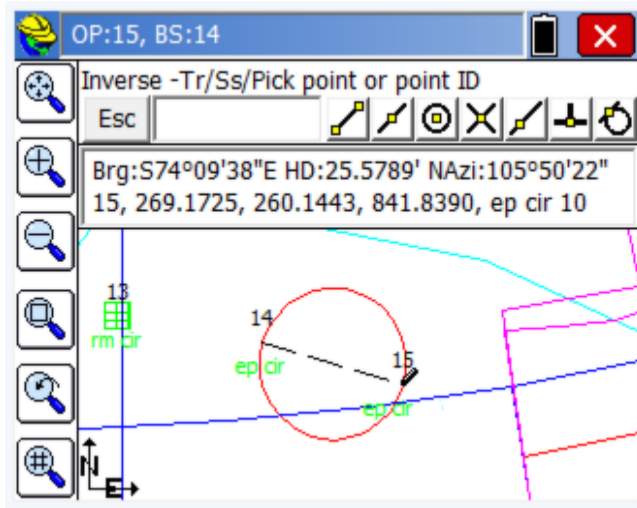

Third, if 3 points are entered as in 9 code CIR, then 10 code, then 11 code CIR, the third point defines a unique circle without user entry of the radius. This is shown in the above graphic. The code used must be a linework code (like EP for edge-of-pavement), not a point code, for the circle to be drawn.

Using Short-Cut Icons to Append Special Codes

With the Prompt for Height and Description turned on within Configure, you have the opportunity to choose from your existing descriptions saved in your Feature Code List, whenever you store points. You also have the ability to select icons for the special codes as shown here:

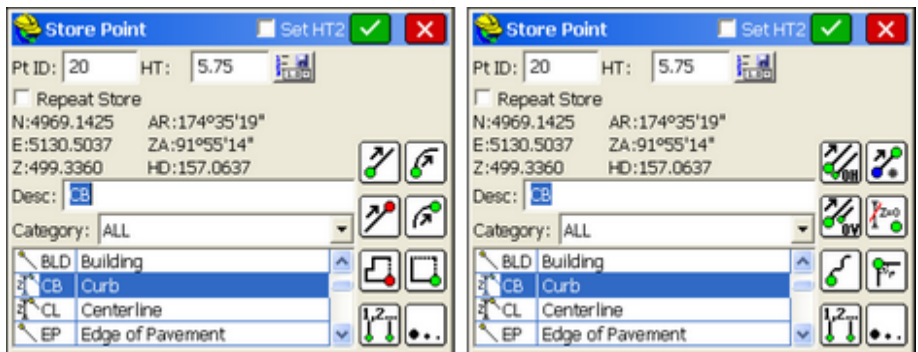

On the first page, these codes going from top to bottom, starting at the left, represent start line, end line, close line, select active line (when multiple lines are being drawn with the same code), start curve, end curve, rectangle, and "more". When you pick more, the options are offset horizontal, offset vertical, smooth curve, select active line, join to point ID, no elevation, jog and more (return to first set of icons).

Pre-Formatted Special Codes

SurvCE has several pre-made files of codes used by certain highway departments and others. These can be selected from the drop list by selecting **Special Codes** within the **Feature Code** command. The actual DOT code files (at right below) can be loaded from the Knowledge Base on the Carlson website, as outlined below.

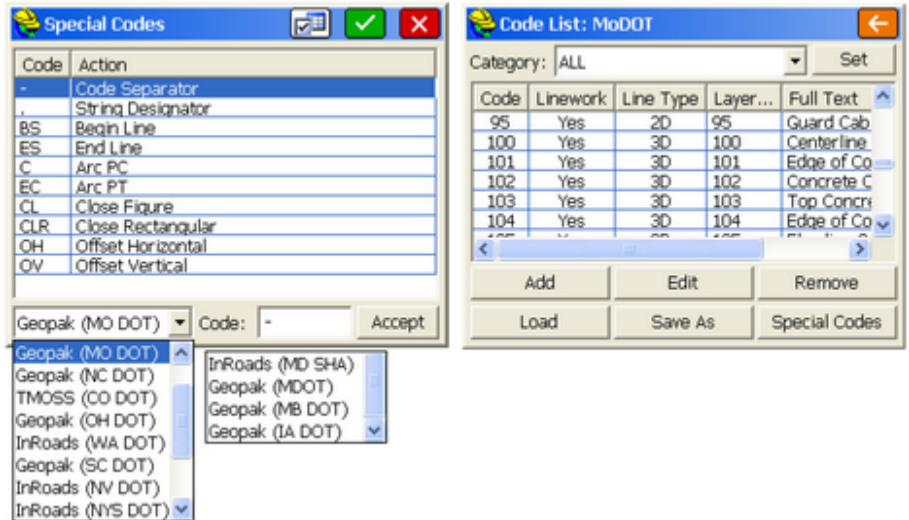

When a specified format is selected such as Geopak (MO DOT), the standard codes all change, including the separator code. Whereas for normal coding, a space is used to separate a description from a special code (eg. EP PC), with MO DOT coding, a "-" (dash) would be used as the separator, as in EP-EC. The users of these systems need to be familiar with the required coding. For example, with Geopak (MO DOT) coding, a typical edge of bituminous survey might be coded: 201-BS, 201, 201, 201-C, 201-C, 201-EC, 201, 201-ES. Note that Geopak requires a start line and end line and requires coding on all arc points (C or EC). This coding will process correctly in SurvCE, but SurvCE will also process this coding if the "-BS" is omitted on the first measurement. Use of the special icons within the Hgt/Description prompt screen will append the correct special codes that are active. Geopak also requires points to process linework, so it will not respond to the OH feature and the CLR feature, unless "Create Points for All Linework Elements" is turned on within Settings. (This option appears only if the program detects coding systems requiring the option). Otherwise, OH will create offset lines, for example, with no associated points.

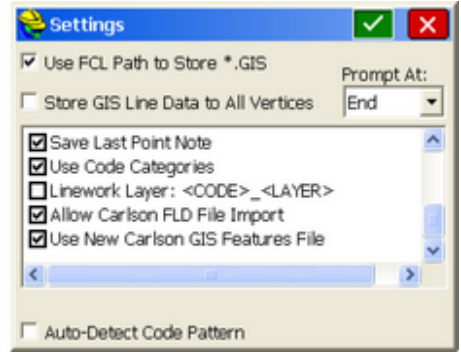
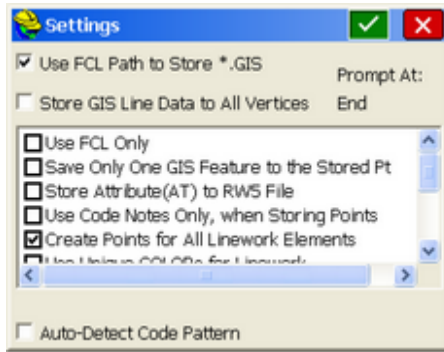

The various coding systems used by different state highway departments can be loaded at the following locations:

The DOT FCL files are all available at www.carlsonsw.com - Support - Knowledge Base, article 388.

Category: SurvCE

Topic ID: 388

Title: DOT Feature Code Lists

Also, the following link will open the Knowledge Base 388 article.

http://update.carlsonsw.com/kbase_main.php?action=display_topic&topic_id=388

Other Settings

Use FCL Path to Store *.GIS: It is recommended that this option be clicked on. If your feature code file is in the \data subdirectory, then the ".GIS" files which contain attributes will be placed in the \data subdirectory also. This keeps the attribute prompting linked to the feature code (.fcl) file. If GIS attributing is being used, you can store the GIS data directly into any special subdirectory used for the applicable Feature Code List. So if you maintain several feature code lists, each with attributing specified for certain descriptions, the GIS attribute data can be placed in the directory of the associated feature code file. The only advantage of turning this off is if you wanted attributing to be associated with the job file as opposed to the feature code list.

Store GIS Line Data to Vertices: When lines are created by field coding, points at the vertices are also created (except for features created by RECT and OH). In addition to associating attribute data with the linework itself, you can click this option to store the GIS attribute data to each point on the line that was surveyed.

Use FCL Only: If this option is selected, the Height/Description prompt screen shows only the feature codes in the list, and will not display others descriptions used in the current job. This simplifies the code selection process when the goal is to more strictly limit codes to those in the list. However, you will obtain extra prompting when you use different coding, not in the list (see below).

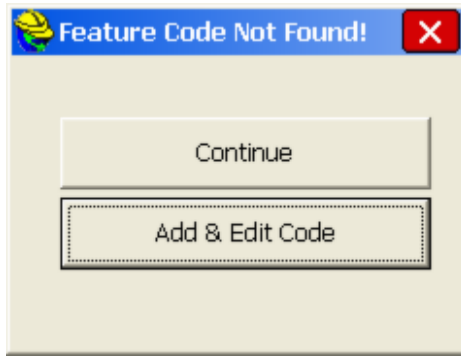

Save Only One GIS Feature to the Stored Pt: When two codes are entered for the same point, separated by a space, and both codes lead to GIS prompting, only the first code will be used for the GIS prompts and stored attributes.

Store Attributes (AT) to RW5 File: All attribute data will store at "AT" records in the raw file. For example, multiple attributes entered for a manhole might appear as shown below. The name of the attribute is identified with a "TN" prefix and the value of the attribute is identified with a "TN" prefix.

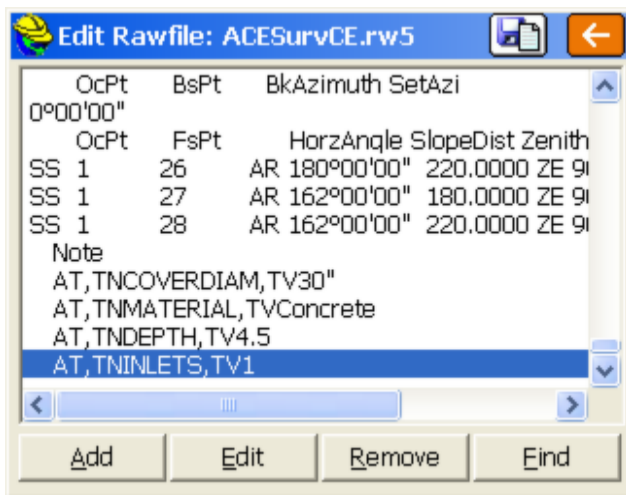

Use Code Notes Only, when Storing Points: This is a method that allows storing more than 31 characters for point descriptions (the normal limit for CRD files). First, you must turn on "Prompt for Point Notes" within Configure. Then, a code such as "CP" can be associated with a long note, such as "Control Point from City Record Book 12-A". You would then select that single note each time, and save typing of notes. The notes can then be exported with the points using **File, Import/Export**. Using File Export, one technique is to set the delimiter on the coordinate values (Pt ID, N, E, Z, Description) to comma and on "Other" (eg. the note) to Space. In this way, within File Export, you can append the long note to the description as a single field to be imported and used by any office software.

Another use of this option is to limit the list of notes that appear to just those

associated with the Feature Code. For example, if you want to use Notes to describe the type of tree just measured in association with code "TR", then you can use the "Notes" option within Feature Codes, option Add or Edit to establish the list of trees as Notes, and then only that list would appear if "Use Code Notes Only.." is clicked on. Shown below at left would be all recent notes, then the more limited list with "Use Code Notes Only" turned on.

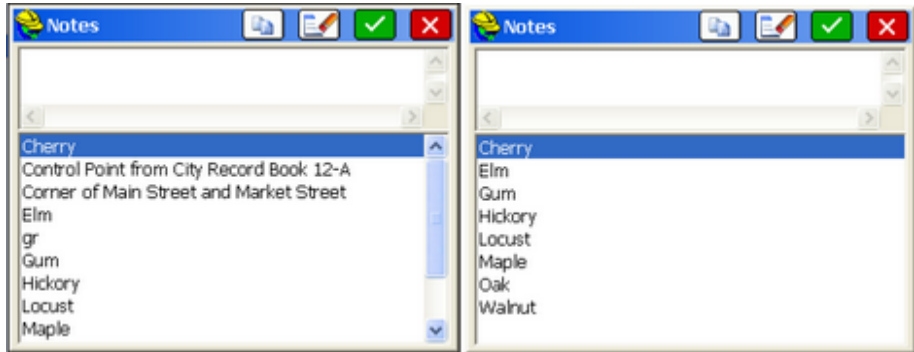

The 4 buttons along the top of the dialog represent Select Note, Clear Note, OK and Cancel.

Create Points for All Linework Elements: When using OH or other codes such as RECT for Rectangle, this option creates a Point ID at all vertices of linework, whether surveyed or created by the software. Some office software packages, like earlier versions of Geopak, required point IDs to process coding. Points are increments sequentially from the last entered point. The option only appears when certain special code formats are selected, indicating linkages to office software needing Point IDs.

Use Unique Colors for Linework: Produces different colors, increasing sequentially from 1 to 7 (Autocad (r) color conventions), for each new version of the same feature code (eg. EP). After color 7, it goes to other distinct colors.

Use Unique Layers for Linework: This appends numbers to the linework layer as you make new lines for the same feature code. So if EP makes lines in the ROAD layer, then the first EP line goes to ROAD1, the next line to ROAD 2, the third line to ROAD3, etc.

Use Last Point Note: Recalls and applies to the newly stored point whatever point note was used last.

Save Last Point Note: With this On, all notes that are entered are saved to a file of notes making a Note List (see above graphic). Then users can select previously entered notes from the list, to save typing in the field.

Use Code Categories: When On, Categories appear in the Feature Code List and descriptions can be associated with Code Categories for easier sorting. With the option Off, Categories do not appear in the Feature Code List, and an additional 2 lines of Feature Codes (8 total) can display at one time based on the extra space made available.

Linework Layer: <CODE>_<LAYER>: This option changes the layer dynamically by appending the code to the layer. So if both FH (fire hydrant) and

MH (Manhole) are defined to be in the Utility Layer, this option will place them in the FH_Utility and MH_Utility layers.

Auto-Detect Code Pattern: With the option selected, the program will look for patterns of cross-section style coding, particularly applicable to roads and ditches. In the most simple example, consider a ditch or stream being surveyed to 3 points: (TB for Top of Bank, DL for Ditch Line and TB for Top of Bank on the opposite side). So consider the Left-to-Right pattern of surveying below:

TB1, DL, TB2
TB1

Right at the point of entering TB1, the program will detect a pattern and will assume the next point is DL and the point after that is TB2, and will default to prompting for that coding. Similarly, consider a L to R then R to L survey:

TB1, DL, TB2
TB2

In this case, with **Auto-Detect On**, the program will prompt next for DL and then for TB1, and then TB1 again, DL and TB2. This same pattern recognition applies to 5 point cross sections such as CB1, EP1, CL, CB2, EP2 and any number of pattern-based cross section examples. When a new pattern is detected and the program is about to launch into auto-assignment of descriptions, you will be prompted:

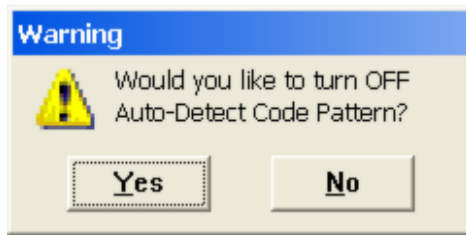

You can survey points outside the pattern by simply entering a different code. The program will then resume auto-assigning the code based on the recognized pattern. Whenever Auto-Detect is on, it is advisable to review the automated code to be certain it matches what is intended. The button: "1.2.." in the HGT/Desc dialog gives you the option to:

- turn ON/OFF auto-detect pattern.
- check the codes that are making the pattern.
- skip a code.
- clear the codes that are making the pattern.

Line Details

When conducting field measurements in the command Store Points, if an existing line created by Field Codes is clicked, on the line but away from the corner points (to avoid Point Details), then an advanced "Line Details" option appears as shown:

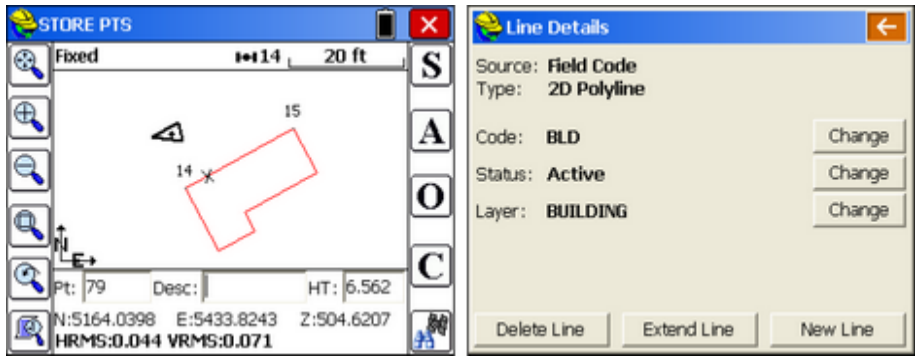

The line from 15 to 14 is picked near the X shown at left. Because the picked position is sufficiently distant from the corner point, the program recognizes that a line has been selected and "Line Details" options appear. If the line is extended, it will extend from point 15 based on the next measured point. If the line is deleted, it will be erased. Codes, status and layers can be changed. If the goal is to start a new line from the nearest endpoint (14) to the next measured position, then the "New Line" option would be selected. The new line could be a fence line in a completely new layer, as shown below:

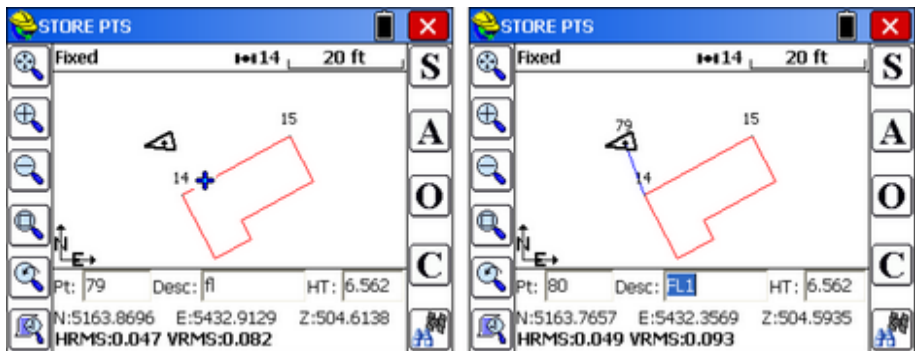

In this way, new lines can start from end points of existing lines without the need to re-survey them (which saves time and is particularly beneficial in high-traffic areas). Even though only one new measurement was taken in this example, a 2-point line is drawn, and the code for point 14 is updated to include the original text as well as the new text. The program cautiously uses both the start code (ST) and the concept of the numerical version of the code (FL becomes FL1, first fence line) to start the line, even though the combination of FL1 and ST is redundant. If point 79 is the end of the line, and "END" is the special code to end a line, then point 79 is coded FL1 END.

ation	Description	Pt ID
603	mh	11
600	mh COVERDIAM:30" MATERIAL:Preca	12
600	MH NE COVERDIAM:30" MATERIAL:Pr	13
603	BLD ST FL1 ST	14
603	BLD Joq 12 20 -5 10 17	15
636	CB	20
603	ep	21
603	ep	22
603	ep	23
603	ep END	24
603	ep	25

Buttons: Edit, Add, Find, Delete

Even though point 79 was the newly measured point, point 14 is auto-updated to include BLD ST FL1 ST (start building, the original code and start fence line, the new code). The Line Details process therefore saves field measurement time and field coding time. Line Details, like Point Details, is a transparent or "context-sensitive" command. Simply pick the line or point, without issuing any command, and the options appear. If you do so within the Store Points "context", additional prompting occurs as discussed above. This also applies to Point Details, as described below.

Point Details

When conducting Store Points and using Field Codes, the picking of a point on the screen, in this context, allows for the re-measuring of the point, to correct the field-to-finish linework and symbol placement. (Even if field codes are not being used, picking any point within Store Points allows for re-measurement of the point.) So in the example above, picking point 79 leads to the screen shown below, and the new result if re-surveyed. The original field code will be the default description, but you have the option to change it.

Point Details

Point ID: 79
 Northing: 5163.7772 ft
 Easting: 5432.4186 ft
 Elevation: 504.6112 ft
 Description: FL1 END

Buttons: Edit, Delete, Re-Measure Point

STORE PTS

Fixed 14 20 ft

Map showing points 79, 14, and 15.

Pt: 79 Desc: FL1 END HT: 6.562

N:5151.6971 E:5414.2943 Z:504.6138
 HRMS:0.041 VRMS:0.092

The result of the new measurement is shown below:

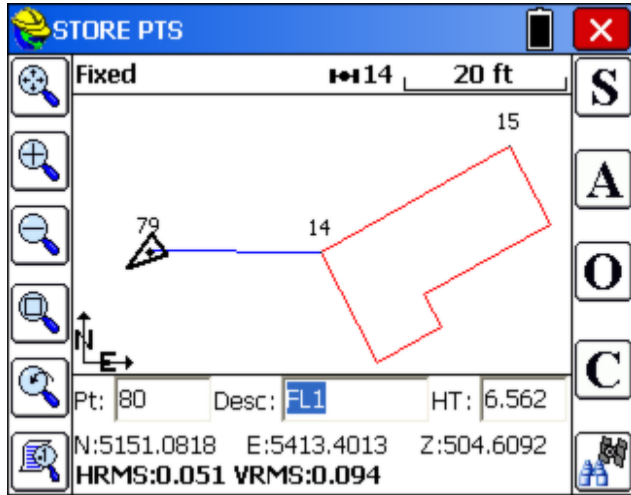

Reprocessing the Field Codes

Using the command **Field to Finish**, found under the Tools pulldown menu in the Map screen, you can reprocess your field codes after editing any aspect of your point data. So if you left off an "end line" command, you can edit the point, change the description, and re-process the linework. In the example using the code RECT25 above, if you edited that point and changed it to RECT50, it would draw a twice as large building when you run **Field to Finish**, and RECT-25 would draw the same building but instead in the opposite direction. If you click on Show Line Details under Configure, this reprocessing is fully automatic whenever a graphic screen is displayed, whether in active survey commands or by going to the Map screen.

Data Transfer

This command prepares Carlson SurvCE for transferring data to and from a desktop PC or to a USB stick (thumb drive). For Data Transfer to a PC, a program on the PC must be running to receive and send files. SurvCE, using the Data Transfer option, must "handshake" with the program on the PC in order for the transfer to be successful. A serial cable must connect the PC to the handheld device running SurvCE. COM ports must be identified correctly, as well as baud rates. For data collectors with a standard USB port (such as the Carlson Surveyor and Surveyor+), it is only necessary to insert the USB thumb drive into the port. The USB transfer option is part of the "Copy to Storage" feature.

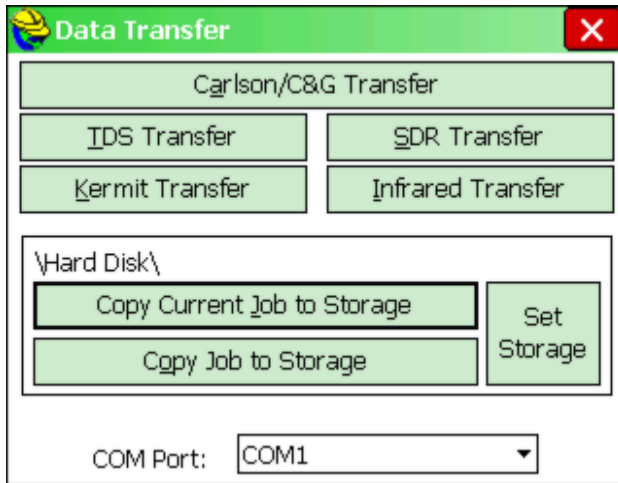

- Carlson/C&G Transfer:** This option is designed to work with Carlson Software and C&G office products (Carlson Civil, Carlson Survey, Carlson Survey Desktop, Carlson Connect in older Autodesk products, X-Port, CG Survey and SurvNET). It also works with the standalone SurvCom program that is included with the purchase of SurvCE. The handshake is designed for simplicity and robustness. Carlson Software products use the same native file formats as SurvCE, so no file conversion occurs— only transfer.
- TDS Transfer:** This command is used to transfer data from SurvCE to TDS Foresight or other programs that have a TDS Link routine.
- SDR Transfer:** This command is designed to work with existing programs that communicate with the SDR. For example, if you have LDD, Intergraph, SurvCADD/Carlson Civil, SelectCAD or other software that contains an SDR33 transfer routine, then this option is designed to mimic that protocol. When an RW5 file is selected, it is automatically converted to a Sokkia RAW file and downloaded to the PC. When a CRD file is selected, it is automatically converted to a Sokkia RAW file with “08” records for points. This allows you to use and process the data in SurvCE similarly to the data in the SDR33. You can also upload into the SurvCE field computer Sokkia RAW files that contain point records. All the points will be stored in a CRD file on SurvCE.
- Kermit Transfer:** This command leads to a send and receive screen that works with the Kermit program on the PC. This is a readily available data transfer program.
- Infrared Transfer:** Only available on data collectors with infrared capability. This command leads to a send and receive screen that works with the Window Socket IrDA server/client objects only between two CE mobile devices. This is a readily available data transfer program. It works, for example, from Ranger to Ranger. Please make sure you align your devices so that the infrared transceivers are within one meter of each other, and the transceivers are pointing at each other. For an easy connection it is preferable to start first the server (the device that will receive the data file) and after that

the client (the device from which the data file will be sent).

- **Set Storage:** This option should be selected prior to choosing "**Copy Current Job to Storage**" or "**Copy Job to Storage**". The "Set Storage" option allows you to set where the "Copy to Storage" commands will place the files. Where USB output is available, the USB (thumb drive) port is designated as "Hard Disk". You can also store to the CF Card, which is the "Storage" option, and you can store to the SD Card. On the Carlson Surveyor and Surveyor+, the USB thumb drive (Hard Disk option) is the default.

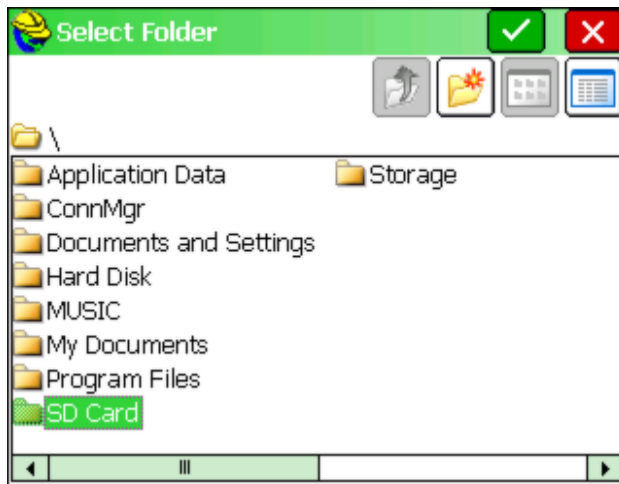

- **Copy Current Job to Storage:** This copies the entire current Job, all files associated with the current coordinate file (CRD file), to the selected storage option. This would include the RW5 file, the DXF file (drawing portion), the VTT file (containing GIS data), basically every file sharing the same name as the CRD file.
- **Copy Job to Storage:** This copies the selected Job or CRD file to storage, which can be different from the current file. When the current job or selected job files are copied, the program displays: "Process Done".

Sending data to a computer using the Carlson Transfer Option

1. Connect your serial cable to your PC. Select **Data Transfer** from the **File** menu. Choose **Carlson/C&G Transfer**. This leads to a File Transfer screen on SurvCE, which prompts "Awaiting Connection". All further action takes place on the PC side. There is no time delay in this handshake. SurvCE will wait for the PC program to catch up. When you connect the cable from SurvCE to the PC, Microsoft ActiveSync may interfere and display "Connect to PC?" If you get this question, select **No** and on your PC, disable the Microsoft ActiveSync serial linkage if it is on.
2. Execute SurvCom, or for Carlson Survey or SurvCADD/Carlson Civil users (July, 2001 build or later), choose **Survey, Data Collectors, Carlson SurvCE/CSI Mobile** option. If you get "Failed to open COM 1 error code -3", the most likely errors are lack of cable connection or interference by

Microsoft ActiveSync. If connection is automatically established, SurvCE will display, "Connected to PC".

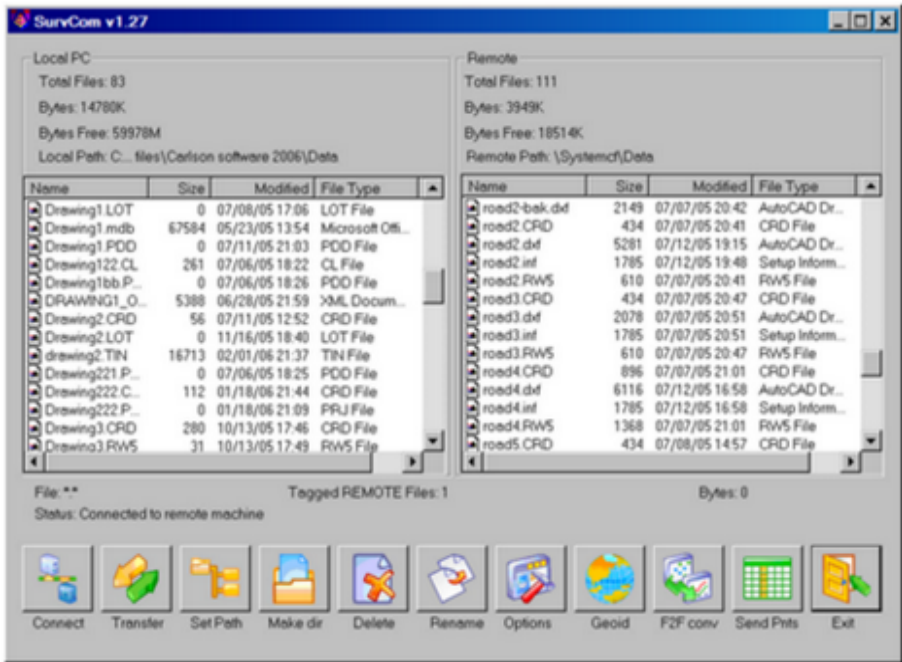

3. If only the left side of the screen on the PC displays data, then you do not have a connection yet. Press the **Connect** button located at the bottom left of the file transfer dialog. The transfer program will respond with "Retrieving File List". Once the file list has been retrieved, the left side of the dialog box will show files located in the specified path on the PC, and the right side of the dialog will show the files located in the designated path on the remote. You can change directories by scrolling to the top of the file list and choosing **Up One Level** (just like in Windows). In the above dialog, a filter is applied so that only files in the form of *.crd are displayed. Filters such as this can be set up using the **Options** button.
4. To transfer one or more files, simply select or highlight the desired files and select the **Transfer** button. More than one file can be transferred from the remote to the PC or from the PC to the remote during the transfer process. Standard Windows selection options apply. For example, selecting one file and then, while pressing the shift key on the PC, selecting another file deeper on the list, will select all the files in between the first and last selected. You can also select the first file to transfer and press and hold down the shift key and use the down arrow to specify the range of files to transfer. Pressing and holding the control key on the keyboard allows for the selection of multiple files in any selection order, by picking the files with the left mouse button.
5. After the files have been selected, press the **Transfer** button. When the transfer is complete, the program will display the "Transfer Complete" message and will then proceed to update the file lists on the PC and the Remote.

Note: The process of importing points to the data collector mimics the process of exporting points to the office computer, but in reverse. If a point is found to already exist on the data collector, options appear to Overwrite All (Yes All) or Cancel All (No All).

SurvCom Commands

These commands are found and can be seen in the SurvCom dialog box shown above.

- **Connect:** After selecting Data Transfer from the File menu, press this button to connect to the PC. Once connection is made, the status line on the file transfer utility dialog box will show "Connected to the remote machine".
- **Transfer:** Pressing this button transfers selected files from either the Remote to the PC, or the PC to the Remote.
- **Set Path:** This option allows for the specification of the desired source and destination drives and folders for both the PC and the Remote device. For example, if you were downloading, or copying files from the Remote device to the PC, to specify a source path on the remote device, select the Remote Machine toggle and then type in the desired path in the path field. To specify a destination path on the PC, select the Local PC toggle and type in the desired path the path field. When a change to either path is made, the transfer utility will retrieve a new file list from the specified paths.
- **Make Dir:** This option allows for creation of directories on both the PC and the Remote device. Specify the machine to create the directory on and then enter the directory name.
- **Delete:** This option allows you to delete the tagged files.
- **Rename:** Select a file and rename it.
- **Options:** This command allows you to set various options for data transfer. The dialog shown in the figure below will appear.

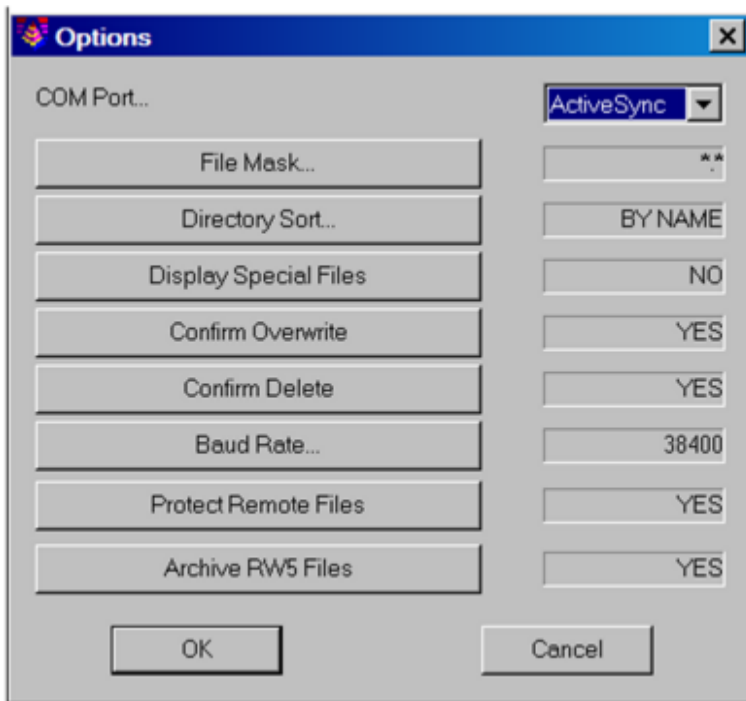

Com Port: You must select which com port on the PC to use.

File Mask: You must select a file filtering syntax.

Directory Sort: You must select how to sort the list of files.

Display Special Files: Toggle whether or not you should see special files.

Confirm Overwrite: Check this to confirm before overwriting files.

Baud Rate: You must choose the baud rate for transferring data.

Protect Remote Files: Check this to protect files on the mobile device.

Archive RW5 Files: Toggle YES or NO.

- Geoid:** This command will carve out a portion of the Geoid 99, EGM96, Canadian CGG2000, Canadian HT2.0, Canadian HT1.01, Australian GDA94 and Great Britain OSG-MO2 grid files and send it to SurvCE. Since these geoid grids are very large, the program carves out a precise portion of it and avoids overloading the memory on the remote device running SurvCE. You will be prompted for the directory, on the PC, of the source Geoid grid file, and the approximate latitude and longitude of the job, and the size of the area desired in miles, kilometers or degrees of latitude and longitude.

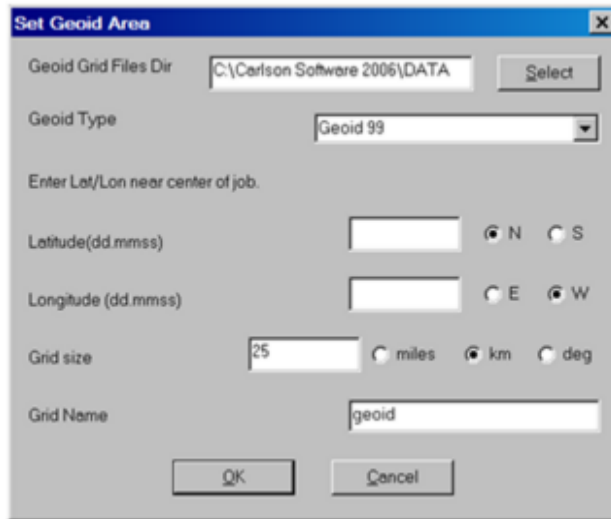

- **F2F Conversion:** This converts the more thorough and detailed Carlson Survey field code file (for field-to-finish work) to the more simplified Feature Code List that runs in SurvCE. The Feature Code List in SurvCE handles Linework (on or off), Line Type (2D or 3D), Layer (= Code) and Full Text (Description).
- **Send Points:** The command allows for the sending of a range of points.
- **Exit:** This command will exit the File Transfer Utility
- **Bluetooth Transfer:** If the mobile device has a Bluetooth emulated serial COM port, the user will be able to select it from the list, and transfer data from/to another device that has Bluetooth available.

Import/Export

This command allows you to import an ASCII file to job data or export job data to an ASCII file. When you choose this command, you will see a secondary dialog in which you will be prompted to choose to Import or Export.

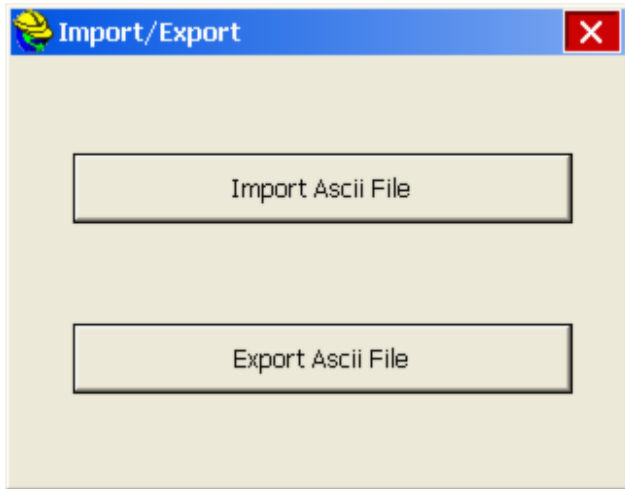

Import ASCII File

This command converts point data from an ASCII text file into the SurvCE format. The source ASCII file can contain any combination of point number, northing, easting, elevation, and description. You may select any of the predefined formats or create your own custom format. Since some of these source file formats (like Carlson CRD and TDS CR5) are not ASCII but are actually binary, Import ASCII file can be used to import points from certain non-ASCII type files. This next figure shows the Import ASCII dialog box.

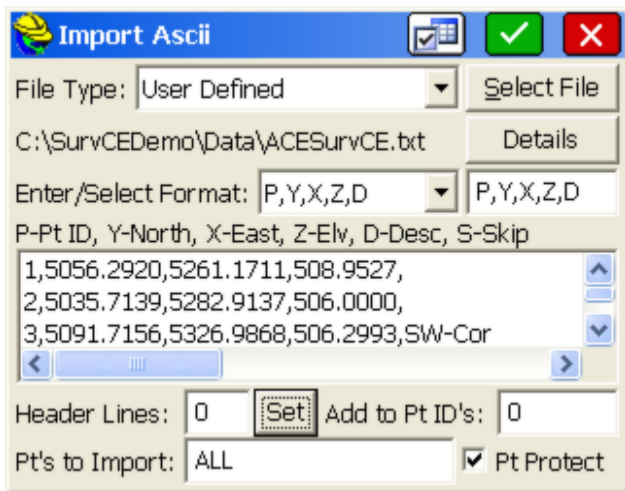

- **Source File Format:** You must choose the format of the source file. The choices include

User Defined: For importing most .TXT and .ASC files. The coordinate order in the Choice field is used.

Traverse PC: For importing Traverse PC .TRV files.

TDS: For importing TDS .CR5 files. Note that CR5 files can contain point numbers in excess of 32760. If point IDs exceed that value, it is best to set **Alphanumeric** as the point ID type under **New Job** in **Job Settings** prior to importing.

Geodimeter: For importing Geodimeter .OBS files.

Trimble POS: For importing Trimble .POS files.

CRD File: Allows you to import a SurvCE CRD file into the current, active CRD file, and set the range of points to import. Note that this method can be used to move a subset of points from one CRD file over to another file, as shown below. You can import "All" points or just points 101 to 110, as needed.

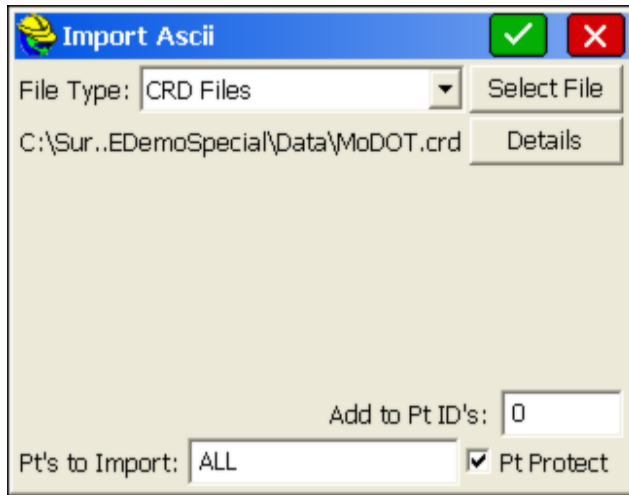

SDR File: For importing point data within Sokkia SDR files.

MMH File *.360, MOSS, SDMS, CAICE: Other formats that can be imported. SDMS, for example, is a format for both points and raw survey data that was developed by AASHTO.

- **Select File:** Type in or browse for the name of the file to import.
- **Details:** Only after a file has been selected, **Details** can be clicked to show the range of points detected in the file.
- **Enter/Select Format:** If your Source File Format is set to User Defined, choosing one of these settings copies the contents into the Choice field, which will be used to import the file.
- **Choice Field:** If you are importing an ASCII file with a special form (e.g. A,Survey,1254552.123,498135.12,1109.23,iron pin,54) then you want a format that skips the first two columns (A and Survey) and does Easting (X), Northing (Y), Elevation (Z), Description (D) and Point ID (P), so your format will be: S,S,X,Y,Z,D,P. If there is no point ID in the ASCII file, you simply omit the P in the entered format, and the program will prompt for a starting point number or ID and will number each subsequent point sequentially.

- **Preview:** Shows you a preview of the first line of the ASCII file. This is helpful in determining the correct coordinate order format.
- **Header Lines:** Specifies the number of header lines to skip in the ASCII file.
- **Set:** First highlight the last of the lines in the "Preview" that you want to skip, and then clicking this button sets that specific number of header lines to skip. If all the display lines are valid coordinates, you would not use the "Set" option and would enter "0" header lines to skip.
- **Add to Pt ID's:** Specifies a value to be added to each point ID during the import process. If you added a value of 100, then point 1 would become 101, point 2 would become 102, etc.
- **Pt Protect:** Specifies whether or not to check each point ID to see if it already exists in the current CRD file. If this is toggled **ON** and you attempt to import point ID's that already exist, you will then be prompted to overwrite each existing point or to cancel the operation.
- **Settings:**  Notes can also be imported and will associate with point IDs. Settings allows control of the separator used between the point ID information and Note on the ASCII Import (comma, tab, space or "other" as specified).

Export ASCII File

This command converts SurvCE point data to an ASCII text file. The next figure shows the Export ASCII dialog box. Choose a coordinate order, type of delimiter, range of points and precision. After choosing the settings in this dialog box, press **OK**. A standard file dialog will appear. In this dialog, choose a name for your ASCII file and then press **OK**. After the file is written, a dialog will appear telling you that the conversion is finished.

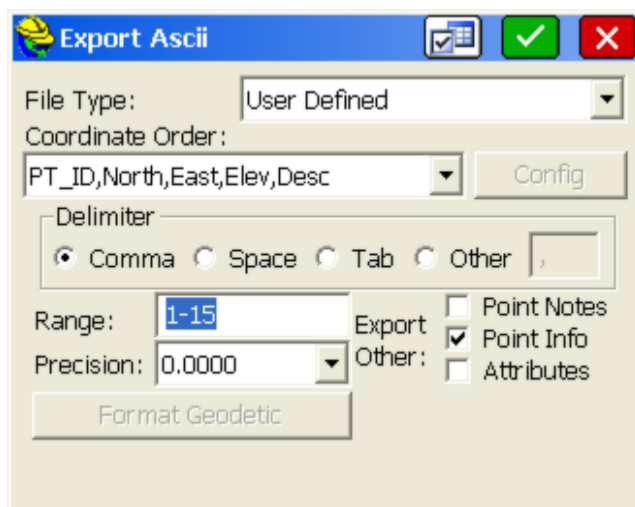

- **Coordinate Order:** You must specify the output format for the ASCII file. There are seven different formats to choose from. The last field is always the description. The fields can be space, comma or tab delimited, and you can

also separate the fields by a user-defined delimiter. Two of the options include quotes around the description field so that your descriptions can include spaces and/or commas. An additional option, "Custom", appears at the bottom of the drop list. If this option is selected, the "Config" button becomes active.

- **Config:** With Custom selected for Coordinate Order, Click "Config" to see the dialog options below. Note that if Latitude and Longitude is included in the output, the "Format Geodetic" option in the dialog also becomes active.

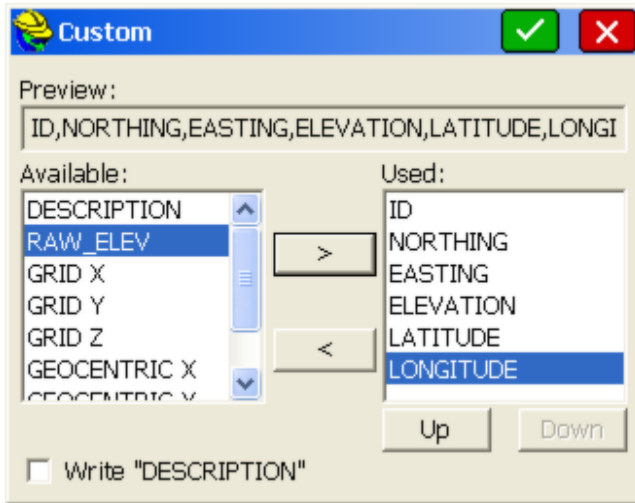

- **Type of Delimiter:** You must specify the character used for delimiting the fields in the output ASCII file. You may choose either a space, comma, tab or user-defined delimiter.
- **Coords vs Other:** As shown in the first graphic above, you can use one delimiter for the coordinates and another for the "other" information such as notes and GIS attribute data. If, for example, you had notes that were types of trees associated with the "TR" description, then the tree type could be appended to the code TR with a space, as in TR OAK, and export as a single field. You can control whether or not you choose to export notes, point info and point attributes.
- **Range:** You must specify the range of points to output. Ranges can be separated with commas, as in 1-40,101-199,A1-A44.
- **Export Notes:** When this option is enabled, any point notes associated with the current job will be exported to a .NOT file. These files are used with SurvCADD (and other Carlson office software products).
- **Export Point Info:** This exports any "known" information about the point, such as HRMS and VRMS values that have been included automatically in the Note file.
- **Export Attributes:** GIS attributes can be assigned to points that are stored based on settings in the Feature Code List. If a point that is shot is a manhole (e.g. MH) and attributes such as concrete, 5 rungs, 2 inlets are entered for this

point, these attributes will be exported to an ASCII file for use by external programs when this option is enabled.

- **Precision:** You must specify the output precision for northings, eastings, and elevations. This setting does not affect point IDs or descriptions. After choosing the settings in this dialog box, press **OK**. A standard file dialog will appear. In this dialog; choose a name for your ASCII file and then press **OK**. After the file is written, a dialog will appear to let you know that the process is finished.
- **Format Geodetic:** Based on setting of Custom for Coordinate Order, and use of Latitude and Longitude in the export "used" list, the Format Geodetic button becomes active. You can select from many Geodetic formats for the Lat and Long, plus control notation and location of the notation, as shown below.

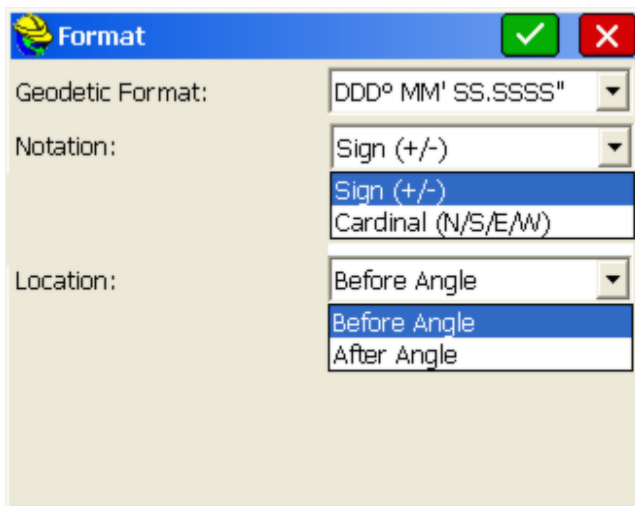

This next figure shows the result of exporting a job to an ASCII file.

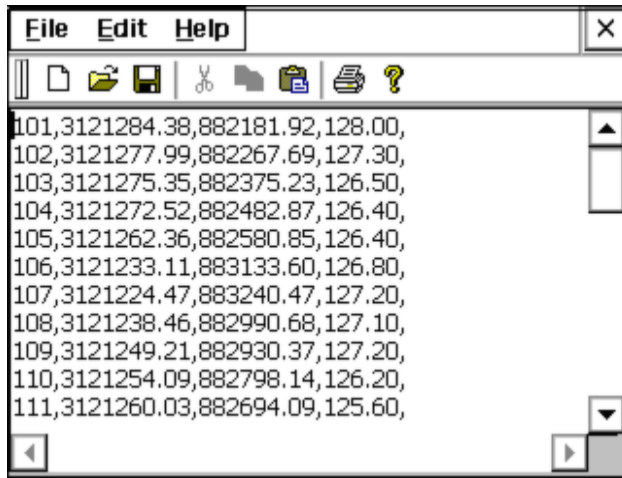

Delete File

This command allows you to remove any existing file from any directory to free up memory. This figure below shows the standard file selection dialog, where you can choose the file name to delete.

Note: It is always a good idea to back-up your data by transferring it to a PC before deleting files. Carlson SurvCE does not require you to back-up your data before deleting.

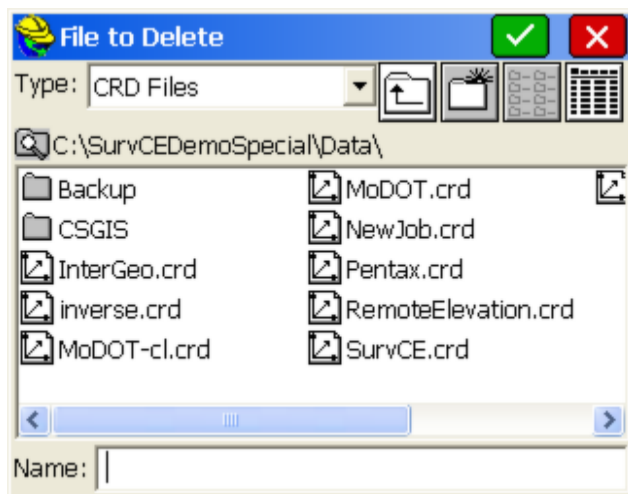

Select the file you wish to delete from the standard file selection dialog box and pick **OK**. SurvCE will ask if you want to delete all files associated with the job (eg. the .dxf file, the .rw5 file, etc.).

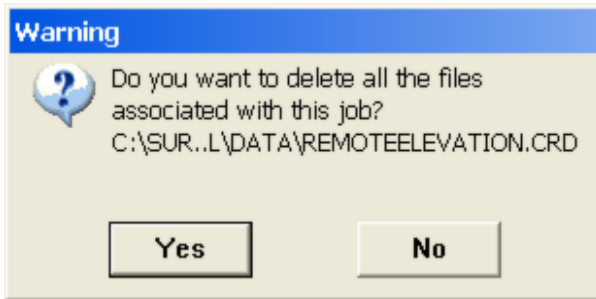

Press **Yes**, if you wish to continue. SurvCE will then warn you if the file or files to be deleted have never been downloaded before.

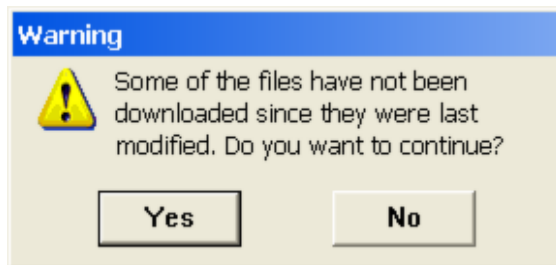

Press **Yes**, if you wish to continue. You will be asked to confirm your file selection once more. Press **Yes** to accept the deletion of the file or files, or **No** to cancel the selection.

Add Job Notes

This command allows you to enter job notes as ASCII text. These notes are saved with the job in the raw data file.

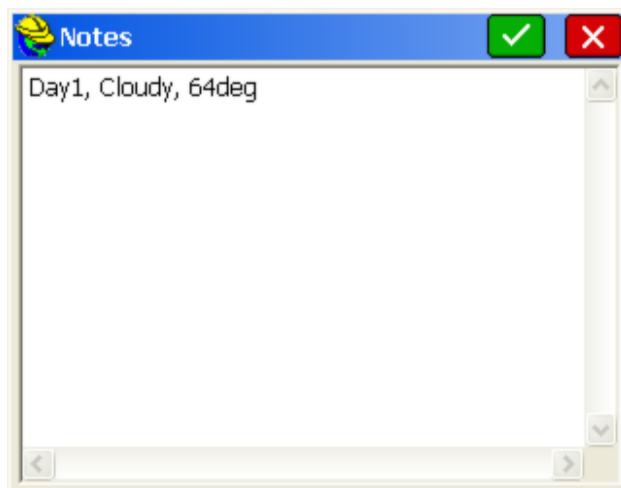

Exit

This command will exit the Carlson SurvCE program. The software presents the confirmation dialog.

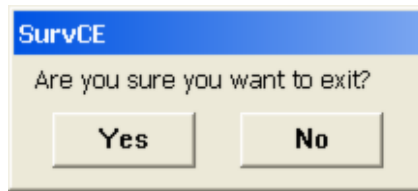

If you choose **Yes**, SurvCE will exit and your data files are saved. If you choose **No**, SurvCE does not exit.

EQUIP

This chapter provides information on using the commands from the Equip menu.



Total Station

The Total Station routine allows the user to configure their total station communication and operation settings. The tabs shown are configured based on the selected instrument (see specific instrument for details). It is recommended to go left to right through the tabs, from Current to Comms to Settings to Search, to ensure that all settings are correct, especially when first configuring a new instrument. Click the green check mark (not the red X) to accept all changes and continue. Some models of equipment do not have Settings or Search.

Current Tab

Select first the manufacturer and then the model. The routine also provides an instrument recall feature that allows the user to store and recall all instrument-related settings as a user named configuration. Configure all of the settings as desired, and select the save button to name and store the custom configuration. Settings that will be retained are as follows:

- Instrument Settings
- Communication Settings
- Configure Settings
- Stakeout Reference Settings

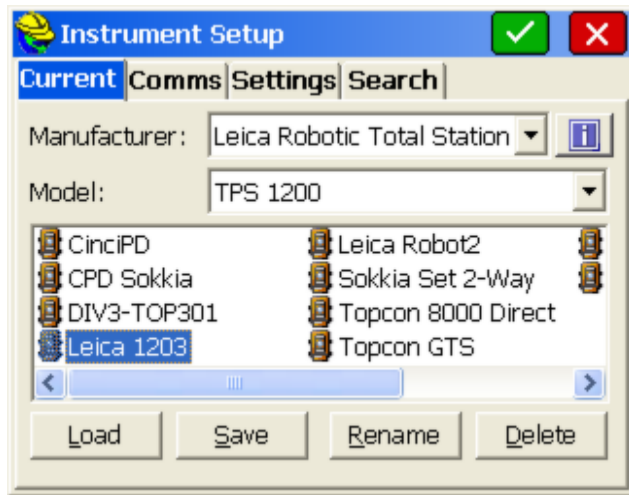

- **Load:** This button will load all settings defined by the selected icon.
- **Save:** This button will save the current settings and allows the user to enter the name of new icons that will be created to represent the instrument settings.
- **Rename:** This button will allow the user to rename the selected icon.
- **Delete:** This button will remove the selected icon.

Comms Tab

There are 3 Comms options: Cable, Bluetooth, Radio. The Comms tab allows you to specify communication parameters for the data collector. For most total stations, communication is by cable. For many newer total stations, there is a Bluetooth option. Bluetooth itself has 2 methods found within the "Device" option: Windows Mobile (preferred) and Generic. The user can detect if there is any Bluetooth emulated serial COM port available on the Windows Mobile data collector by looking for the Bluetooth icon or application. Typically, COM 1 and COM 2 are reserved for serial cable connection, so Windows Mobile will use higher COM ports to emulate the connection by Bluetooth. It is recommended to choose COM4 or higher for the Bluetooth COM port. This is done outside of SurvCE, using features of the Windows Mobile device. If the Generic Bluetooth method is selected, then the user can choose the COM port for Bluetooth as prompted within SurvCE. SurvCE can use Bluetooth to communicate only with instruments that have Bluetooth capability. Some total stations have Bluetooth passwords (PIN #) such as "0000". The user can find the Bluetooth device and can change the name and the password for the Bluetooth present on the instrument by using the "Bluetooth Settings" button (the tool icon). In many commands such as Store Points and Stake Points (in Surv Menu), there is a Bluetooth "Reconnect" option found under the Helmet icon (upper left), for quick reconnection if Bluetooth linkage is lost. For robotic total stations, there may be a Radio option

that resembles the Cable option, except that an extensive list of radio types is available.

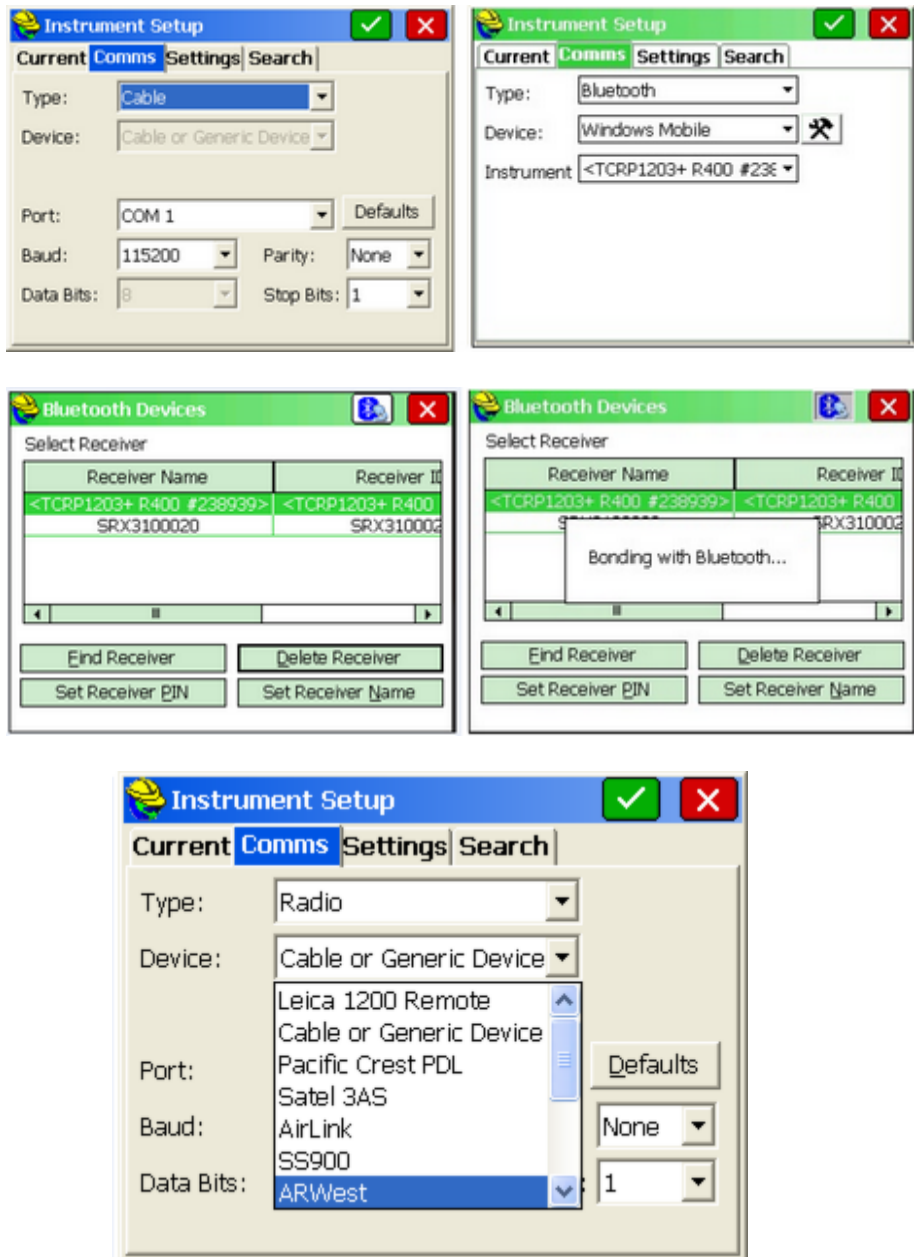

- Port Number:** You must select the COM port to use. This is the COM port of the data collector.

- **Instrument (Bluetooth):** SurvCE can use Bluetooth to communicate only with instruments that have Bluetooth incorporated on them. The Instrument name is displayed when a Bluetooth connection is made.
- **Baud Rate:** Baud rate for data transfer by serial cable or radio.
- **Parity:** Parity setting is None, Odd or Even.
- **Data Bits:** You must select the character length setting.
- **Stop Bits:** You must select the stop bits setting.
- **Defaults:** Clicking Defaults will utilize the standard default settings for the configured instrument.

Bluetooth Wireless

Bluetooth is automatically detected on the Windows Mobile data collector, if available. The com port settings to use Bluetooth vary from unit to unit. For example, Com 3 is typical for the Compaq Ipaq and Com 5 is typical for the Topcon FC1000, though it may use any of Com 4, 5 or 6. On the Allegro, the Bluetooth port is typically Com 4, 5, 8 or 9. The Bluetooth serial com port settings can be found in the “My Bluetooth Device” menu selection.

Settings/Search Tabs

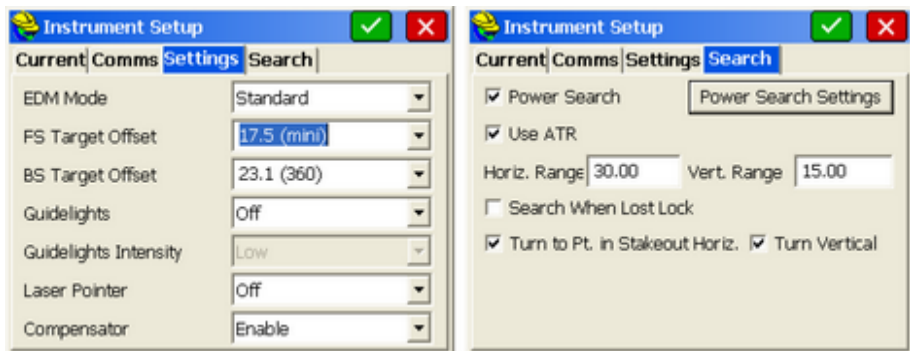

- **EDM Mode:** Options may vary by equipment. On the Leica 1200 total stations, for example, available methods are Standard (1.5 to 2 seconds), Fast, and Reflectorless. Referring to the graphic below, when storing points or staking points, your current mode of operation is displayed on the top line (eg. prism mode, locked on and tracking the target, measuring distances). Clicking the "little man" or distance tracking icon takes the program to the “No Distance” or “Tracking Only Mode” (no distance measurements, locked on and tracking target). Avoiding taking distance measurements will save battery usage. On large topo jobs or as-built surveys, many field surveyors prefer to turn off distance tracking, but leave the instrument locked on the

target for quick measurements. On Leica instruments, this will show a beam or line in the direction of the prism, which will move as you walk between measurements. While locked on and tracking distances (as shown below), the store icon (data collector icon) will always take a “Tracking” shot (last shot in memory), and pressing enter will take a Tracking shot if Enter is configured to Store only (to mimic the store icon). Pressing the read icon (measure icon) will always cause a new, fresh reading to be taken, as will Enter when configured to Read and Store (normal). The figure below shows the Tracking/Distance mode, which follows the movement of the prism by taking distance measurements, much like RTK GPS.

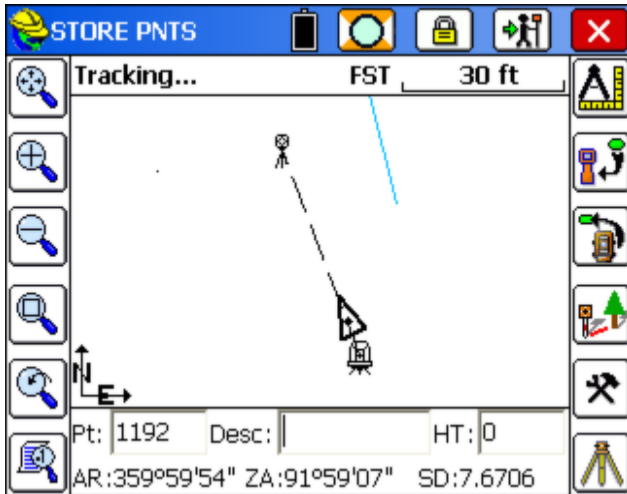

Note that in the above figure we are in “Fast” read mode for a configured reading, and in “Tracking/Distance” mode for display and quick readings by S. Changing to “No Dist” mode leads to display of direction only, as shown in this figure:

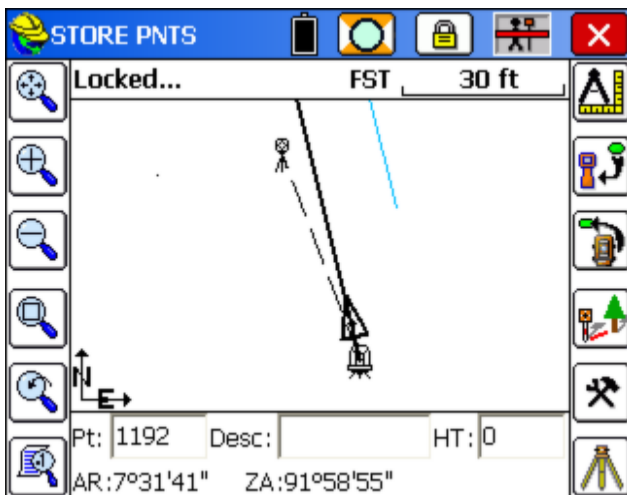

- **Foresight/Backsight Prism Offset:** This drop down menu provides a list of standard prism offsets. Whenever a prism constant is changed, a note is written to the raw (RW5) file. When you select one of the prisms from the list (Circle, Mini, etc), the value that is shown in parenthesis is the actual value sent to the instrument. i.e. 0.0 for Circular, 17.5 for Mini. If you select "30mm" or "40mm", we send - 4.4 and 5.6 respectively (30-34.4 and 40-34.4). The user may also type in any value they choose. In this case, we will send that value exactly, unmodified, to the instrument.
 - (360) (23.1): Prism offset of 23.1 (Leica model).
 - Circle (0.0): Standard Leica round prism.
 - Mini (17.5): Leica mini prism.
 - ReflTape (34.4): Equates to zero offset (wall, surface).
 - 30mm: Other manufactures (Sokkia, Seco).
 - 40mm: Other manufacturers.

- **Guidelights:** When available, guidelights can be turned on or off and their intensity set by the user. They are seen from the prism viewpoint, and are valuable when running robotically from the prism, looking at the instrument. The field surveyor can see when he is lined up with the instrument by the appearance of the guidelights.

- **Laser Pointer:** Ideal for indoor or dark evening surveying, this feature causes the instrument to emit a red beam. It is often used when doing reflectorless work and makes a red mark on the wall, floor or object being surveyed. This is useful for confirming the position prior to the shot. The beam should not be directed into someone's vision or eye.

- **Compensator:** Settings are On or Off.

- **Power Search Enabled:** The Power Search option may be available with motorized total stations. This option activates the "PowerSearch" button in the "banner line" at the top of the survey and stakeout screens. When Power Search is pressed, the total station will typically find the prism in 10 seconds regardless of the direction it is initially pointed. If it has found one prism and you hit "Power Search" again, it will leave that prism and find the next one. If you have only two prisms on the job (foresight and backsight), it will conveniently rotate from the foresight to the backsight and back again each time it is pressed.

- **Use ATR:** When this feature is enabled, ATR (Auto Target Recognition) will be used when configured to standard or fast reading. When running the robotic in remote mode with ATR turned on, and when performing a "Set Angle and Read" in the backsight screen (a standard measured backsight), the ATR connection will be taken into consideration, so that the angle set is relative to the center of the prism, not necessarily the crosshairs of the instrument. The "Set Angle" and "Check Angle" functions will still be relative to the crosshairs. With ATR set on a robotic total station such as a Leica 1200, the prism can be found even if the instrument is not pointed exactly at the prism. The ATR feature is strong enough to shift the instrument onto the exact center of the prism even if sighting slightly outside

the prism circle itself.

- **Horizontal Range/Vertical Range:** This is the range that will be used in a Standard Search. When lock is lost, and the "binoculars" icon appears, tapping the binoculars or "search" icon will conduct a standard search for the prism through the range of horizontal and vertical angles set, based on the current centering of the instrument. This feature applies to all robotic total stations.
- **Power Search or Work Area Settings:** This will define a limiting area for searching. This can speed up both the standard ATR Search and the PowerSearch. The Work area angle ranges apply to both searches. The Show button will show the two positions of the search window, first by moving immediately to Position 1. You will be prompted to press OK to see Position 2. Having defined a "window" of searching, Center will move that window to a new center position. You will be prompted to "Sight on Centered Position and Press OK". The Define button prompts you to shoot the lower left and upper right positions, which are then displayed above under "Work Area". If the Work Area is set to start at 0.0000 horizontal, for example, searching would send the instrument to the backsight point.
- **Search When Lost Lock:** This feature will auto-search whenever a measurement is taken, if the instrument is not currently locked on target.
- **Turn to Point in Stakeout Horizontal/Turn in Vertical:** These options are useful only in stakeout with motorized total stations, and the effect is to turn to where the stakeout point or position is calculated to be. If Turn to Vertical is off and only Turn to Horizontal is on, the instrument will retain the current vertical position of the theodolite.
- **Tracking and Reflectorless:** The upper left of the screen controls the ATR Search, and the upper right controls the PowerSearch. The Work area angle ranges apply to both searches. The Show button will show the two positions of the search window, first by moving immediately to Position 1. You will be prompted to press OK to see Position 2. The Center option will initially take the standard search horizontal and vertical range and center that range around the current position of the instrument, for purposes of searching. However, if you Define a new range (point to a new lower left and upper left position), then Center will use that defined range of motion for any position that is sighted. If the Work Area is set to start at 0.0000 horizontal, for example, searching would send the instrument to the backsight point.

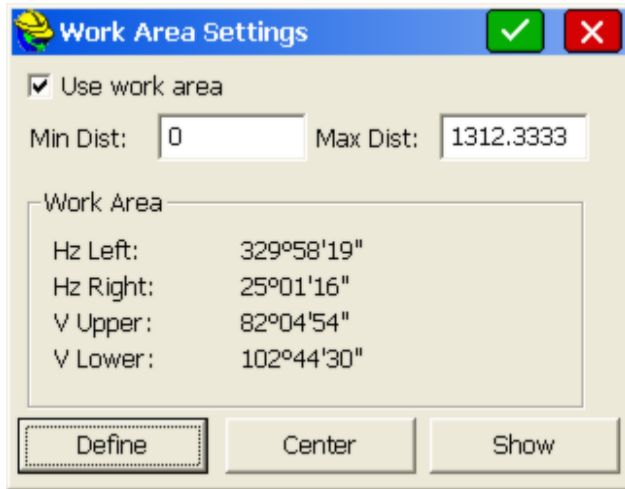

Manufacturer Setup Instructions

For manufacturer specific information, please consult the Instrument Setup by Manufacturer manual portion.

Total Station Prism Search by GPS

This feature utilizes NMEA GPS to help the motorized or robotic total station find the prism. Often the NMEA GPS is the one built into the data collector itself. For example, with the Carlson Mini2 or the Hi-Target Qmini, both of which have built-in L1 GPS, the SurvCE software can access this GPS and guide the instrument to the prism. You can also link to an external GPS like a Garmin 10, if your data collector has no built-in GPS capability. This feature is not designed for full RTK GPS, but only for NMEA or any GPS sending the "GGA" message, which is typical of NMEA GPS. This feature is particularly useful with the Focus 30 robotic total station from Spectra, the Focus 10 (former Geodimeter 600 and Trimble 5600), Topcon and Sokkia robotic total stations, the StonexR9 and even the strongest "Power Search" based robotic total stations all of which in certain situations may be interrupted by leaves, fog, reflective surfaces, even the sun in some cases. With Prism Search by GPS, the instrument turns in the direction of the GPS position and can often sight close enough to allow target recognition features to take over and locate the prism.

Grid Coordinates and Local Coordinates: There are 3 ways for the feature to work:

- (1) Fully automatic if the job is on grid coordinates as defined in Job Settings, System Tab.
- (2) Fully automatic if the job is on local coordinates and a GPS localization file is referenced.
- (3) Functional after 3 points due to an internal localization and improving in accuracy until 20 total station field points are measured, after which the program statistically uses the "best" 20 points and removes outliers. Any new point is

checked to see if it improves the localization by comparing total station and GPS distances. You can also block the program from considering new points for a tighter localization (such as to avoid points near canopy). The localization for Prism Search by GPS can be stored and re-used in subsequent days.

In the graphic below, GPS Search, using the NMEA GGA message built into the Mini2 data collector, can be used to find the prism if there are many interfering reflecting objects in the vicinity.



Total Station turns to GPS position of data collector. Align collector with prism for most accurate results.

The features are found within the Search Tab for any robotic total station driver.

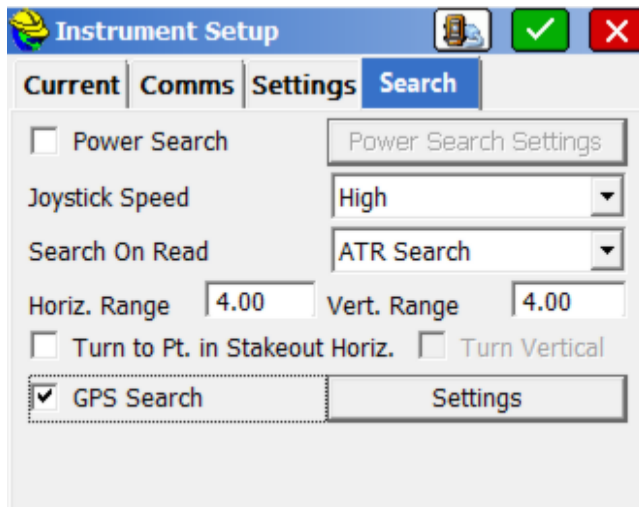

For any robotic or motorized total station, the Search tab will contain the GPS Search option. Select this and then choose Settings:

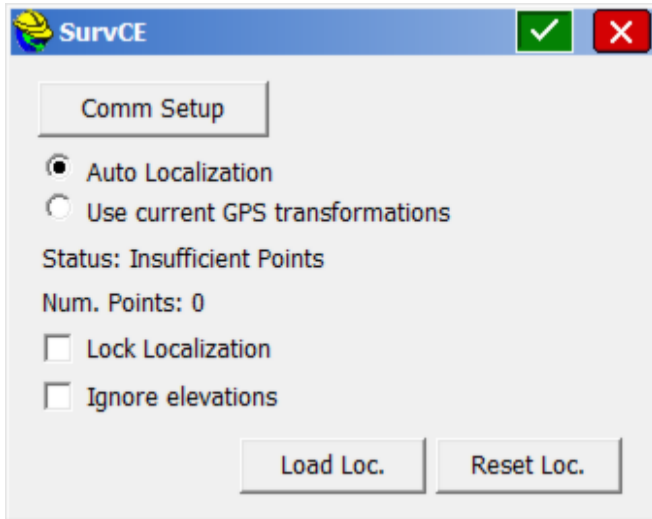

The Settings dialog shows the 3 methods of GPS Search. Method 1 is Auto Localization which uses the measured field points "on-the-fly". This is the 3rd method mentioned above, the internal localization. If you have less than 3 field measurements with total station and GPS data in common, Status will indicate "Insufficient Points". If you use Auto Localization from field measurement points, you can lock the localization and not use additional points for the calculation. You can also Ignore Elevations.

If you set "Use Current GPS Transformations", you have 2 options, to work with a loaded localization file or to use no localization file and use only the direct grid coordinates for the selected projection as configured in Job Settings, System Any specified Geoid file will also be used in locating the prism from the GPS reading.

The Comm Setup option refers to the communication with your handheld data collector to obtain the NMEA GPS position. The Mini2, for example, can communicate through Com 8 at 115,200 baud based on an internal connection. You select "Cable" but it is using an internal cable to the motherboard. Clicking the GPS icon at the top of the dialog will verify the connection.

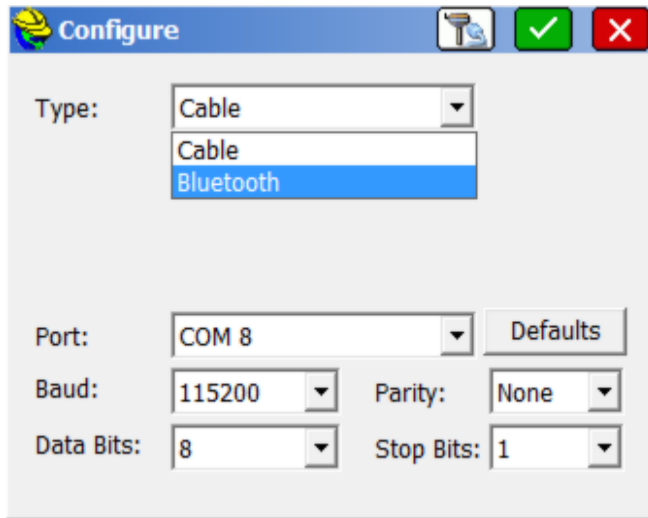

It should be noted that you can also use a completely external separate GPS unit for the NMEA message and link to that unit with your data collector (which may lack the GPS NMEA feature). For example, a little Garmin 10 GPS can be the source of the NMEA GPS position, linked by Bluetooth to your field data collector.

GPS Setup

Both Base and Rover GPS are configured with Receiver and RTK in the same manner. Base GPS requires additional setup and is covered in the GPS Base section. GPS Rovers section covers the configuration of GPS networks and internet corrections. This section covers the common portion of the process, selecting the GPS equipment doing basic configuration. In the dialog below, it is recommended to work left to right across the menu structure. Here are two examples (Altus and Ashtech, near the top of the alphabet). The recommended procedure is to work left to right across the tab items, from Current to RTK and then within tab options, verify the items from top to bottom. Note that configurations, including settings in Comms, Receiver and RTK tabs, can be given names, saved and recalled using the Load option.

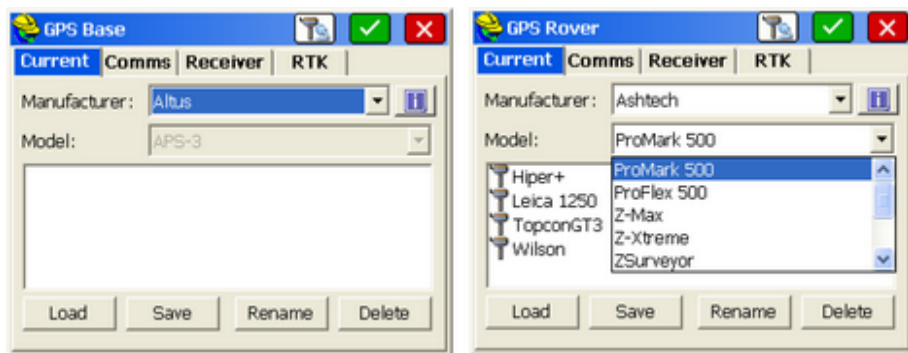

Current Tab

Select first the manufacturer and then the model for the GPS equipment to be used. Do this distinctly in the GPS Base and GPS Rover command if different brands and models of GPS equipment are used.

Comms Tab

Typical connection is by cable, but in more recent GPS models, Bluetooth connection is available, for example, with Ashtech ZMax, ProMark 500, ProFlex 500, Topcon Hiper and GR3, Altus APS-3 and other models. The Bluetooth Com port comes from the data collector and can be any number from 3 to over 40. In a few cases such as the Ashtech ZMax, the Bluetooth Com port should be set to the baud rate in Comms Setup to match the baud rate set for Port C on the ZMax receiver which is typically used for Bluetooth communication. For Topcon, set the baud rate in Comm Setup to match the baud rate for Port B on the Hiper receiver, which is typically used for Bluetooth.

Find Receiver

Clicking the tools icon next to the right of Device proceeds to the Bluetooth Manager screen. This screen gives you the option to choose which GPS receiver you would like to connect to via Bluetooth. If you click Cancel, no Bluetooth connection will be established. Select a receiver and click the Bluetooth icon at the top of the screen, to connect.

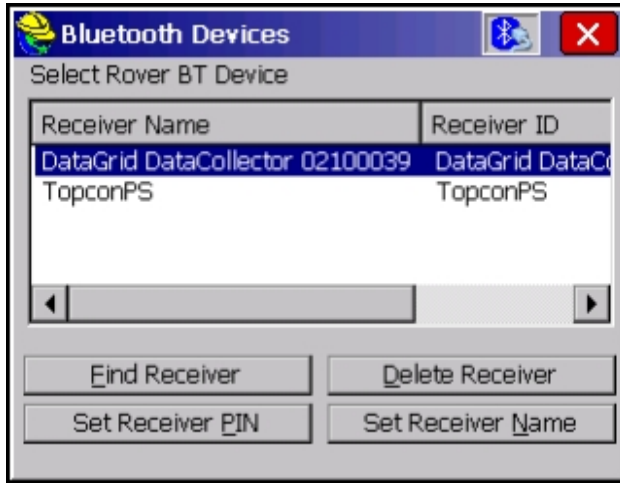

First time into this routine, no receivers will be listed. Select Find Receiver and you can add the connected receiver to the list. (You may also find ALL Bluetooth devices in the vicinity, which may include cell phones and computers. Find Receiver will “ghost” if. Find Receiver will only work on ARM processor devices, which includes the Allegro and Symbol 8100.

On the Allegro CX and on data collectors with the Socket Bluetooth driver, a search window appears as shown below:

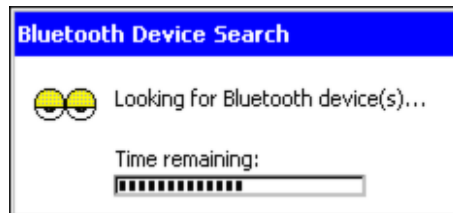

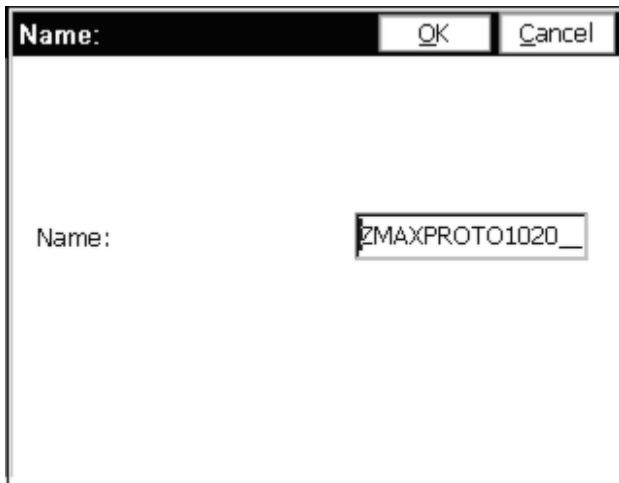
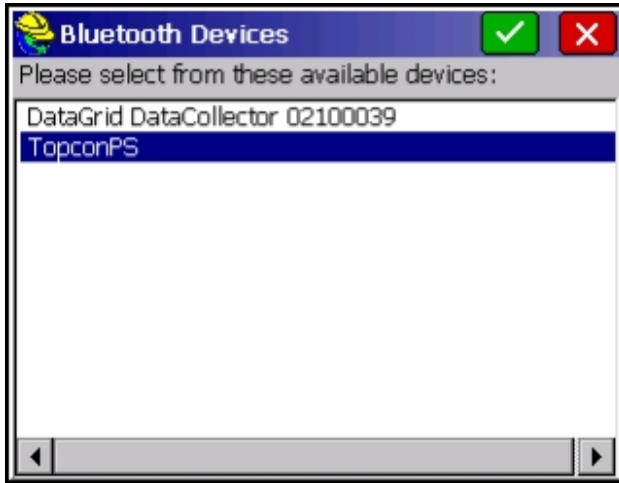

Delete Receiver

Highlight a Bluetooth Receiver and click Delete Receiver button to remove the device. You will be prompted before removing the device.

Set Receiver PIN

You can enter the receiver PIN by clicking “Set Receiver PIN”, and you can change the receiver name by clicking “Set Receiver Name”.

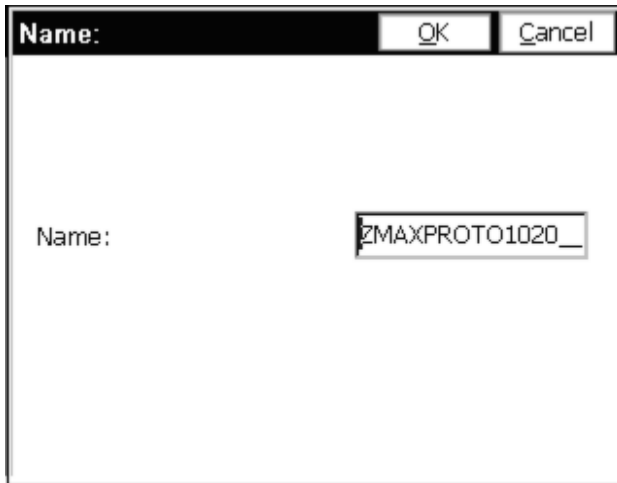

The default PIN is different for each manufacturer and examples for PINs are below. Please see your equipment manuals for your equipment PINs.

Topcon	11111
Leica	00000
Thales	12345

Bluetooth Manager

The Bluetooth Manager will appear in many places: entry into the program, clicking OK from Comm Setup, Configure Base, and Configure Rover (it works the same from all of them). After making a successful connection, the software will let the user know. If the connection fails, there will be a warning.

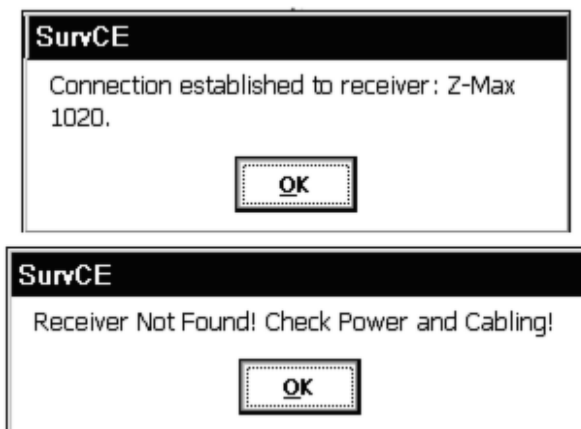

Trouble-shooting Note: Be sure the GPS receiver is turned on before trying to connect, and that you are within 30 feet of the receiver. If the user can't see the

device from the Bluetooth Devices program, it is not going to work in SurvCE. The Bluetooth Manager works somewhat better with a passkey but it is not strictly necessary. Sometimes the Bluetooth registry settings don't work correctly with an empty passkey. A pass key is the name the Bluetooth driver uses for a password. This is always used on Thales/Ashtech and can be used on Topcon. It makes the Bluetooth connection more reliable.

Receiver Tab

This tab is used to Configure the receivers Antenna, set the elevation mask and for some gps position rates.

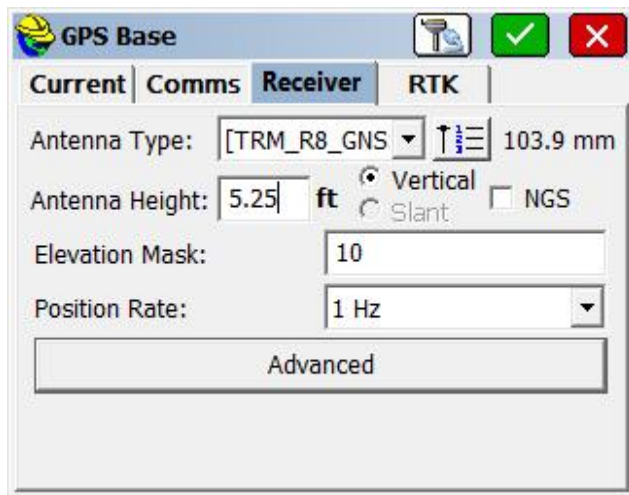

- **Receiver Model:** SurvCE will auto-detect the receiver model and display it in this list. It will also auto-detect the port setting for data and the port baud.
- **Antenna Type:** The entire list of supported antennas is available for selection. To select an antenna press the "List" button and search the list by manufacturer. In this dialog, the user can also verify the antenna offset values or create custom antenna types.
- **Antenna Height:** Entered as either "vertical" or "slant" height in the current job units. The slant height is the distance from the base of the pole or from the "hub and tack" up to a mark or defined slant measurement point on the edge of the antenna (See NGS for more details). The vertical height is measured plumb, straight down from the base (where it screws into the antenna) of the antenna to the ground.
- **Use Internal Antenna:** Many GPS units now have internal antennas. Select this option if not using an external antenna.
- **Elevation Mask:** This specifies the cutoff vertical angle above the horizon. Any satellites below this angle will be left out of calculations.
- **Position Update Rate:** This option allows the user to set the position update rate for the GPS readings. 1 Hz will display one reading per second, while 5 Hz is 5 times per second.

RTK Tab

The RTK tab is used to configure the GPS RTK communications.

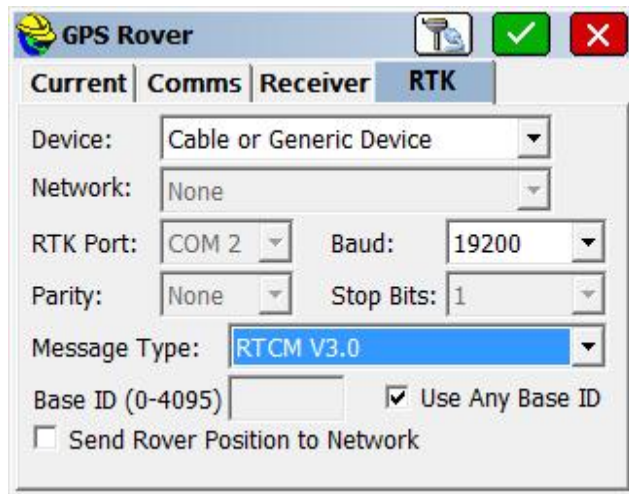

The screenshot shows the 'RTK' tab in the 'GPS Rover' software. The window title is 'GPS Rover' and it has standard Windows window controls (minimize, maximize, close). The 'RTK' tab is selected, and the 'Receiver' tab is also visible. The configuration fields are as follows:

- Device:** Cable or Generic Device (dropdown)
- Network:** None (dropdown)
- RTK Port:** COM 2 (dropdown)
- Baud:** 19200 (dropdown)
- Parity:** None (dropdown)
- Stop Bits:** 1 (dropdown)
- Message Type:** RTCM V3.0 (dropdown)
- Base ID (0-4095):** (text input)
- Use Any Base ID
- Send Rover Position to Network

- **Device:** This list contains the supported devices that deliver or receive RTK messages, such as a radio or IP modem. If an External Radio is selected, the user will need to specify the Port, Baud, Parity and Stop Bits that the radio manufacturer requires. For internal radios, SurvCE will detect the proper settings.
- **Network:** This list allows you to configure and connect to various networks (e.g. NTRIP).
- **Message Type:** You must select the RTK message type that you wish to broadcast and receive. This is the format of the RTK message that is either sent from the base and received by the rover.
- **Base ID:** This is typically used to isolate paired devices. The user specifies that the base is "ID 1", then the rover should be set to only listen for "ID 1" so that other base stations that might be in the area do not interfere.
- **Send Rover Position to Network:** This will output a NMEA GGA message for networks that require it.

Manufacturer Setup Instructions

For manufacturer specific information, please consult with the Instrument Setup by Manufacturer section.

GPS Base

For GPS equipment, it is necessary to set up the base antenna and record the correct antenna height, the antenna type (for certain equipment), and the methods used for localizing (obtaining the desired coordinates).

Much of GPS Base is common to most instruments. For example, the Base Ant. Height would be entered in feet or meters, depending on the setting specified in Units within Job Settings. Vertical or Slant height refers to the method used to measure the height of the base antenna. Vertical refers to the distance from the ground point to the antenna disk, measured plumb. Slant refers to the distance from the edge of the antenna disk down to the ground point directly beneath the center of the antenna. Elevation Mask refers to the degrees above the horizon above which satellites will be used for GPS “correction” calculations, and below which satellites will be ignored. Keep in mind that it is not always better to lower the elevation mask below 10 or 15 degrees. Satellites closer to the horizon than 10 degrees will often degrade the calculation of coordinates.

The “alternative” to GPS Base is GPS Rover. GPS receivers can usually function as either type, but must be “configured” for the role they will serve. You will be warned when you switch receiver configuration from Base to Rover and vice versa, to confirm that is what is intended.

With all RTK GPS Equipment selections (except GPS Simulation), GPS Base will first bring up settings and then proceed to the 6-option GPS Base screen which “locates” the base position.

After completing the GPS communications setup and clicking on the Ok button the Base Configure dialog will be presented. These button options "locates" the base position. The 6-button GPS Base options (3 buttons per “tab”), common to all, are discussed first, followed by equipment-specific settings.

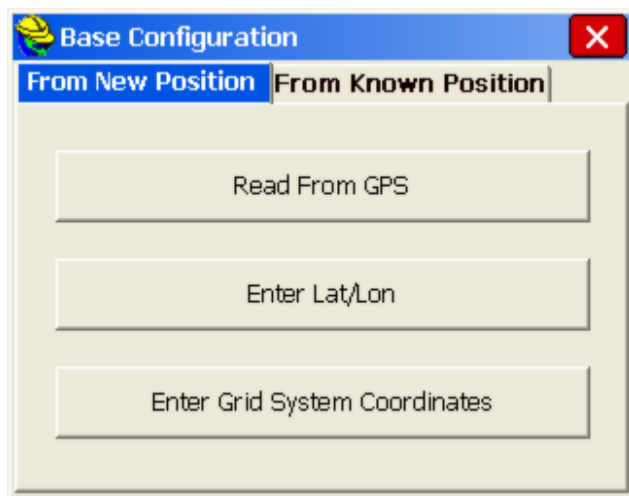

GPS Base for All RTK GPS Brands

For all brands of GPS, the GPS Base button is the command that configures the base receiver for broadcasting GPS corrections to the rover. You must click the GPS Base button in while you are connected to the base receiver. The base needs a set of coordinates to use as its stationary position. Given that you are configured for a particular coordinate system, there are 2 main “types” of localizations: (1) Enter an Accurate Base Position and work from that point outward on the scale

and “true north” of that system (no rover localization), (2) Enter an Accurate or Semi-Accurate (Read from GPS) Base Position and then localize to known rover points that transform to the local coordinate system (required if the local system is not true GPS north). There is also a “mixed” base-rover approach. To use the base in the localization, you should configure the base with the "Use Local Coordinates" option under "From Known Position". Here, you configure the base by entering the local point (5000, 5000,100) and start a new localization file (or use an existing one if it applies). Then, at your rover, you can add more points to the localization as necessary. In this case, a single rover point within Localization will produce a scale factor and best fit to the local coordinates.

There are six methods to set the stationary base position, organized into 2 categories: From New Position includes Read from GPS, Enter Lat/Long and Enter Grid System Coordinates. The From Known Position tab includes Previously Surveyed Point, Use Local Coordinates and Read From File. When you are starting a new job (no information in the raw RW5 file yet), always use the options in From New Position.

From New Position Options

- **Read from GPS** - This method takes a specified number of GPS readings from the base receiver’s autonomous position and uses it as its “true” position. The autonomous position can be off of the actual position by 150 feet. The base will calculate corrections based on this autonomous position. If you set up the base with this method, the rover points must be used for localization since the corrections they are using are based on the approximate position of the base antenna. Read GPS, combined with rover-based localization, is one of the most common methods used to start a GPS survey. When Read from GPS is used, the program will present the current position, as shown:

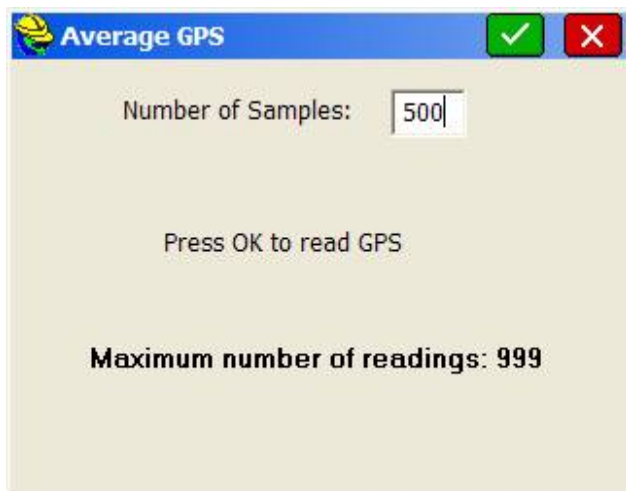

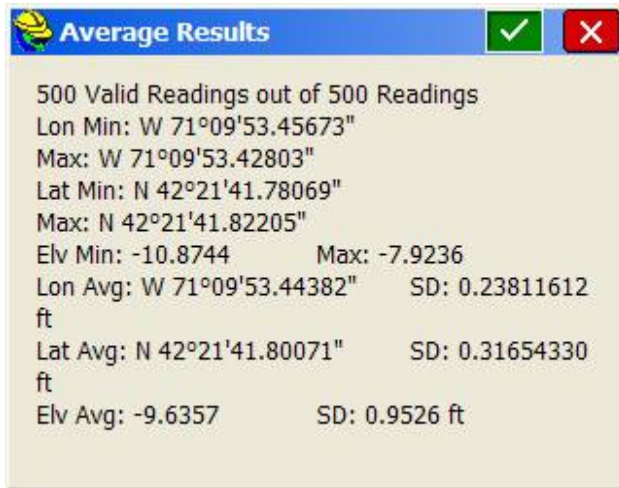

Latitude: N 42d21'28.35882"
Longitude: W 71d08'12.87540"
Elevation: 116.376

Continue with Base Setup?
Yes No

If you like the result, press Yes and continue on. You will then be prompted for the Reference Station Number. This is an “ID” that will store to the raw file and permit post-processing of the raw GPS data. A typical entry is 0001. The final prompt will say,

Base Configuration Successful. Save Settings to File?
Yes No

Answering Yes will bring up an entry screen for the reference file name. Reference files are stored with a “.ref” extension. It is important to save a reference file if you plan to return to the job at another date. Without re-localizing to control points, you can set up over the same base position, recall the reference file, and enter the new antenna height for the base position, and start working.

The Read from GPS option is sometimes referred to as “Find Me”. This option is accurate to about 10 to 50 meters, typically, and it enables the corrections to broadcast with enough accuracy to permit localization and sub-centimeter real-time work. Be sure that your GPS zone in Job Settings is set correctly before using this option. Also, give the base enough time to find itself. When first set up, the base receiver has to “collect” satellites and “resolve ambiguities”. If you Read from GPS too early, you may find a position, but one that is not fully resolved and ends up slowing down the speed at which the rover fixes.

- **Enter Lat/Lon** - Requires you to enter the latitude and longitude for the

position of the base antenna. This is useful if you are setting up over a monument whose latitude and longitude is known. It can also be used over a control point whose position is known from GPS post-processing. This will put you on the NAD83, NAD27, UTM or other coordinate system specified in Job Settings, GPS Tab. You can still do a rover-based alignment to transform to a local system. Rover-based localizations are always improved by more accurate base positioning. If the GPS detects that your entered Lat/Long is not near the current GPS readings, the program will warn the user.

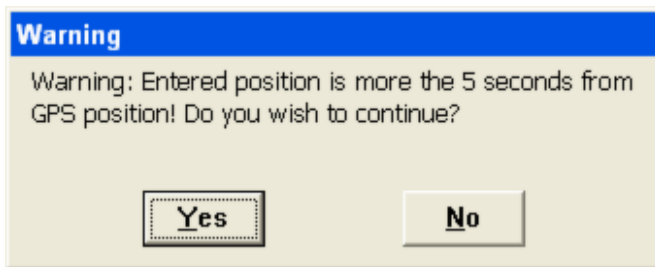

This method should be used if you are reasonably sure of the accuracy of the latitude and longitude—it should be at least as accurate as the “Read from GPS” option, or otherwise you will have difficulty getting a “fix” on the rover. If it is a very accurate latitude and longitude, you will get the best results. Pressing OK leads to the option of store the base position as a reference file, similar to Read from GPS.

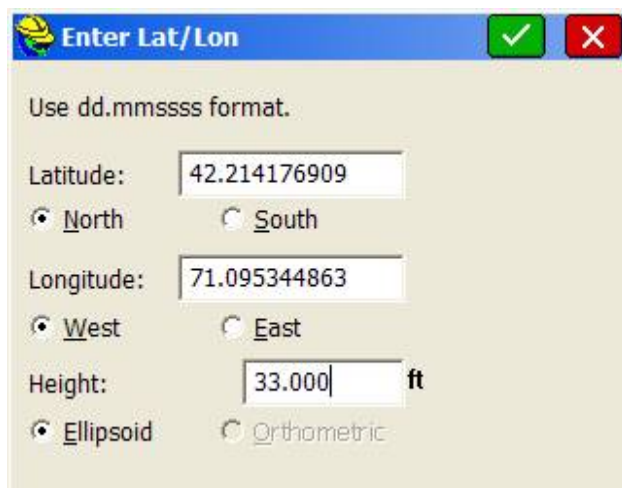

- **Enter Grid System Coordinates:** Requires you to enter the grid system northing and easting for the point that the base is occupying. This applies to any projection that you have configured, including U.S. state plane, worldwide UTM or any individual country or user-defined grid system. This is useful if you are setting up over a monument whose coordinates you know.

An accurate base position, either by entry of Lat/Long or Grid System Coordinates, will enable immediate data collection without rover-based localization, but also will improve rover-based localization.

The Coordinate method is similar to the Lat/Lon method, since Lat/Longs convert to Grid Coordinates based on the current coordinate system set in Job Settings, GPS option. The Grid Coordinates will convert back to the Lat/Long coordinates needed by SurvCE to configure the base.

Grid Coordinate

Point From File: 3

Current Zone is MA Mainland

Northing: 2957456.307632 ft

Easting: 752940.944011 ft

Elevation: 323.095472 ft

Ellipsoid Orthometric

Base Configuration

From New Position From Known Position

Previously Surveyed Point

Use Local Coordinates

Read From File

From Known Position Options

- **Previously Surveyed Point:** This requires you to enter the coordinates, on the configured coordinate system, of a known, surveyed point. This will transform and localize to the local coordinate system, and optionally can be followed by rover-based localization. The known point must be found in the RW5 file in a form that includes its Lat/Long (a previous GPS measurement).

This Lat/Long, just as with New Position options, is used to establish the base position. This method requires that you are working within an existing job that has a raw file including Lat/Long positions for the points being used. This next figure is an example of the prompting.

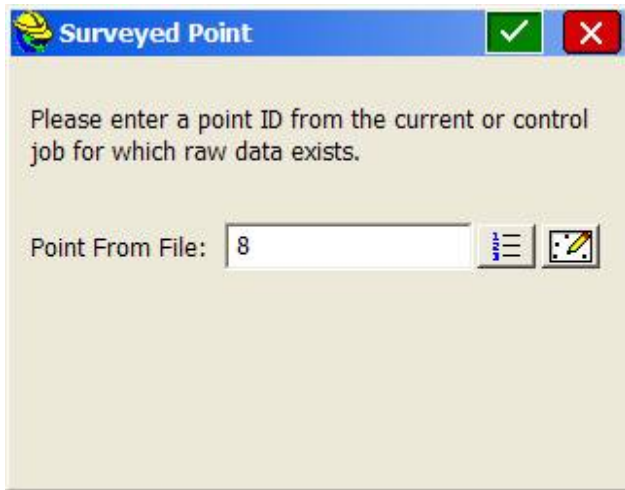

Like the other options, this continues on by showing the corresponding Lat/Long for the coordinate and allowing the user to save the result in a reference file.

- **Use Local Coordinates:** If you have “localized” using option 5 (Localization) within the Equip menu, you obtain a “dat” file. This localization file is used to convert any Lat/Long reading into a local coordinate. By the same token, you can take a local coordinate, run it back through the dat file and obtain a Lat/Long for the base receiver setup. That is the procedure used in this option.

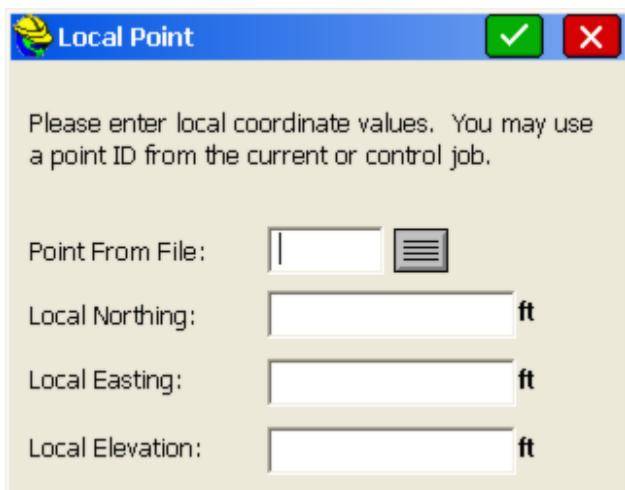

When OK is pressed, you will be asked to load the associated “.dat” file, in a dialog similar to below:

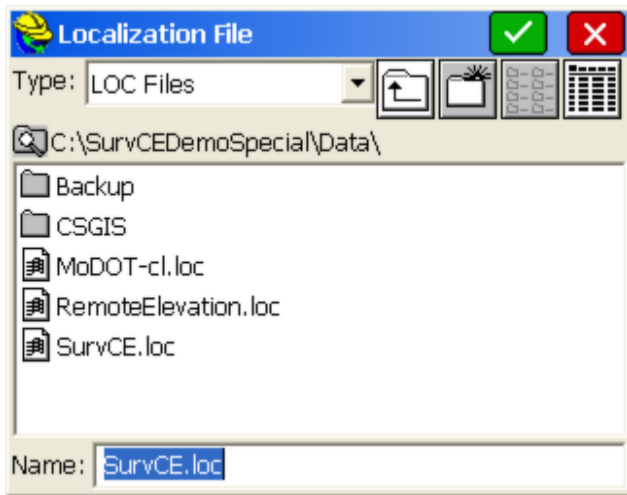

- **Read From File** - Reads a previously saved base position file. All of the other methods of setting up the base let you save the base position at the end of setup. If you return to a site, set up the base in exactly the same position, use Read From File to use the same base position and you don't have to re-align the rover: the old alignment is still valid.

This option recalls a reference file in a dialog similar to that above. Then you will receive the standard prompting.

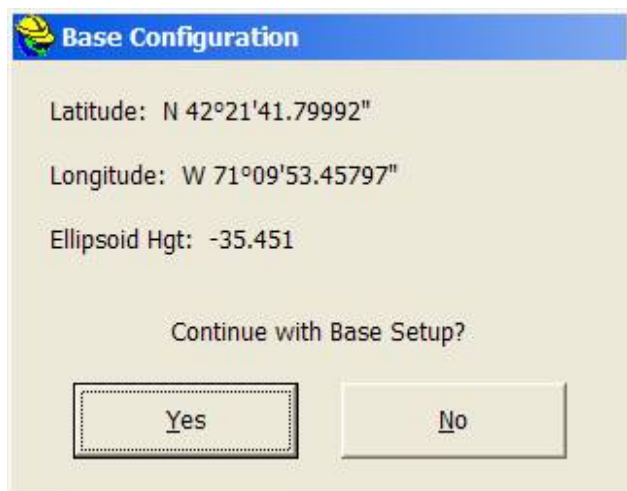

This is followed by the Reference Station ID prompt (showing the default ID). The “new” base antenna height, which will change with each new set up, is entered back at the first set of dialogs. A message is displayed after

successful configuration from a file. Only if you set the base antenna on the same horizontal and vertical position each day would the base antenna height remain fixed. If the base antenna height and x,y position is the same from day to day, then you do not need to do GPS Base each day. You would simply power up the base, power up the rover and start working in that case. Keep in mind that in certain power surge conditions, receivers can lose their settings, and a re-configuration may be necessary, even if the base receiver antenna has not been moved.

Note: In SurvCE 1.50.006 or later, a “quick connect” is performed when you exit and re-enter the SurvCE program. In earlier versions of SurvCE (before August 20, 2004) and after the release of SurvCE 1.50 in May, 2004, it was necessary to conduct a fresh GPS Base after exiting SurvCE.

Note: One method of obtaining Latitude/Longitude and state plane coordinates in the U.S. is to occupy a point, any point, for two hours or more, logging the static data, then submit the Rinex file to the NGS “OPUS” program accessible on the web. You must log the data with dual frequency equipment. The OPUS program is fully automated, and will return the xy,z, lat, long, ellipsoidal height and orthometric height. This data can then be entered in during base localization. Though most post-processing programs (Trimble Geomatics Office, Leica SKI-Pro) use proprietary post-processing file formats, they will output the ASCII “Rinex” format needed by OPUS.

GPS Rover

For many brands of GPS, receiver perform differently depending on whether they are set as base or rover. Even though the receivers are identical, they perform differently depending on whether they are configured as a base or a rover. Multiple rover receivers can communicate with a single base receiver. The GPS Rover command is used to set the rover receiver to the correct parameters and to instruct the receiver that it is, in fact, a rover.

Connecting a GPS Rover to a Modem or Base Network

There are several methods for connecting to an available network. The RTK tab in the GPS Rover dialog configures the modems and network settings.

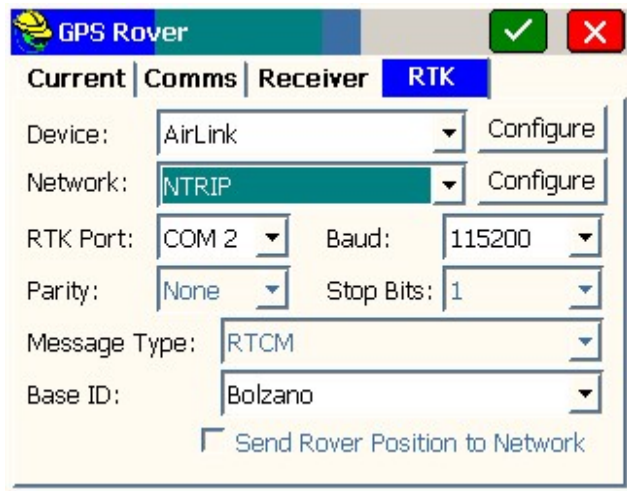

The dialog is designed to be filled out from the top to bottom, and from left to right. First select the device you will use to connect to the remote modem or network.

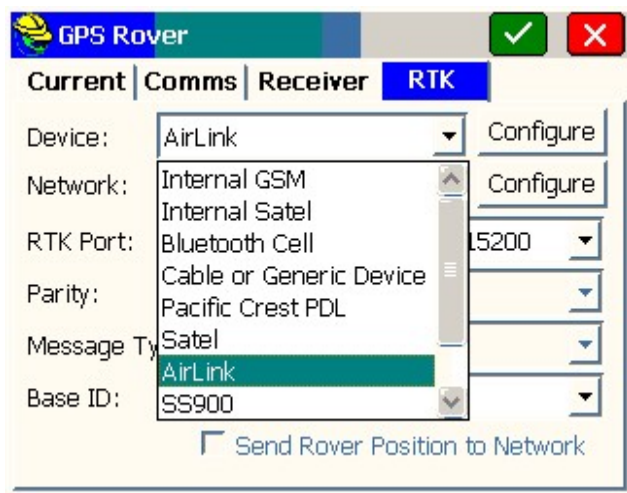

If a particular receiver model supports an internal modem or radio, meaning it is integrated into the receiver; those devices are shown first in the list. When an internal device is shown in the list, it means that model could have the device inside, but does not guarantee it. The user will have to know if the receiver was purchased with an integrated radio or modem.

External radios and modems are shown next and then one of the last options is “Data Collector Internet”, which is a special case explained below where the data collector provides access to the internet instead of a modem inside the receiver or connected to the receiver..

Once a device that is capable of connecting to the internet is selected, the Network combo box is enabled. Select the type of network connection you will use.

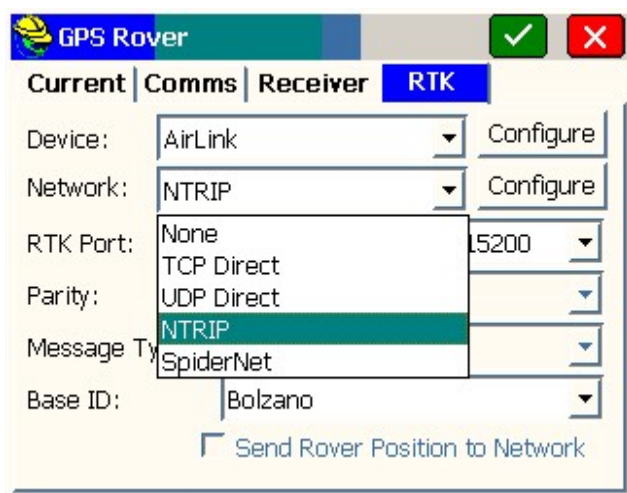

Here is a brief summary of the different network types available:

TCP Direct: For connecting to a single modem at a base or to a VRS network or another network that doesn't require a special login. The configure button for TCP Direct brings up this window:

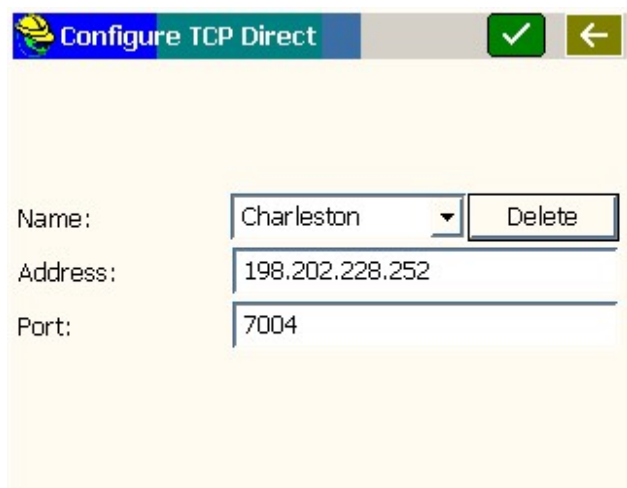

To add a new base or network address, select <New> in the Name field and replace the "<New>" text with what you want to call the connection and fill out the Address and Port fields. Most modems support either an IP address (Ex: 192.202.228.252) or a URL address (Ex: www.basenetWORK.com).

UDP Direct: This works exactly like the TCP Direct option but uses UDP protocol instead of TCP. Most networks use TCP.

NTRIP: This option is for base networks that support NTRIP protocol. Pressing the Configure button shows the NTRIP Broadcasters (Also called Casters) that have been previously connected to.

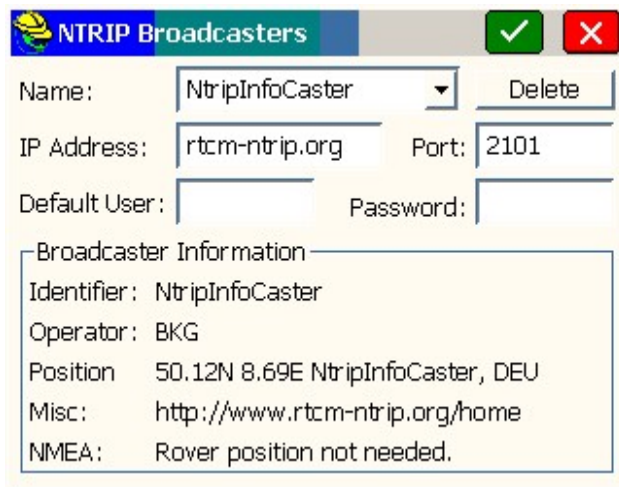

The default is for rtcm-ntrip.org which if connected to will download information about many Broadcasters (casters) all over the world. They will be shown the next time NTRIP Configure is selected. Select an existing caster or select <New> in the Name combo box and replace with a different name and fill out the other information. If the Default User and Password fields are filled out, they will be used as the default user name and password for all the bases at that caster.

When the green checkbox is selected, SurvCE will have the modem connect to the address of the Broadcaster and establish a connection. The Broadcaster then supplies a table of bases (also known as mountpoints) available at that Broadcaster. SurvCE puts the table of bases into the next window that comes up.

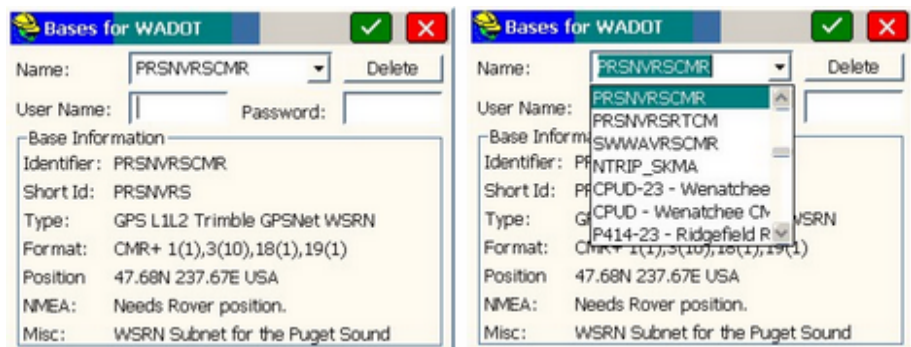

If you don't like the name of the base supplied by the Broadcaster, you can change it to something else you prefer and SurvCE will remember your preference but still ask the Broadcaster for the correct base.

Select the base you want to use and press the green check box. You are brought back to the RTK tab with the base you selected as the current Base ID. You can change the Base ID in the RTK tab without going back to the NTRIP Configure button.

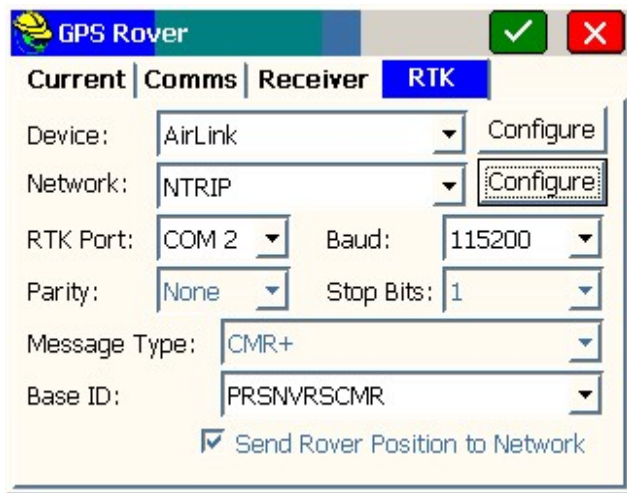

Note that with NTRIP, SurvCE already knows if the base wants the rover position sent and what type of corrections are being sent. Those settings are shown in the RTK tab and are grayed out to guarantee that they stay on the correct setting.

SpiderNet: Networks that require that a GPUID message be sent to the network should use the SpiderNet option. The SpiderNet Configure window comes up when the Configure button to the right of the SpiderNet option is pressed.

Add a new network by selecting <New> in the Name combo box and typing in the name of the network and filling out the other fields. If the User Name and Password fields are left empty, the GPUID message is not sent to the network.

Just like when using a radio, the RTK Port combo box is to identify which port on the receiver should be configured to accept RTK corrections. The Baud, Parity, and Stop Bits combo boxes specify the settings for the RTK port. Message Type identifies what type of RTK correction message the receiver should be expecting.

Base ID when using a network is a combo box to select the name of the network or base the modem should connect to. Use the Network Configure button to change the bases available in this list.

“Send Rover Position to Network” if turned on will cause the receiver to periodically send GGA messages out of the RTK port to the base or network.

Connecting a Data Collector to the Internet

There are several ways of connecting a data collector to the internet – Cell phone cards inserted into the data collector, connections to a cell phone with a data plan, etc. These instructions assume that an internet connection has already been established to the data collector. One way to tell that the data collector is connected to the internet is to browse the internet using Internet Explorer. For information about how to connect a data collector to the internet using an Enfora cell card in an Explorer 600+, search Carlson Knowledge Base for “Enfora”.

Once the connection to the internet has been established, start SurvCE and select Configure Rover in the Equip tab.

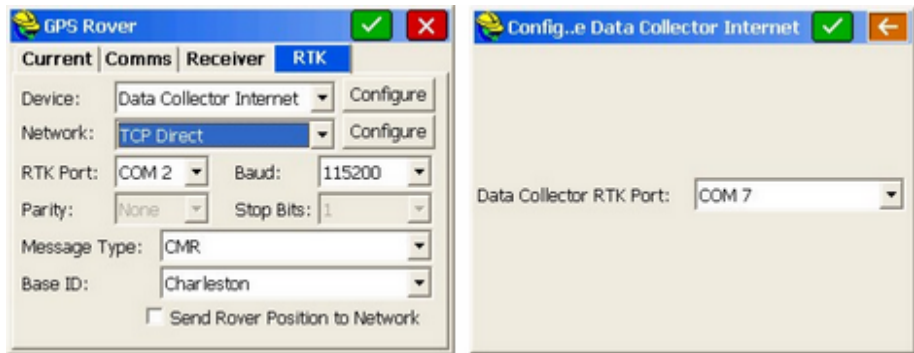

Press the Configure button to the right of the Data Collector Internet option. Select the COM port on the data collector that is connected to the RTK port of the GPS rover receiver. It cannot be the same port that is used to control the receiver and is selected in the GPS Rover Comms tab. It may be a serial port or a BT port with a connection that has already been established.

After selecting the port and pressing the green check to accept the input, select the network type in the RTK tab. Other settings are just like using the other modem selections as explained in the section “Connecting a GPS Rover to a Modem or Base Network”.

RTCM3.1 Message String (for automated Grid Position and Geoid Adjustments)

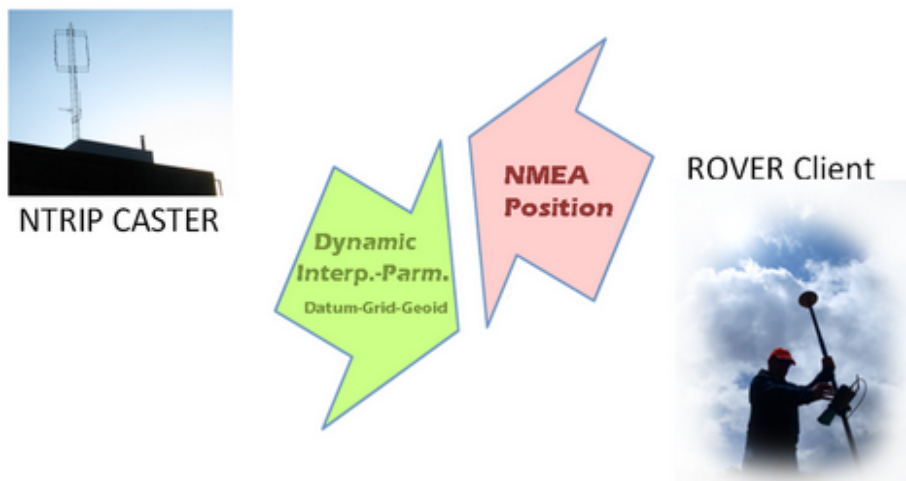

Certain NTRIP casters (virtual reference systems) send out the RTCM 3.1 message format. A subset of these casters will send out the 1021 to 1027 messages within the RTCM 3.1 formatted messages. When these 1021 to 1027 messages are available, they contain grid system adjustments, sometimes for the x,y position, and sometimes additionally for the geoidal separation or "Z" elevation adjustment. When these added messages are parsed and applied to the

x,y,z position of the RTK reading, greater accuracy is obtained.

Germany, Austria and Croatia are countries where NTRIP casters adopted the RTCM 3.1 message format very early, and included the 1021-1027 message strings for x,y and z adjustments. The example below shows the sequence of operations to capture this message string as broadcast in the Bavarian region of southern Germany. First, confirm you have the correct grid system set. It is recommended not to rely fully on the RTCM 3.1 1021-1027 information for the grid source, but have the correct grid zone loaded within SurvCE itself (Job Settings, System or Localization, System tab).

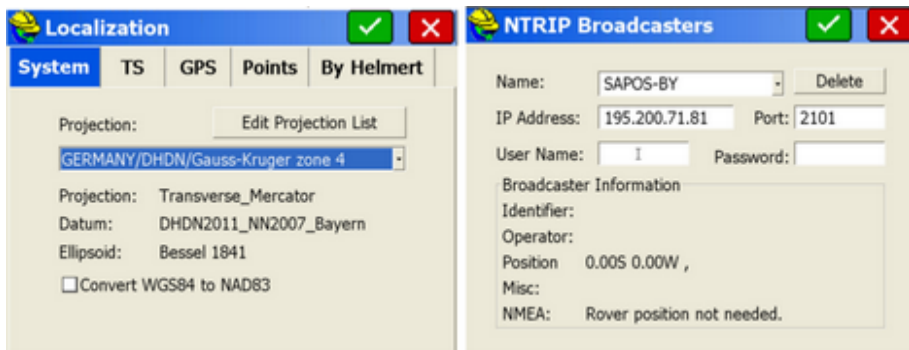

Now go to GPS Rover, RTK tab, select NTRIP for the Network, and click Configure to the right of the NTRIP option. Then load the correct network and IP Address and also enter your user name and password. The network selected above was an early adopter of RTCM 3.1 messages containing the 1021-1027 message strings. Usually you pay for access to most NTRIP service providers to obtain a user name and password.

Then when you click OK, back in the RTK tab, pick Tools/Configure opposite the Sapos-By Ntrip network, and choose the appropriate mount point table or "base" that broadcasts the RTCM 3.1 message string, as confirmed in the dialog below: Note that the format is RTCM 3.1.

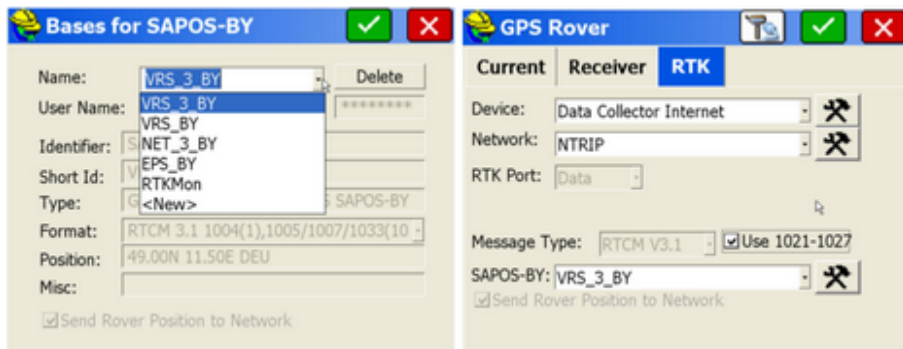

If the caster provides the RTCM 3.1 message string for 1021 to 1027, then the option "Use 1021-2017" appears. Check this on. Not every provider that offers

RTCM 3.1 will support the 1021-1027 messages.

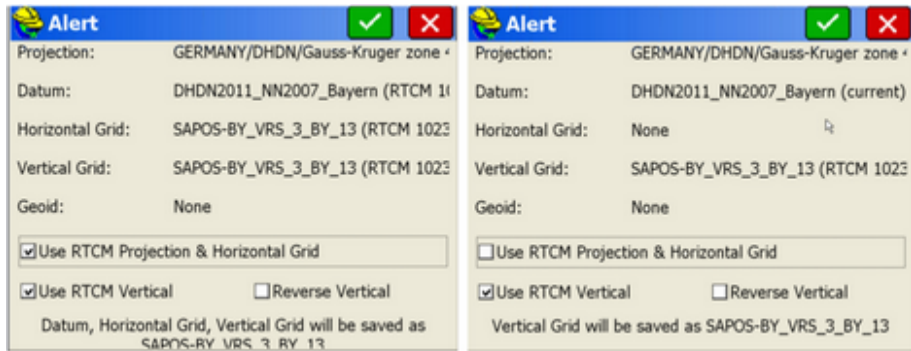

When you continue, you see this Alert screen which allows you to use selected portions of the available adjustments within the 1021-1027 message string. For example, you can choose to use both the horizontal and vertical adjustments or just the vertical to obtain the geoidal shift automatically. The "Reverse Vertical" is a rare option that applied, at least at one time, to a caster that reversed the sign on the geoidal shift. Rather than adding the geoidal shift, it would subtract it. Also note that if you turn off the horizontal grid adjustment, then the program would revert to your Job Settings, System tab setting for the grid zone, which is why setting that zone initially is important. Where 1021-1027 message data is loaded and imported by the above method, it is referenced in the software in other commands. For example, using another German NTRIP mount point as shown below, the 1021-1027 data are imported directly into the geoid file selection and Position tab information in Monitor/Skyplot.

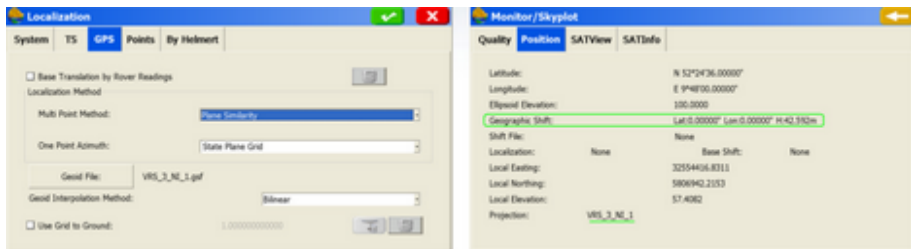

Here is another example of use of the RTCM 3.1 1021-1027 message string applying to Croatia:

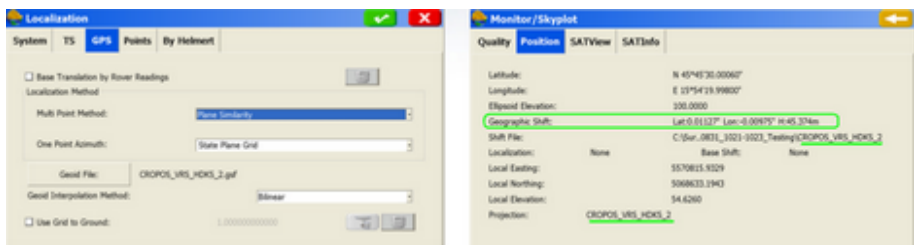
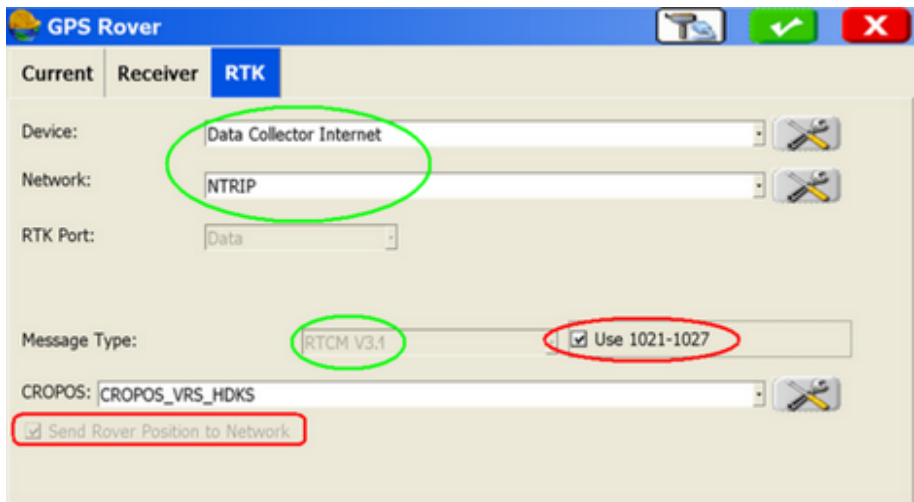

Current implementation in SurvCE is based in a new RTCM decoder that is compatible with the following RTK methods and devices:

- Any GNSS receiver compatible with SurvCE DCI (Data Collector Internet) RTK method. This mean for those able to make an NTRIP connection using a network device in the Data Collector, like internal GPRS modem, Ethernet, WiFi, etc
- Using the Internal GSM Modem in ALTUS APS 3 or PENTAX SMT888 (both on v2 versions) GNSS rover receivers
- Using the Internal GSM modem in Stonex S8 and S9III receivers

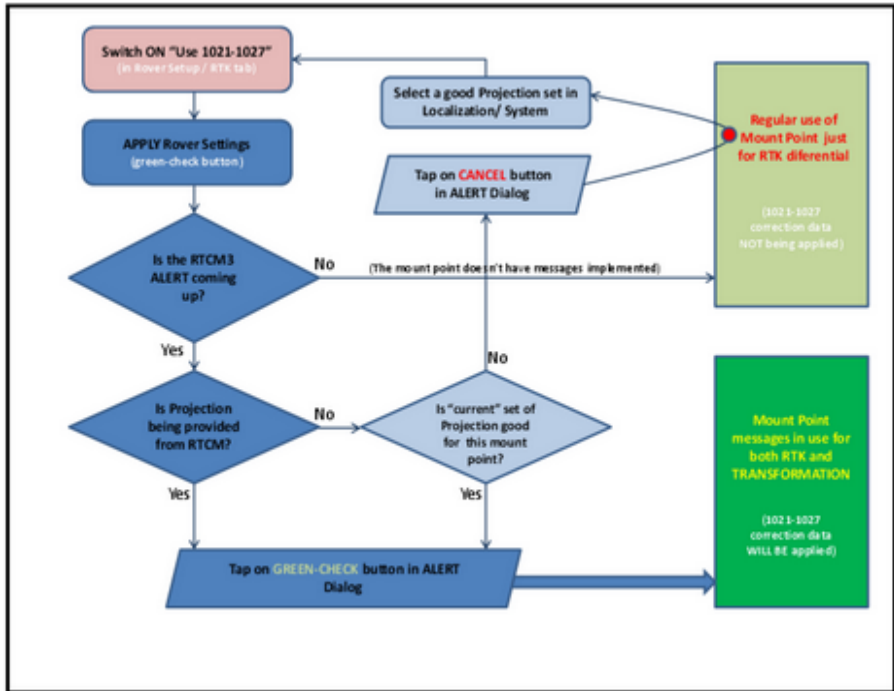

GPS Utilities

Every GPS manufacturer and model has a different set of GPS Utilities. The primary purpose of the Receiver Utilities is reset and/or troubleshoot the GPS receiver.

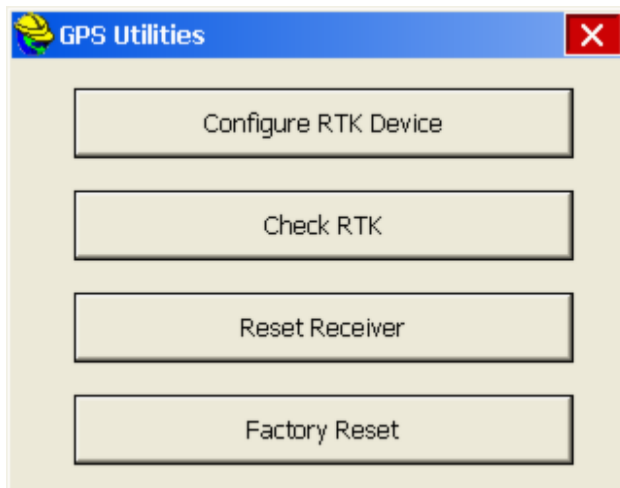

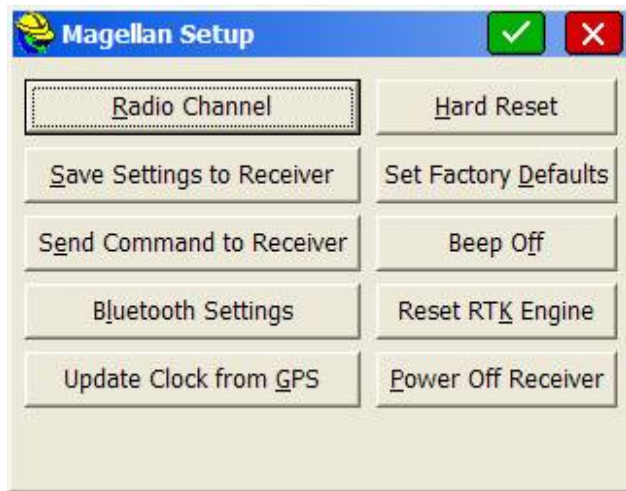

Common GPS Utilities

- **Reset Receiver:** This command performs a soft reset of the GPS receiver. Soft resets will reinitialize the receiver like a power cycle. Soft reset does not delete the memory.
- **Factory Reset or Hard Reset:** This command will erase the memory of the receiver and restore the setting to a factory settings.
- **Power Off Receiver:** This will power down the receiver.
- **Save Settings to Receiver:** Stores receiver settings to internal memory.
- **Beep Off:** Turns off the receiver alarms.
- **Radio Channel:** Change the channel radio channel of the GPS.
- **Configure RTK Device:** Use this page to change your RTK data port settings. This can also be done during base or rover configuration.
- **Check RTK:** This tells the user why they aren't in RTK fixed.
- **Send Command to Receiver:** You can send what are known as “push” commands, internal Thales/Ashtech codes, to the receiver. This should be done only in consultation with your Thales dealer.
- **Reset RTK Engine:** This resets the carrier phase ambiguities. This is a useful command if you are having difficulty obtaining lock and want to start the process of fixing over again. Receiver settings are retained (so you can think of it as a “soft reset”).
- **Bluetooth Settings:** The Bluetooth settings in SurvCEs Bluetooth Manager (discussed in Comm Setup) do not actually change anything in the receiver itself. In order to make changes to the receiver's internal Bluetooth settings, it is necessary to go into Receiver Utilities and click on Bluetooth Settings.

GPS Utility for GPS Simulation

If running GPS simulation, the starting point can be reset using the special GPS utility. Enter the new Lat/Lon for the position.

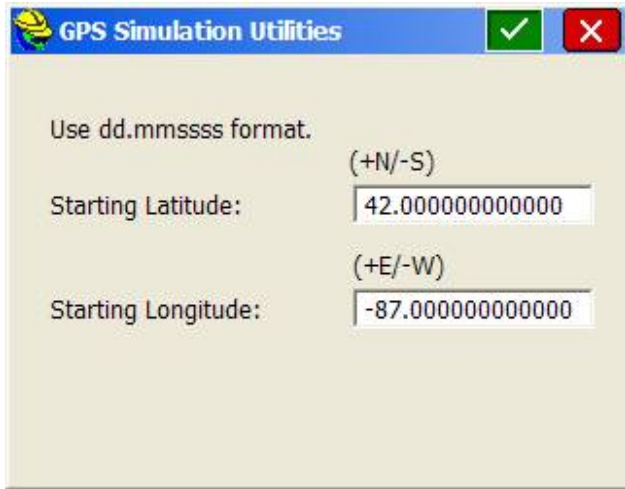

GPS Utilities by Manufacturer Setup

Manufacturer specific information is available in the GPS Utilities by Manufacturer section.

Configure (General)

This tab allows you to select settings and preferences that apply to observations taken in the field. These options remain set from job to job. If an option is not applicable, it is grayed out. Configure is accessible from within any routine where the **C** or **Configure** Icon is present. These options can also be accessed by pressing ALT-C on the keyboard.

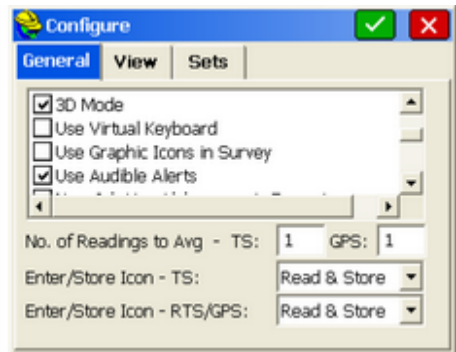
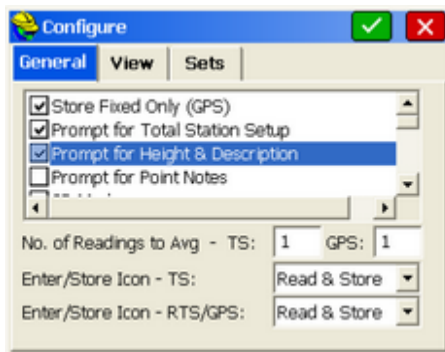

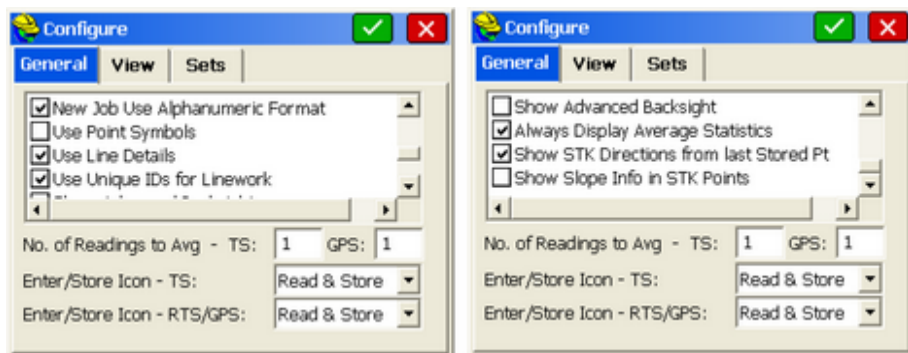

- **Store Fixed Only:** When enabled, only data gathered in the fixed (locked) status will be stored to the point file. If you attempt to store data when the receiver is not fixed, a message will appear stating, "Position is not fixed! Continue storing?" The program will prompt to store the point anyway. This allows for overwriting the **Store Fixed Only** option without having to go back to the **Configure** menu.
- **Prompt for Total Station Setup:** This option determines whether or not the software will display the current setup and orientation values each time the user enters a survey routine.
- **Prompt for Height and Description:** When this option is enabled, you will be prompted after each shot to enter the target height and description. Though this adds an extra prompt screen to each shot, it can reduce errors, as you no longer have to anticipate the shot and get the correct information entered ahead of time. This prompt screen is shown in the figure below. Two additional icons, for tangent curves ("AFIT") and elevation only ("ZO") appear on a third screen. The elevation only option will allow use of a line code such as "EP" for elevation only but will not draw linework through that point. The triple dot icon in the lower right cycles through the icon options, all of which can be entered by hand. When this screen appears, you will have the option to enter a point description and change the point number and the target height. Note that all the field codes identified in the Feature Code List under File are available for touch or arrow key selection, provided this option is activated in **Job Settings** (Use Code Table for Descriptions). Also, if you enter the first character of a code (for example, "I" for IP), the first field code starting with that character will be highlighted, allowing you to arrow key to the one you want, or accept the highlighted option. This entry is not case-sensitive. Disable the **Prompt For Height and Description** option to save time while storing points, or if you are certain that your height and description will not change from shot to shot. If the option is disabled, you must be sure that the correct target height and description have already been entered.

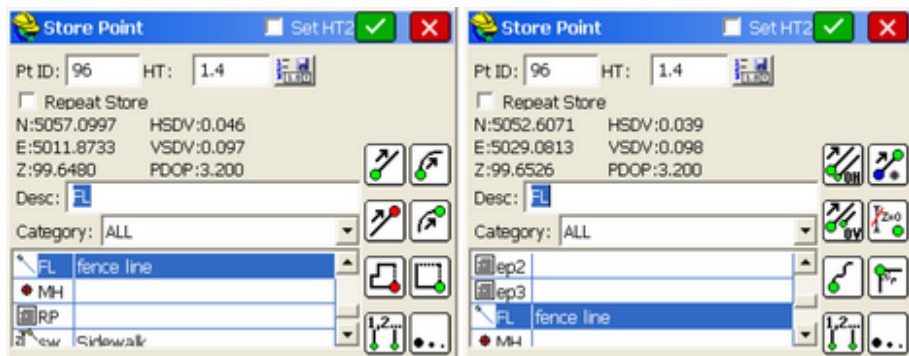

Regarding heights, the  icon will toggle between the current height of measurement (eg. prism height, antenna height) and a list of previously stored heights. It is useful when switching between commonly used heights such as full pole extension and normal setting.

Note: In the Height/Description Prompt screen, you will see pre-defined Feature Code points indicated with a large dot. 2D polylines will show as a simple line, 3D polylines will show as a line with a "Z" indicator, and descriptions entered that are not found in the feature code list will appear with the "fieldbook" symbol above.

- **Prompt for Point Notes:** Point Notes are additional descriptions that can be stored with a point. A regular point consists of a point ID (number or alphanumeric), northing, easting, elevation, and description (up to 256 characters). Point Notes are a way to add an unlimited number of lines of text to a point. With this toggle enabled, you will be prompted for notes after collecting a point. The notes are stored in a file with the same name as the coordinate file, but with a .NOT extension. For example, a job called TOPO.CRD would have a note file called TOPO.NOT.
- **3D Mode:** This option allows you to toggle between 2D or 3D data. In 2D mode, all elevations will be stored as 0.0 and there are fewer prompts on many screens such as the backsight screen (no instrument height and target heights).
- **Use Virtual Keyboard:** This option provides a software keyboard for data collectors without keyboards.
- **Use Graphic Icons:** This option toggles between the traditional letter icons (in versions prior to SurvCE 2.0) and the graphic icons for options like Store Points and Offset. Specifically for Portrait View, it also organizes the main 5-tab menu items into icons so there is no scrolling of the main menu (see contrasting views below). Although the Store Points screen icons appear immediately when this option is on, the main menu icons in portrait view appear only after re-starting the program.

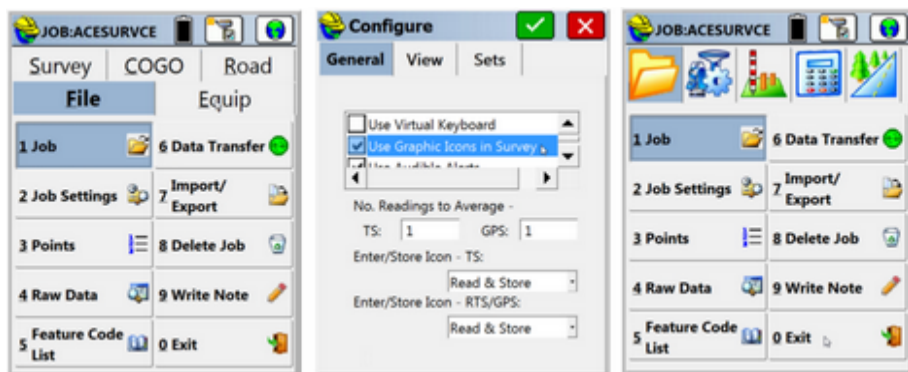

- **Use Audible Alerts:** Turn on or off data collector sound alarms.
- **New Job Use Alphanumeric Format:** When this option is enabled, SurvCE will allow alphanumeric point numbers such as 2A or T1105. When this option is disabled, SurvCE will only allow numeric point number entry. **Note** : this setting only affects new jobs, not existing ones. Using purely numeric files can increase operation speed in very large files, however, this option limits points to just over 32,000. An alphanumeric format will be necessary for files larger than 32,000 points. A comment will be added in the Rw5 file “—CRD: Alphanumeric” or “—CRD:Numeric”, based on the format used.
- **Show Continuous Total Station Angles:** This allows you to display angles continuously within SurvCE. This option appears and only applies when using total stations including On-board versions of SurvCE.
- **Use Point Symbols:** When turned on, point symbols established for point-based codes in the Feature Code List command will draw on the screen. The value of this option is to distinguish features visually while working in the field, and the symbols stay in the dxf file and can be exported to a .dwg file. Shown below is a tree symbol defined by the code "dt" for "deciduous tree". Point do not have to have defined symbols in the Feature Code List, so even when clicked on, points can still plot without symbols.

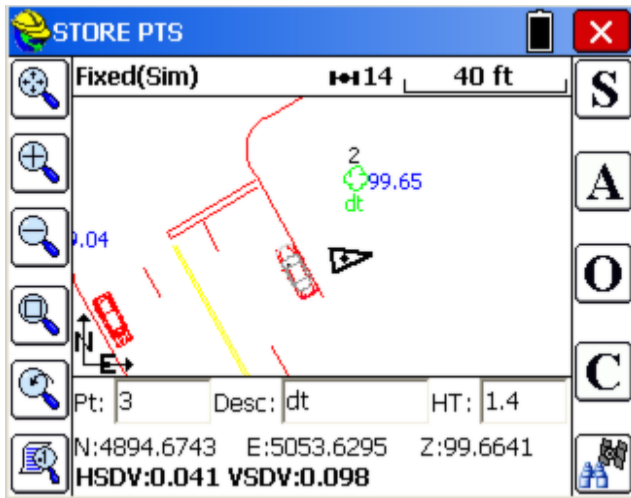

- Use Line Details:** This option has 2 effects. First, when clicked on, linework will "auto-draw" any time a feature code is changed or new points with codes are added to an existing point list. Secondly, the option enables selecting of lines (by clicking on them), leading to options to edit the line, extend the line, or create new lines emanating from the vertice near the clicked point.

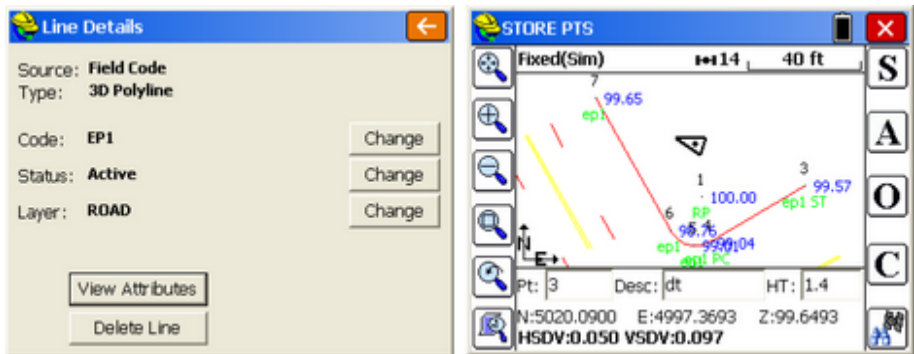

Reviewing the line from 3 through the curve from 4 to 6 and then to 7, this line can be clicked within the map screen without issuing any command, and the Line Details screen will appear at left. If you tap too close to a point ID, then Point Details will appear. But you can also click lines within the command Store Points. This provides additional options to Extend the Line and draw a New Line from the nearest vertice to the picked point. These options are discussed in detail in the section on Feature Code List found in the File menu.

- Use Unique IDs for Linework:** This will impact the meaning of the "Start Line" special code, which is also appended using the green circle icon shown



here: When clicked on, then start line will not only append the start line code (such as "ST") to the feature code, but will increment the code

number by 1, as in EP2 ST. If the last line was EP2, then using the start line icon on another EP would create a code EP3 ST. In this way, there is no need for an end line code, since each distinct EP has its own numeric identifier (as in EP1, EP2, EP3).

- Attach Photographs to Points/Lines:** This feature appears when the program detects a data collector operating system capable of using an external camera or built-in camera, such as with certain Getac, Hi-Target, Flint, the Nautiz X7 used with Navcom GNSS and other models. In Portrait mode, the option appears as shown below. Also turn on Height/Description Prompt in Configuration to use the Camera feature. Then when field measurements are taken by GNSS, total station or other means, you can tap the camera icon within the Height/Description prompt screen (middle below). Then you can select an image that is stored anywhere on the field data collector, or you can click "Capture" and take a photo. The images are associated with the point or line, and more than one image can be attached. Each individual image can be given a description. If multiple photographs are associated, you can tap the right arrow to move through the gallery of photos and their associated descriptions. You can Remove any if desired. Any single Photo can be Changed to better match the description (or removed and added again).

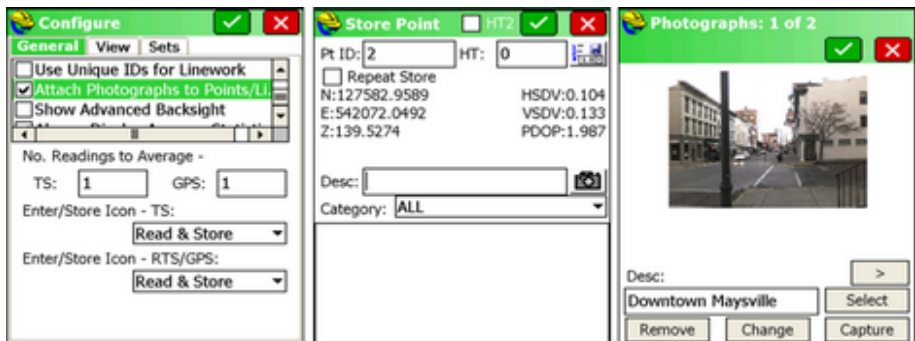

When adding photos by "Select" or by "Capture", the Next and Prev buttons will appear in Landscape mode when more than 1 picture is attached.

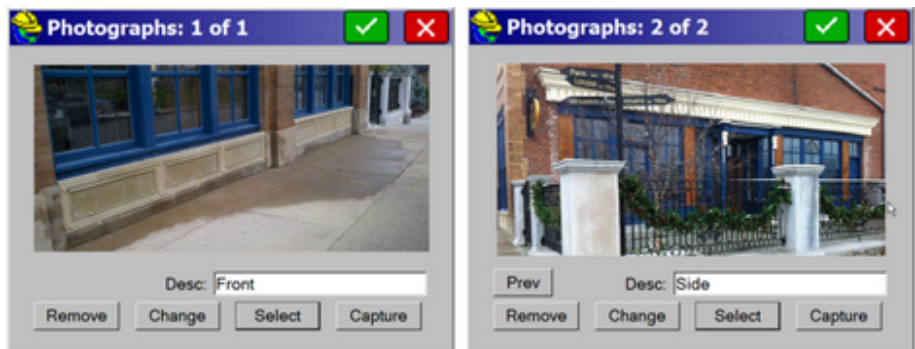

The Camera feature, when activated here, also appears both in Line

Details (when clicking a Line) and within Input-Edit GIS Data in Map, Tools menu.



In these commands, you can review photos and continue to Capture, Select, Change or Remove photos associated with the selected entities.

- Show Advanced Backsight:** This option applies to total station work and allows for multiple reference backsight points, each one of which can be sighted and measured multiple times. Then, based on least squares analysis, the program will compute a "best fit" backsight for purposes of zeroing the total station. The command can be likened to a special Resection for purposes of zeroing the instrument (or setting it to a backsight azimuth). This is a more commonly used in Europe. You can still obtain very accurate backsights to a single backsight point using direct and reverse methods, so most surveyors do not turn on this feature. The feature has some built-in error checking to prevent improper calculation if the coordinates for the backsight reference points are not correct or in proper relation to each other.
- Always Display Average Statistics:** This option defaults on the "Always Display Average Statistics" option within Store Points, A for Average. An example of this average statistics display for a sample of 10 GPS readings appears here:

Average Results		
Valid Readings:	10/10	
Fixed:	10/10	
	Average	StdDev
Eas:	4922.641	0.0173 ft
Nor:	4917.789	0.0172 ft
Elv:	99.654	0.0081 ft
	Min	Max
Eas:	4922.616	4922.666
Nor:	4917.760	4917.814

- **Show STK Directions from Last Stored Point:** Directions to the new point to stake will be in reference to the last stored point using the Point List option.
- **Show Slope Info in Stake Points:** This option will display slope information from your current reading to the target point to stake.
- **No. of Readings to Avg (TS & GPS):** Specifies the number of readings that will be taken and averaged on each observation. Values between 1 and 9 are accepted for Total Stations and 1-999 for GPS. If the tolerance is exceeded between readings, a warning screen will appear.

Note: The Num Dist Readings setting does not apply to Manual Total Station mode. In this mode, you can use the **Calculator** to average distances. When prompted for Slope Distance, enter “?” to bring up the calculator. Choose the Scientific Tab. Follow the tutorial below to average three values:

141.213 Enter
141.211 Enter
141.220 Enter

Now press + on the keyboard twice and with the first +, 141.220 is added to 141.211 to get 282.431, then with the second + you get 423.6440.

Then enter **3** and type “/”(backslash) for divide. This gives the result: 141.2147.

Choose the **Copy** button at the bottom of the screen, then **Paste** at the top.

- **Enter/Store Icon (TS & RTS/GPS):** Since the **Enter** key is a convenient and popular way to take shots in the **Store Points** command, SurvCE allows you to specify the effects of this key. These different functions of the **Enter** key apply not only to **Store Points** but also to **Elevation Difference**. The function of the **Enter** key is set separately for Total Stations and GPS. The different options are described below. **Note:** Most users choose Read then Store.

Store Then Read: This option similar to the effects of the Read key on the original SDR data collectors. After a backsight, the first time **Enter** is used, it will take the shot and display the results. Then when you foresight the next point, Enter will “Store Last, Read Next”. This procedure is best used with the above **Hgt/Desc Prompt on Save** disabled. If that option is on, then when you turn to the new shot and press Enter, the new shot doesn’t take right away, but instead, you are prompted for the target height and description of the previous shot. That could cause some confusion. But with Hgt/Desc Prompt turned off, this method can be very efficient. You press Enter and take your first shot. You see the results displayed, and can alter descriptions or target heights

or point numbers for that shot. You sight your next foresight, and press Enter and the previous shot is correctly stored and the next is taken. The information is displayed. You can review and alter it. You sight your next foresight, press Enter and store the last shot and shoot the next, etc.

Read then Store: With this option, the **Enter** key takes the shot and stores the point. This option works very well with the **Hgt/Desc Prompt on Save** turned on, in which case **Enter** key takes the shot, then displays the results and provides an opportunity for editing as in the Store Point dialog shown above.

Read or Store: The first **Enter** key takes the reading and the second **Enter** key stores the reading.

Configure (View Pt)

These settings control the reporting appearance of the stakeout navigation information. The **Method** setting allows you to choose the stakeout information that is most appropriate for your situation and personal preference. The options for **Method** are described in detail below.

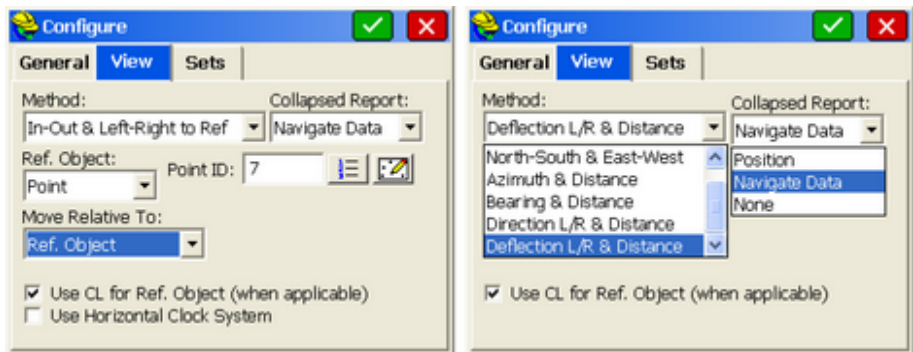

Method Options:

- In-Out, Left-Right:** Nearly all surveyors choose this method with total stations, with instrument as reference object. Set to Reference Object as Instrument, if you are staking a point located 100 meters from the instrument, and take a measurement at 97 meters, the program will respond, "Out 3". If the **In-Out, Left-Right** method is selected, then the **Ref. Object** and **Move Relative to:** options become available to further define left-right. Although "Instrument" is the normal reference with a total station, the **Ref. Object** box allows you to choose a stationary point by which the directions will be referenced. This point can be either the instrument or a known point. If Ref. Object is set as instrument, then left is defined as left of the line between the instrument and the rod. Likewise, if Ref. Object is point then left is defined as left of the line between the point and the rod. The second option, **Move Relative to:**, allows you to decide whether the directions are relative to the stationary point selected in **Ref. Object** or to the moving Rod.

- **North-South, East-West:** When total stations are used, the direction to go in stakeout can be North-South, East-West. For instance, the program might advise, "North 3.582, East 1.917." This method is better suited to GPS work and is subject to having a sense, in the field, of the north direction.
- **Direction to Point—Azimuth, Distance:** This directs you to the point for stakeout by the total distance and the azimuth, in either the 360 degree circle or a 400 degree circle if configured to grads.
- **Direction to Point—Bearing & Distance:** Similar to Azimuth and Distance except bearings referenced from North and South are used for the direction.
- **Direction L/R & Distance:** Available only in GPS mode, you are advised "Right", "Left" or "On-Line" as you move to the target point, along with a distance update.
- **Deflection L/R & Distance:** Available only in GPS mode, you are given precise advice in terms of the deflection angle left or right to turn, as you are walking, to move to the target point. Both Direction L/R and Deflection L/R (shown below) use the recent vector of your movement to determine the correction L/R instruction. Navigate mode in Store Points (an option made available in Job Settings) defaults to Deflection L/R & Distance.

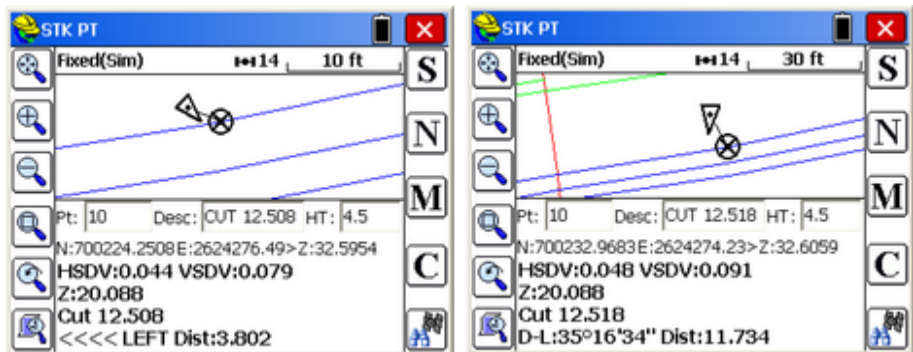

- **CL In-Out, Forward-Back if Alignment available:** This option overrides the settings above, and if the stakeout involves a centerline, the program will direct the user by distance in to or out from the centerline and forward or back along the centerline. Note in the graphic below that the Method is set to North-South & East-West, but the actual report is "Out" and "Forward" because "Use CL for Ref. Object" is clicked on.
- **The Use Horizontal Clock system** option converts the 360 (or 400) circle into a 12-hour circle with 60 minutes per hour, and is used in certain military applications. North is 12 o'clock.

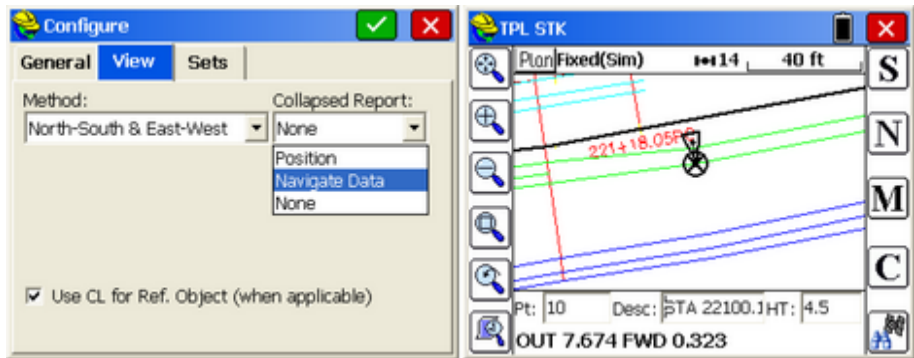

- Collapsed Report** in the upper right of the View Tab of Configure applies to the various Stakeout commands and has 3 options: Position, Navigate Data and None. This option allows for more screen space in stakeout. Shown above is the most popular setting, Navigate Data. When the down arrow is tapped in the field, the multiple lines of stakeout data (up to 6 as shown above) will collapse down to 1 or 2 lines. The "None" setting shows only one line, the next Point line with Description and Height. The "Navigate Data" setting also shows the stakeout instruction (above right). The Position option shows the x,y,z position of the target point and also the next Point line. Pressing the up arrow restores the larger screen. Using a PCDemo version of the software, F2 collapses the screen and F3 expands the screen. With a PC or field data collector, it is also possible to tap and hold the lower graphic horizontal line and drag down to collapse the text and enlarge the graphics, but since tap and hold also pans the screen, the sensitivity of this procedure makes it hard to use--you must tap and drag down just a few pixels of lower graphic window, precisely. It is easier to use the up and down arrow keys, which are more convenient.

Configure (Sets)

This tab allows the user to define how the software will handle angle sets, reciprocals, and direct and reverse.

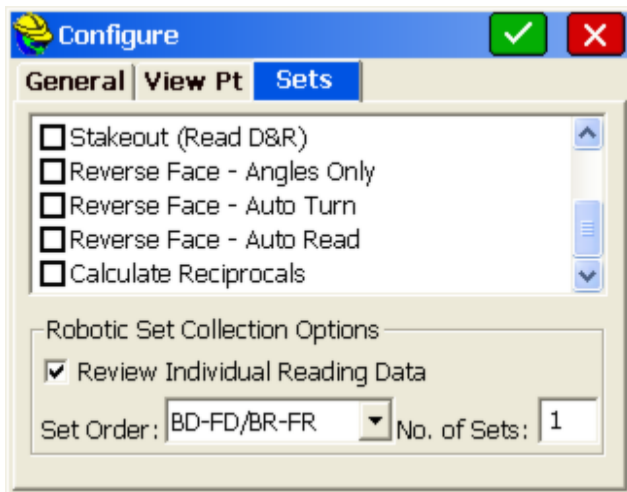
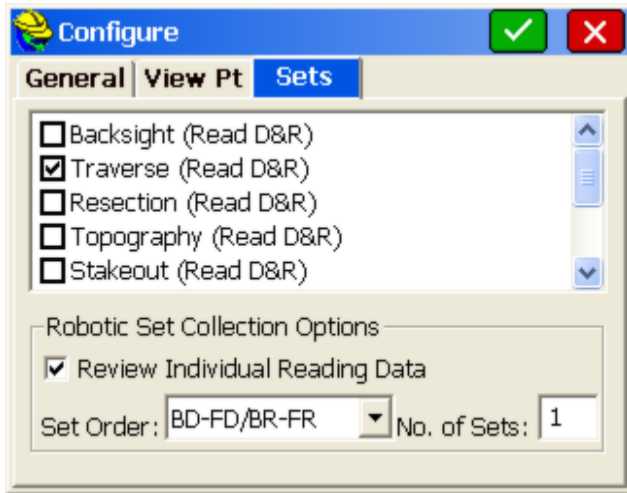

- D&R:** The user can choose to measure direct and reverse readings for backsight, traverse, resection, topography, or stakeout routines. If the user measures direct and reverse for the backsight readings, all foresight readings that also are recorded direct and reverse will be recorded and computed as angle sets. If the backsight reading is only measured direct, then foresight points that are measured direct and reverse are then combined to produce an average observation record for the vertical circle, which is stored in the .rw5 file as a sideshot (SS) record. For calculation purposes, the routine only averages the distances using both vertical circle readings, and uses the direct horizontal reading for the direction. Both the direct and reverse readings are stored in the .rw5 file as a note record. When disabled, (default setting) only the direct foresight shot will be taken. This option improves accuracy on elevation measurements and mimics a feature found on the SDR data collectors. The Resection D&R will also apply to Remote Benchmark.

- **Reciprocal Calc:** The Reciprocal Calculation option has three settings: No, Prompted, and Always. It governs the calculation of the elevation of foresight points taken with a total station, where a backsight measurement is also taken. When set to Always, the program will calculate the distance to the foresight point and delta elevation by combining the foresight and backsight measurements. When set to Prompted, the program will detect the backsight measurement and ask the user if the occupied point should be calculated using both previous foresight and current backsight. If set to No, the program calculates foresight points based only on the foresight measurement. If, for example, you had a vertical difference of +1.2 going up to the foresight, and then when you backsighted the difference was -1.0, the program would calculate the average difference (1.1) and would lower your occupied point by 0.1 “on-the-fly”, prior to conducting foresights. This is useful for multi-setup topo work, in particular, where no further adjustment is anticipated. For closed traverse or high-precision work, it is recommended that you run with Reciprocals off and use the adjustment options found in your office software or within Cogo, Process Raw File, in SurvCE. Reciprocals, because they re-calculate your occupied point by combining the backsight with the prior foresight information, should be used with care, because they will degrade the precision of the work if backsights are not precisely measured, with correct target heights.
- **Reverse Face Angles Only:** When taking Face 1 and Face 2 foresights, or when doing Set Collection, the program will use the distance from the direct reading only, but will use the horizontal and vertical angles from both the direct and reverse face readings. This setting is repeated and displayed within **Configure** in Set Collection. Any change in either location controls the setting. (Note that in Manual Total Station, you will be prompted for reverse face distance, but the entry will not be used.) When using robotic total stations, which do not take distance measurements in reverse face, setting Reverse Face Angles Only is necessary to use motorized direct and reverse readings.
- **Reverse Face - Auto Turn:** This option is for motorized instruments only and when enabled will automatically turn the instrument to the reverse face.
- **Reverse Face - Auto Read:** This option will immediately take a reading after the instrument has turned to the reverse face. You must make sure that the auto targeting option is on.

Localization

This command allows you to define the project coordinate system, geoid usage, and scale factors, as well as align on a local coordinate system for GPS. Further discussions on localization are found in *Tutorial 2* near the end of the manual.

System Tab

Click **Edit Projection List** to add to the list and to create user-defined projections. The user may select a predefined or create a user-defined coordinate projection system

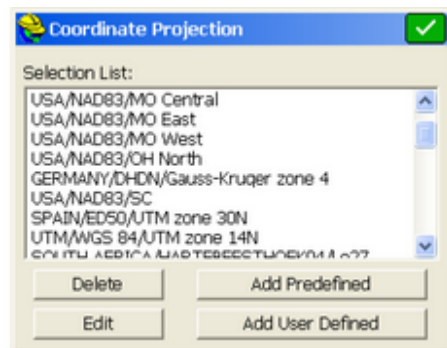
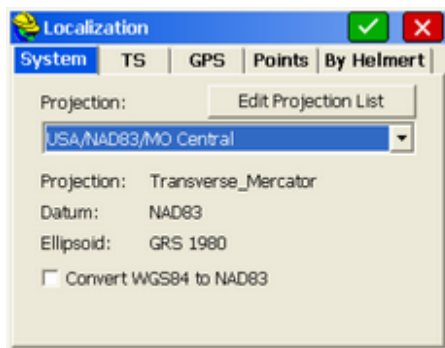

- **Projection:** If you click the arrow to the right of the current projection, you can select from a list of projections that you have previously created. But to select a projection that you haven't previously used, choose **Edit Projection List**.
- **Convert WGS84 to NAD83.** Most base stations in North America broadcast NAD83 positions. Topcon Base Reference networks sometimes are configured to use WGS84. Turn this option on when a North American base station is transmitting WGS84 positions. Leave this option off for all other situations.
- **Edit Projection List:** Click this button to select a predefined projection or define a new projection.
- **Add Predefined:** If you click **Add Predefined**, you can set the country/projection to use at the top of the dialog, then choose the zone within the projection. For example, in the United States, State Plane 83 is a common projection, with various grids available covering all states. If Austria is selected, options for that country appear.

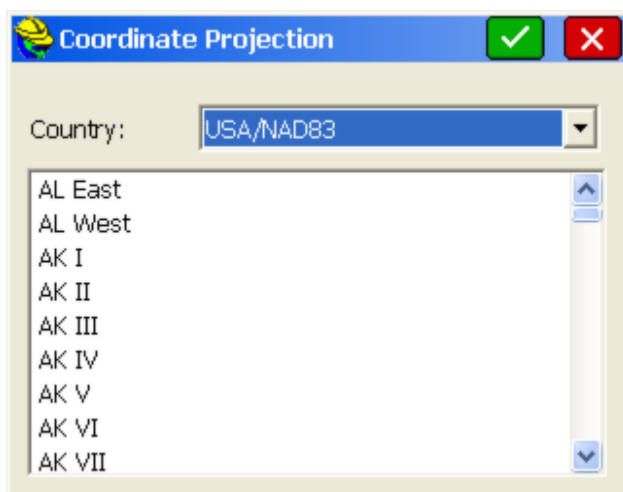

- **Country:** Some of the projections available for selection in the **Country** category are discussed below:

NAD 27: When selecting this coordinate system, you will also need to specify a state plane zone. SurvCE will use data files to perform a NADCON datum shift from WGS84 to NAD27 coordinates. By default, only data files for the continental U.S. are loaded to the data collector. If you are working outside this region, please load the appropriate files from your CD to the SurvStar\NADConv directory. NAD27 uses the Clarke 1866 ellipsoid.

NAD 83: When selecting this coordinate system, you will also need to specify a state plane zone. NAD 83 uses the GRS80 ellipsoid.

UTM: The ellipsoid used in the Universal Transverse Mercator calculation is determined by the Datum selection. If you choose the option, “WGS 84/Automatic Zone Selection”, the zone is determined by the lat/lon values read in from the receiver. If you know your UTM zone, you can also select it. Whenever SurvCE does a reverse calculation (from UTM to WGS84) you will be prompted to enter a zone number.

3TM (Canada): This system is also referred to as “MTM”. It is a 3 degree zone width Transverse Mercator calculation. You may select between the Clarke 1866 ellipsoid and the WGS84 ellipsoid.

New Zealand: You may select between “NZGD2000” and “NZGD49”. Both use the Transverse Mercator calculation. NZGD2000 uses the GRS80 ellipsoid. NZGD49 uses the International 1924 ellipsoid. You may specify a Meridional Circuit with either datum. To select the circuit, press the **Define** button. You will see a pull-down list with all Meridional Circuits as well as the option to pick **None**.

RGF 93 (France): This system requires that you have the file named “Predef1.csl” in the SurvStar directory on the data collector. If this file is not found, please re-install SurvCE.

NTF (France): This system requires that you have the file named “Predef1.csl” in the SurvStar directory on the data collector. If this file is not found, please re-install SurvCE. NTF is an approximation of the NTF-GR3DF97A grid transformation.

NTF-GR3DF97A: This system is a grid transformation that requires the files “Predef1.csl” and “gr3df97a.bin” to be in the SurvStar directory on the data collector. The “Predef1.csl” file is part of the default installation. You will need to use **Data Transfer** to copy the “gr3df97a.bin” file from your CD to your data collector.

OSTN02 (UK): This system is a grid transformation that requires the files “Predef1.csl”, “ostn02_x.bin” and “ostn02_y.bin”. The “Predef1.csl” file is part of the default installation. You will need to use **Data Transfer** to copy the “ostn02_x.bin” and “ostn02_y.bin” files from your CD to your data collector.

RD2000: This is the RD NAP transformation for the Netherlands. This system is a grid transformation that requires the file “Predef1.csl”, “X2C.grd” and “Y2C.grd”. The “Predef1.csl” file is part of the default installation. You will need to use **Data Transfer** to copy the “X2C.grd” and “Y2C.grd” files from your CD to your data collector.

Denmark 34: Used for all cadastral mapping and for most technical mapping carried out in Denmark. System 34 is a two dimensional -

horizontal - coordinate system. System 34 is based on the National Geodetic Reference Network and is divided into two different zones, one covering Jutland and Fuen, and the other covering Sealand. The island of Bornholm has its own coordinate system called System 45.

- **Add User Defined:** To define a new coordinate system, go to the Localization under the EQUIP tab. You will find the **Edit Projection List** button under the SYSTEM tab. Then select the **Add User Defined** button. Enter a name for your system (e.g. PRVI for Puerto Rico/Virgin Islands), then select a projection (in the example below, Lambert_Conformal_Conic_2SP) and enter the appropriate parameters. Note that all latitude and longitude values are in decimal degrees and False Northing and False Easting are always presented in meters. All entries involving degree must be in decimal degrees based on a 360 circle.

Field	Value
System:	PRVI
Projection:	Lambert_Conformal_Conic_1SP
Datum:	
Scale Factor:	1
C. Meridian:	-66.4333333
Lat. of Origin:	17.8333333
False Northing:	0 m
False Easting:	152400.3048 m

New Datum: You may select a predefined Ellipsoid or set your own parameters by typing in a new ellipsoid name and entering values for a and 1/f. The values for dX, dY, dZ, rot X, rot Y, rot Z and scale are “to WGS84”.

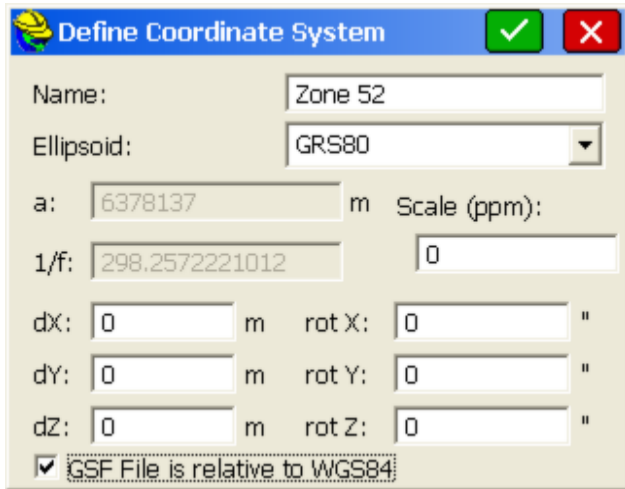

If the values you have are “from WGS84”, simply reverse the sign of each value (positive becomes negative and vice versa). You will need to save the system to a file. You may save the system to a “.sys” file or a “.csl” file. Sys files contain only one system definition. Csl files contain multiple system definitions. Both files are ASCII text files using OpenGIS WKT (Well Known Text) format.

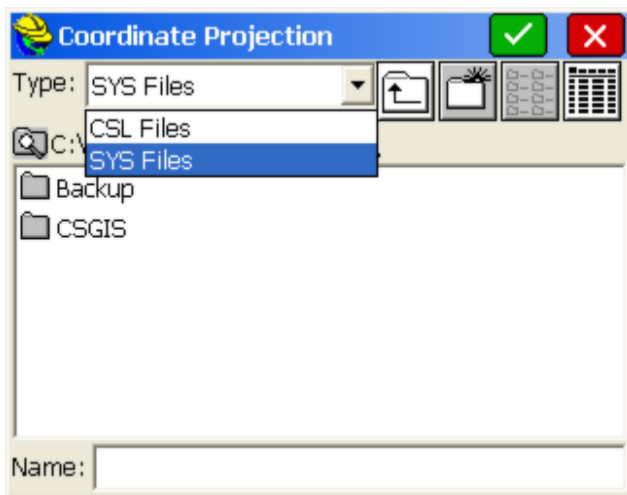

Load File: To load a user-defined coordinate system from a file, Click under the **Edit Projection List** button under the SYSTEM tab in Localization. Select **Add User Defined** and then **Load File**. Change the File Type at the top to “.sys” or “.csl” depending on the type of file you are loading. A “.sys” file will be associated with each job. You can load the projection last used on a survey job by loading its “.sys” file. Select your file and hit **OK**. If you have selected a “.csl” file, you will be asked to choose from a list of system definitions found in the file.

For the “.csl” type, you may verify that the details of your system have been loaded correctly by clicking the edit option.

TS Tab

The TS tab is where you specify the total station scale and adjustment options.

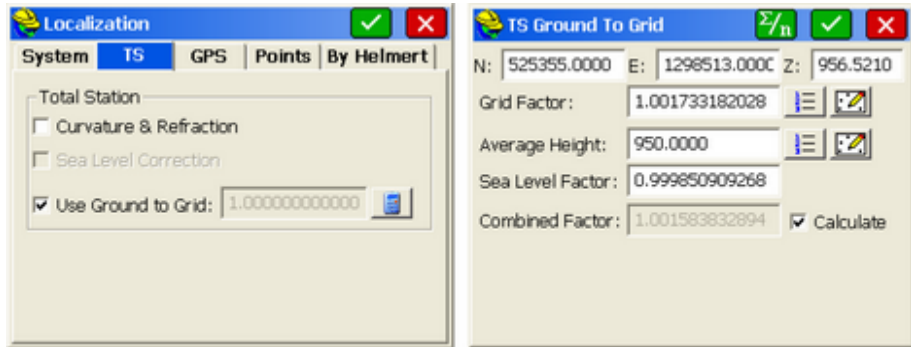

- **C & R (Curvature and Refraction):** This option applies only to total station configurations and will be unavailable when your instrument is configured to any GPS option. This factor causes an adjustment in distance measurement. Effects are negligible except over long distances. It is recommended that this toggle be enabled, except in those cases where the instrument factors in curvature and refraction.
- **Sea Level Correction:** If the sea level correction toggle is enabled (Use Ground to Grid is clicked off), the horizontal distance at the source point's elevation is reduced to the sea level chord using the mean height of the vector. Typically this value is negligible unless measuring very long distances.
- **Use Ground to Grid (Scale Factor):** If clicked on (as above), then you can automatically calculate the Ground to Grid factor. For most applications, the Ground to Grid Scale Factor for total station work should be set to 1.0. This uses the actual measurements from the total station for all distances. However to convert total station ground measurements to match GPS measurements, the ground to grid scale factor can be computed (or

hand-entered) by clicking the "Calculate" icon . This leads to the dialog at right (above). A local coordinate and average height can be entered or recalled from the list of points or from the map screen. This will compute the grid factor (from the projection) as well as the elevation factor to produce the combined grid/elevation factor that reduces ground distances to grid. Therefore, for total stations, the scale factor acts as a multiplier. All distance measurements taken by a total station will be multiplied by the scale factor. Because there are two potential uses of the scale factor (to adjust GPS measurements and to adjust total station measurements), two distinct scale factors are stored and recalled for any job, one for total stations located on the TS tab and one for GPS located on the GPS tab.

- **Average Icon:** The summation  or "averaging" icon at the top of the

dialog can be used to get an average height and coordinate position from a range of points. Here is an example where 5 points were used to create an "average" combined factor. This feature recognizes the different elevation impacts of metric versus English units. Be sure that the selected points have correct, non-zero elevations, or scroll right to the V On column and turn Vertical off for purposes of averaging.

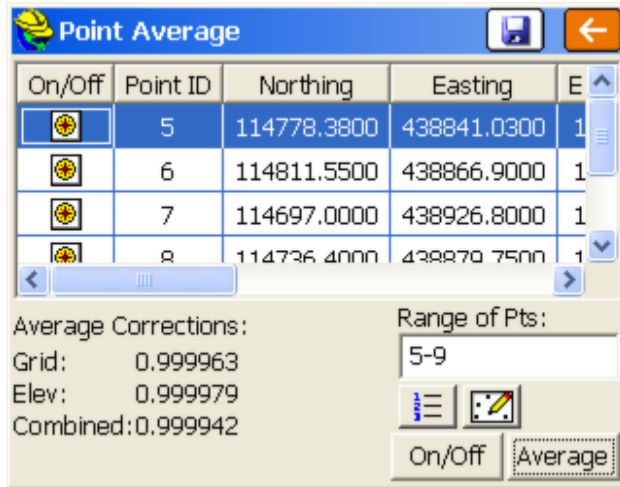

- **Calculate:** With Calculate turned on within the "TS Ground to Grid" dialog (at right), the Grid Factor is automatically multiplied by the Sea Level Factor to produce the Combined Factor. With Calculate turned off, you must directly type in the desired Ground to Grid Factor.

Note: The grid projection selected will even impact adjustment of of total station traverses and sideshots. Although the grid projection (eg. KY North, NAD 83) is typically only associated with GPS, the projection selected will impact adjustment of raw traverses. In the command File, Raw Data, when Process No Adjust or any adjustment routine is selected (eg. Compass Rule), the option to "Reduce to Grid Coordinates" can be selected. This will compute the combined scale factor at each endpoint of a traverse or sideshot, and then take the average combined scale factor and apply it to the measurement. Similarly, curvature and refraction can be applied as well. In this way, traverses from one known grid coordinate to another will achieve more accurate closures. It is not uncommon for traverses of considerable length and change in elevation to improve in closure from, for example, 1:10,000 to 1:100,000 with the application of both options. So the use of projections applies not only to GPS but to total station raw data processing.

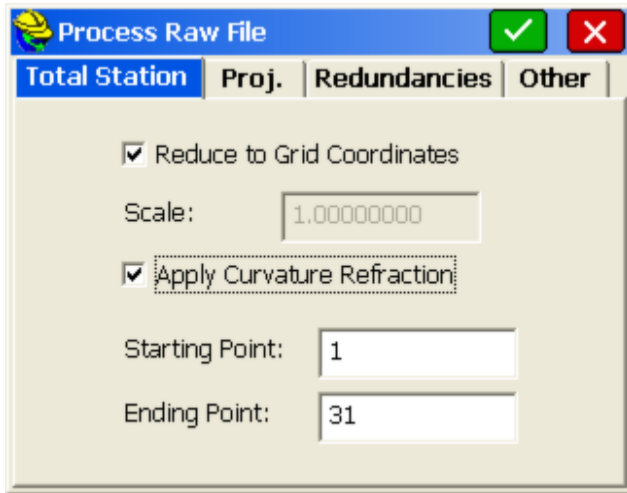

GPS Tab

The GPS tab is where you define the Localization methods, geoid file, and GPS scale factor.

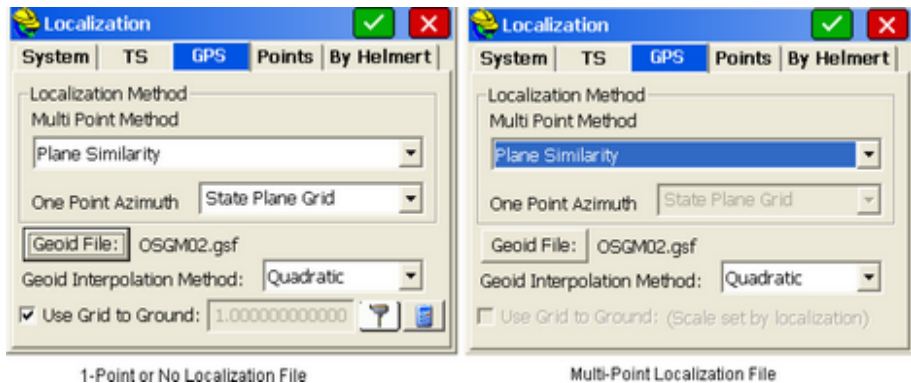

- Multi-Point Method (Transformation Types):** The transformation can be by plane similarity, rigid body, or seven-parameter Helmert methods. Plane Similarity and Rigid Body both use a best-fit least-squares transformation. The difference is that the rigid body method does a transformation with a translation and rotation, without scale. The plane similarity does a rotation, translation and scale. These two methods only apply when two or more points are held horizontally in the points tab. The Helmert method requires the user to enter the seven parameters on the BY HELMERT tab.

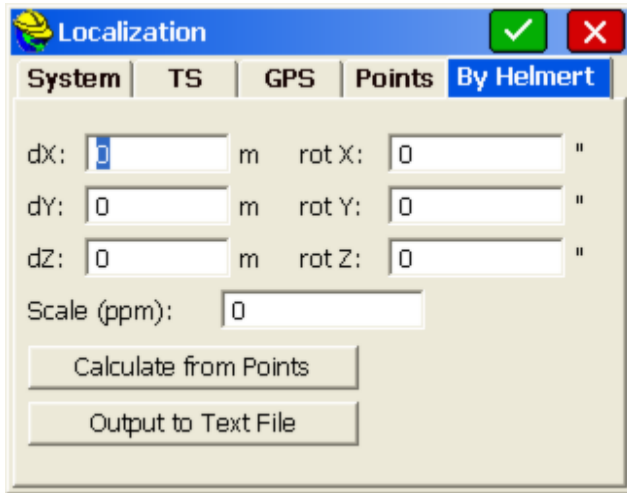

- **One Point Azimuth (North Type):** This option applies to the rotation when using one-point localization. For this alignment method, the grid coordinate is translated to the local coordinate. Then the rotation can use either grid north or geodetic north.
- **Use Grid to Ground (Scale Factor for GPS):** The Read GPS and Calculation options do not appear for multi-point localizations. In that case, the scale factor is fixed by the localization itself. When only 1 point is used for localization (for a translation), or no points are used in the localization file (position is derived from the reference station GPS), then you have the option to set a grid to ground scale factor. Icons allow you to "Read from



GPS" to auto-calculate the Grid to Ground factor or more formally



calculate the Grid to Ground factor using the **Calculate Icon**. For most applications, the Grid to Ground factor (scale factor) should be set to 1.0 to work on the grid coordinate system using GPS. The combined scale factor represents the "combined" grid/elevation factor that reduces ground distances to grid. Therefore, for GPS, the scale factor would be the reciprocal of the standard combined scale factor, taking you from grid to ground. The example below presents the options that appear when **Calculate** is selected. A coordinate is used to obtain the grid factor, and an average elevation is used to obtain the sea level factor. The combined factor is then computed. Since this combined factor is "ground to grid", the reciprocal is taken to obtain the "grid to ground" scale factor. Since the scaling must be based on a "scale point", it is necessary to enter the scale point in the lower portion of the dialog shown below. The scale point can be entered, you can take a GPS reading, or it can be set to the single point in the Localization file.

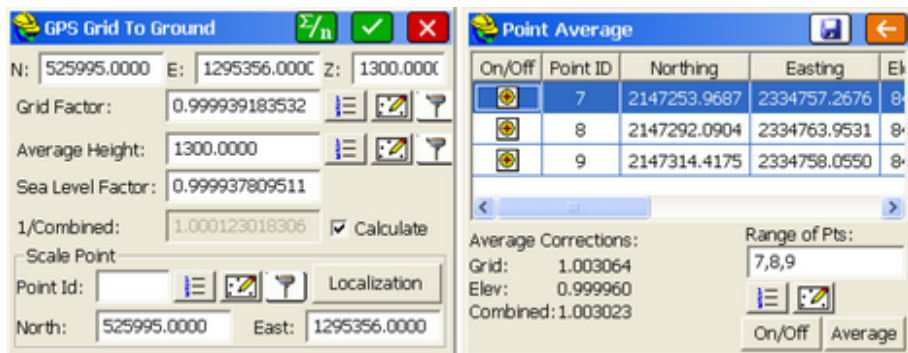

Within the Calculate option, using the Read GPS icon  obtains the coordinates to be used for scaling and for the scale point by **Read GPS**. Alternately, you can enter the coordinates, pick them from a list, or select from the map. In GPS, the Scale Factor (1/Combined) is applied to the distance between the coordinate and a base point. The coordinate is then set by starting from the base point and moving in the direction to the coordinate for the adjusted distance.

In the "GPS Grid to Ground" dialog above, you can click off "Calculate" and simply hand enter the 1/Combined scale factor. You can also click the

"Summation" icon  at the top of the dialog and obtain the combined factor from an averaged selection of points. The combined factor, always "Ground to Grid", will then be inversed and displayed as 1/Combined to represent "Grid to Ground". In the form of 1/Combined, it acts as a multiplier to scale all GPS measurements from the Scale Point.

- Geoid Separation File** : This option will incorporate the geoid undulation in determining the orthometric elevation of the measurement. The definition of the geoid model as currently adopted by the National Geodetic Survey is the equipotential surface of the Earth's gravity field which best fits, in a least squares sense, global mean sea level. Orthometric elevation measurements are used in survey calculations. In order to convert ellipsoid heights (H_e) as measured by GPS into orthometric elevations (E_o), you must provide for a correction between the GPS-measured ellipsoid (reference ellipsoid) and a constant level gravitational surface, the geoid. This correction is the geoid undulation (U_g). Use XPort or SurvCOM to download the Geoid Separation File. This option only has significant impact with one-point or no-point (reference station-based) alignments. The zip file containing the Geoid Files (GSF, Geoid99 or EGM) is found on the SurvCE installation CD, and a portion of any such file can be specified (by size and center point) for downloading to the data collector using Carlson X-Port or Carlson SurvCom.

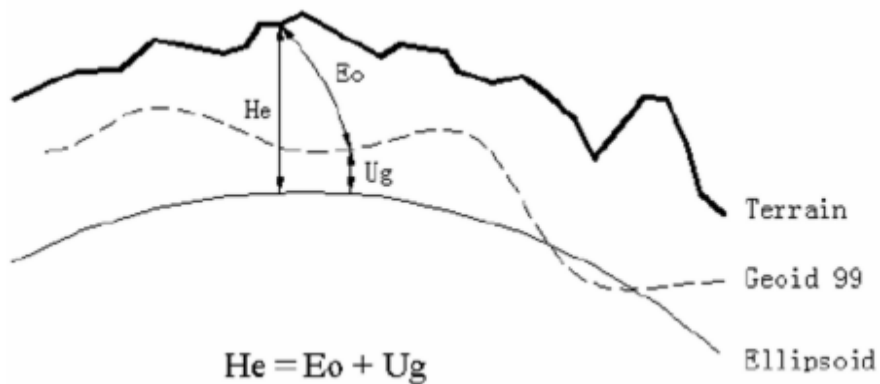

- **Geoid Interpolation Method** : Three methods are provided: Quadratic, Bilinear and Bi Cubic Spline. The default setting is Quadratic.

How To Use Geoid Files with Carlson SurvCE

1. Download and/or install either Carlson X-Port or SurvCOM to the desktop computer.
2. Download and/or install “CarlsonGeoidGrids.exe” to a location on your desktop computer (Typically installed to the “...Program Files\Carlson X-Port\” directory).
3. If you have Microsoft ActiveSync already installed on your computer, make sure that it is not currently occupying the COM port.

To do this:

Launch ActiveSync and select **Connection Settings** from the **File** menu.

Remove the check box that refers to the port you intend to use with Carlson X-Port (Typically COM1).

Select **OK** to exit **Connection Settings** and close ActiveSync.

4. Connect your handheld device to your desktop computer using a serial cable.
5. Run Carlson SurvCE on the handheld device and select **Data Transfer** from the **FILE** tab.
6. From within the **Data Transfer** dialog, select the **Carlson Civil/Carlson Survey Transfer** option.
7. Leave the data collector waiting for communications as shown by the resulting **File Transfer** dialog.
8. Launch either Carlson X-Port or SurvCOM from your desktop computer. If you are using Carlson X-Port, select **Carlson SurvCE** from the **Tools** menu to launch SurvCOM.
9. From within SurvCOM, and while connected to the handheld computer via a serial cable, you should be able to see the contents of the handheld device on the right and the contents of the desktop computer on the left simultaneously. If you do not see the handheld device on the right, you are not connected.
10. Select the **Geoid** icon located at the bottom of the **SurvCOM** dialog.
11. From within the **Set Geoid Area** dialog, verify the path to the geoid files is

set to the installed location of these files as defined in step 2 of this document (Typically "...Program Files\Carlson X-Port\").

12. Select the desired geoid model to extract an area from.
13. Key in the approximate latitude and longitude of the center of the area.
14. Define the grid size for the area you want the model to cover (Supported sizes are 50-250 miles, 80-400 kilometers and 1-5 degrees, however, keep the size 100 miles or smaller for better performance).
15. Name the geoid model with any name that you want (e.g. "geoid"). You may want to name this file with a logical name for the location of the area for future reference (e.g. "geoid-LA").
16. Select the **OK** button to automatically transfer the file to the "...\Survstar" directory of the handheld device. A copy of the file will also be created on your desktop computer in the currently selected folder.
17. On the handheld device, go to the FILE tab and select **Job Settings**, then choose the GPS tab.
18. Select the **Geoid Separation File** button and choose the geoid file you created and transferred with SurvCOM.
19. You have now completed the definition and selection of the geoid file. Select **OK** to exit the **Job Settings** dialog.

Points Tab

This tab is where the user adds pairs of positions to create a localization.

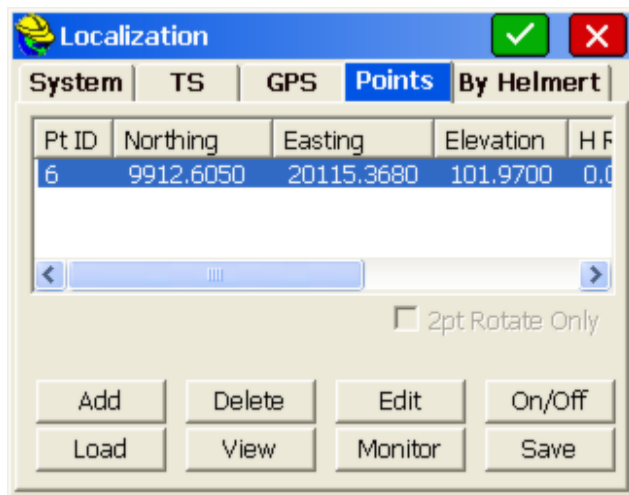

- **View:** The local coordinates are shown in the POINTS tab by default. Pressing **View** will switch the view to show the geodetic, Lat/Lon coordinates.
- **Scale:** The Scale Factor, shown in the Localization dialog when two or more localization points are used, is a multiplier and represents "grid to ground". When configured to GPS in release 1.50.004 or higher of SurvCE, any GPS localization scale factor is displayed within the UNITS tab of **Job Settings** in inverse form to represent "ground to grid".
- **Add:** Enter the alignment or localization points by coordinate values or by

entering a point number. If you choose the point number method, you can enter a point number or select them from the point list. If you choose the **From List** method, you can access points in the Control File, if a Control File is active (See Job Settings, Options). You can average as many readings as you like when you add points, and view the range and residuals. It is recommended that you use the point number option and carefully hand-enter your local grid system coordinates first, using either List Points, option **Add**, or Keyboard Input. Entry of coordinates “on-the-fly”, in the field, provides opportunity for error. Once you click **OK** in the coordinate dialog, you will have three options for establishing the GPS position for the named local point.

Add Method 1--Read GPS: This allows you to collect measurements from the GPS receiver and average as many readings as you choose. Once the readings are complete, the software will present a dialog that displays the range and residuals of the averaged readings.

Add Method 2--Enter Latitude/Longitude: This allows you to hand-enter known geodetic coordinates for the local position. The elevation should be the ellipsoid elevation in the current job units if a geoid model is not applied. If a geoid model is applied, then the elevation should be the orthometric elevation in the current job units. This method allows manual entry of a localization file without occupying points in the field. Note that you do not enter the decimal point for decimal seconds.

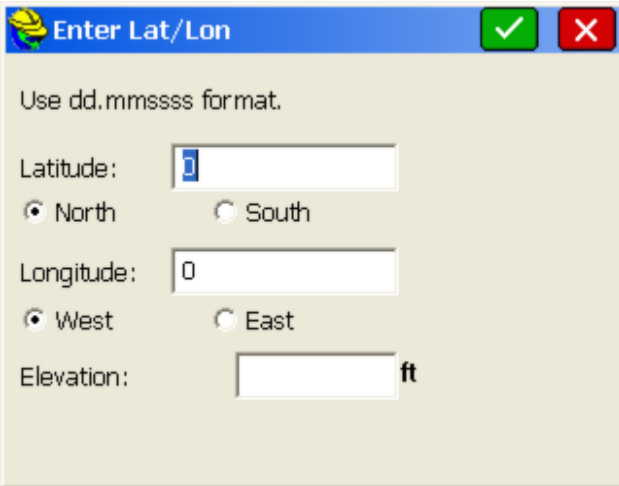

The image shows a software dialog box titled "Enter Lat/Lon". The dialog box has a blue title bar with a globe icon on the left and green checkmark and red X buttons on the right. The main area is light beige and contains the text "Use dd.mmsssss format." followed by three input sections. The first section is "Latitude:" with a text box containing "0" and two radio buttons labeled "North" (selected) and "South". The second section is "Longitude:" with a text box containing "0" and two radio buttons labeled "West" (selected) and "East". The third section is "Elevation:" with a text box and the unit "ft" to its right.

If you use manual entry of a localization data set, it is important that you either utilize an existing base GPS receiver with the fixed antenna location that was used to survey the original geodetic positions, or that you set up your base on a known GPS position measured previously using that localization data set. Good survey practice would include checking into known positions to verify the quality of your hand-entered GPS localization and verifying low residuals in the Localization screen.

With all data pairs used for both horizontal and vertical control (none turned off), the resolutions for this data set will appear.

Add Method 3--From Raw File: This allows you to use a point from the raw data file that has been previously collected via GPS. This is just like **Read from GPS** except you are recalling a point previously measured and stored in the raw file. For this to work, you must have the base antenna in the same position as when the original raw file was collected, or you need to set your base antenna over a known coordinate from the original survey, and enter those original coordinates and the new base antenna height within the command Configure Base.

- **Delete:** Allows you to delete the selected item from the list. Note that it is not necessary to delete a localization point if you simply want to avoid using it. You can disable both the horizontal and vertical component of the point, but keep it available for use later.
- **Edit:** Allows you to edit the selected item in the list. It will display the northing, easting and elevation of the localization point, which can be changed.
- **On/Off:** Allows you to remove the horizontal or vertical components of your localization points. This is a frequently used feature that enables the use of one point for vertical control only (turn off its horizontal component) and other points for horizontal control (turn off their vertical, if appropriate). Points with no known elevation (0 for example), would obviously be used only for horizontal control, as shown in this example.

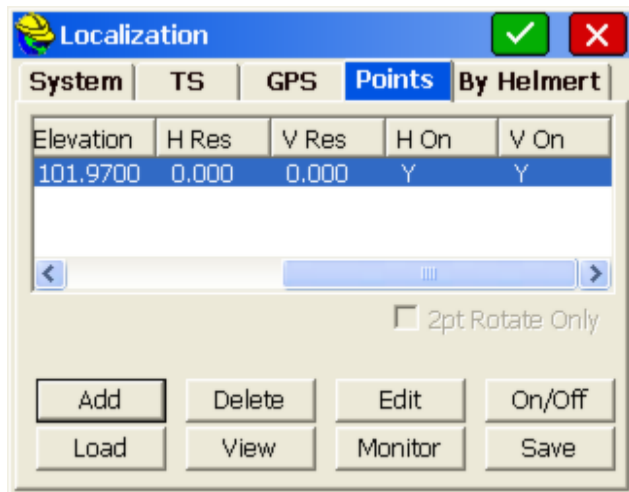

Note that in this example, it takes three horizontal control points, active "H On = Y" to get horizontal residual results, and four vertical control points, active "V On = Y" to get vertical residual results. You can employ trial and error to remove different points from consideration both vertically and horizontally and watch the residuals of the remaining control points improve or degrade. In this way, if you have four or more total control points, you can

determine the best combination to use as horizontal and vertical control.

- **Load:** This allows you to load any localization file for modifying or for the purpose of associating it to the current job. Note that the **OK** button must be used if the intention is to associate the loaded file to the current job.
- **Monitor:** Goes to the standard Monitor screen. This is particularly useful to verify the quality of your satellite coverage and your fixed or float status. You always want the best possible fixed status when conducting a rover-based localization.
- **Save:** Allows you to save the control points in a file.
- **2 pt Rotate Only:** Allows you to use the second point in the localization file for direction but not for scaling. In this case, any scale factor set on the UNITS tab in **Job Settings** would be active.
- **OK:** Pressing **OK** will temporarily recall the current Localization as you work. If you change the Localization file, **Save**, then **Cancel**, the original Localization file will still be active. Pressing **OK** is what makes it active, and current. In this case, you would need to Load the new Localization file and press **OK** to make it active. You can choose to **Add** localization points midway on a job, and not actually use them by pressing **Save**, then **Cancel**. Then when the job is complete, you can recall the Localization file with all the old and added localization points, go to **Process Raw File**, and re-calculate all surveying points according to the new Localization.

Discussion of Localization Techniques

If you do a base localization by entering Latitude and Longitude or known coordinates on the designated coordinate system, then you do not need to add localization points. A base localization would put you on grid north and grid scale and would work for any new job where you are not trying to match existing coordinates. However, any time you are working on a project that has existing coordinates, you will most likely need to do a Localization. Even if that existing job is supposedly on state plane, UTM or another known coordinate system, the project coordinates often fail to match grid scale and grid north exactly, requiring localization. When localizing, it is advisable to use at least three points for horizontal control and four points for vertical control, in order to get a measure of residuals (or accuracy). The program will “best fit” a plane through all activated (H=On and/or V=On) control points. The residuals are how much each activated point is off of the plane surface. Because multiple elevation points may create a slightly tilted plane, some surveyors will verify that the vertical control has low residuals and is accurate using multiple vertical control points, then turn off all but one (V=Off) and use only the nearest vertical (elevation) as they progress through the job.

Note: The Scale Factor chosen in UNITS under **Job Settings** will cause all GPS measurements to be adjusted by the scale factor. For GPS, scale factors can only be entered for one-point localizations (base or rover). For multi-point rover localizations, the scale factor is computed by the localization and fixed. It appears grayed out under UNITS in **Job Settings**. When a scale factor is used for one-point localizations, scaling occurs along the vector outward from the single localization point in the direction of the

measured point. For GPS, the scale factor acts as a divisor. A scale factor of 0.9 will calculate the measured point 1/0.9 units further away from the single localization point. Therefore, it is recommended that you keep the scale factor set to 1.0. When configured to total station, the scale factor is sometimes used to go “ground to grid”. When configured to GPS, the scale factor is sometimes used to go “grid to ground”, to better match total station scaling. The scale factor is defined as “ground to grid”. To go “ground to grid” from high elevations, for example, it would be less than 1. It would multiply total station measurements and reduce them to grid. It would divide GPS measurements and expand them to ground. If your goal is to work on the specified state plane, UTM or other grid coordinate system, and you are planning to use a one-point localization, then the scale factor should be set to 1, unless you are trying to match “ground” coordinates, where the coordinates are “true north” but not “true scale”. In all other cases, matching ground coordinates with GPS is best accomplished with a multi-point rover-based localization. The resulting “effective” scale factor multiplier will appear in the localization screen, such as the 0.999779 value shown in the last figure.

After a change in a localization file, any points measured in the field by GPS will be converted from Lat/Long to local coordinates by using the new localization file. For this reason, it is a good idea to re-convert older GPS measurements to the same, compatible coordinate system by going to **Process Raw Data**, option **Process GPS**, within the COGO tab.

Geoid Files

The Geoid file is loaded onto SurvCE using Carlson X-Port. You first select the area of interest, then X-Port “carves out” the geoid for that area and downloads it to SurvCE. You set the Geoid file in the EQUIP tab in the main menu and then tap **Localization**. In the Localization routine, tap the **GPS** tab and then tap the **Geoid File** button. The Geoid should be used principally with one-point localizations. Starting with a known position for the base (or using a one-point rover localization and approximate base position), the program will add or deduct the geoidal separation from the computed Z value on all measurements, and will match more closely to geoid-based surface elevations. The Geoid can also be used with multiple-point rover localizations, since the added accuracy provided by the geoidal calculation can reduce vertical residuals. This is true, however, only if the points being matched had Z values that, themselves, considered the geoid. Since you will get a best-fit plane that minimizes vertical residuals with or without use of the geoid, it is often not used with rover-based localizations.

Changing or Updating the Localization File

There are two ways to change a localization file. One method is to edit an existing file by deleting elements, and the second is to add additional localization points. In either case, whenever a change in the “.dat” localization file is detected, you are prompted whether you would like to re-process any previously stored GPS points found in the raw file. The dialog below appears.

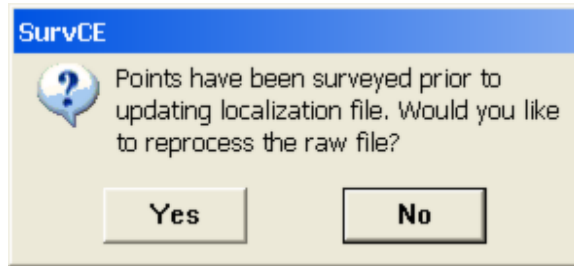

If you answer **Yes**, you will be directed to the **Process GPS** command found within **COGO**, **Process Raw File**.

Recalculating Stored GPS Points

There is no requirement to survey all localization points first, unless you are doing stakeout. For simple topo or data gathering, you can set up your base, survey in one or two localization points with the rover, then gather data in **Store Points** as needed. As you move cross country and encounter another known, or unexpected, control point, you can localize on it and add it to the list. The next step would be to verify residuals, and if the results are good, you can reprocess the raw file and keep your entire survey fully updated. If the residuals are disappointing, you can choose not to include the new point in the localization file. Either remove it or turn its H and V components off. You can also choose **Process Raw File** to recalculate all GPS measurements at any time.

Including the Base Position in the Localization File

To use the base in the localization, you should configure the base with the **Use Local Coordinates** option under **From Known Position**. Here, you configure the base by entering the local point (5000,5000,100, etc.) and start a new localization file (or use an existing one if it applies). Then, at your rover, you can add more points to the localization as necessary.

Localization and the Raw File

If the scale for GPS is determined from the localization, a “GPS Scale” record of 1.0 and a “Localization Scale” equal to the calculated scale appearing in the Localization screen will be written to the RW5 file.

Using the Localization File to Improve Base Localizations through Logging Static Data

The Localization File (.dat) typically applies to rover-based localizations. But if you did a **Read GPS** on your base antenna position and then took GPS shots with no rover localization, and logged static data on the base in the meantime, it is possible to submit that logged information to the OPUS program and obtain an accurate base position. At this point, it is still possible to recalculate all the field shots taken earlier from the less accurate base. To do so, follow the procedure outlined below.

1. Store the Base Point (Reference Tab in the Monitor screen).
2. Add a point to the now-empty Localization File. For the local point, enter the grid system coordinate computed by OPUS or other program. For the geodetic Lat/Lon point, review the raw file and select the point you stored for

the base.

3. Reprocess the raw file through the localization. All CRD points should then be relative to the new calculated (eg. OPUS-generated) coordinate

Monitor/SkyPlot (GPS)

The Monitor/Skyplot command allows you to review local position and quality of data.

- **Quality:** Under the QUALITY tab you monitor the status and number of satellites. You can also review the horizontal and vertical RMS values, as well as HDOP, VDOP, PDOP, TDOP and GDOP values. Some instruments refer to RMS values as CEP and SEP. For the CSI DGPS and the Sokkia Axis 3 receivers using OmniStar, the BER value will be shown in order to give indication of the strength of corrections received. When set to CSI DGPS, the age of corrections is also displayed. The number of satellites (SATS) is shown.

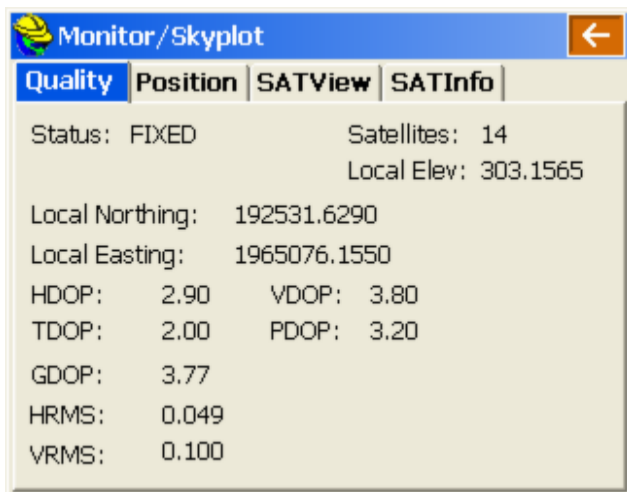

The Status is shown as either:

AUTONOMOUS: No radio communication between base and rover.

DGPS: Corrections from differential sources such as WAAS or SBAS.

FLOAT: Communication has been established, but ambiguities have not been resolved.

FIXED: Position has been resolved.

- **Position:** Under the POSITION tab you see the current position given in latitude, longitude, ellipsoid elevation, geoid separation, and orthometric elevation. You will also see the local grid coordinates here.

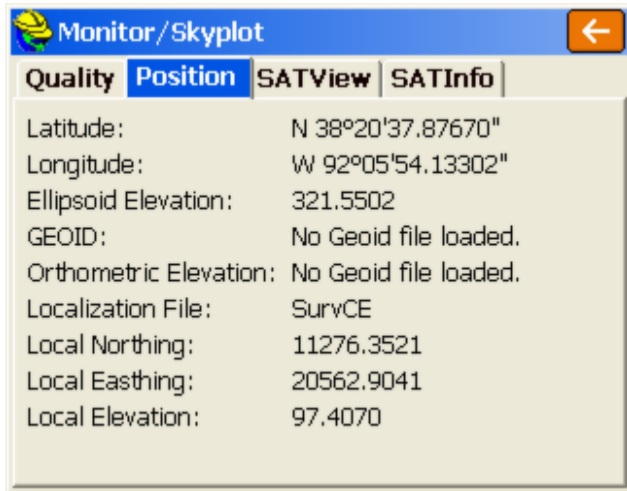

- SATView:** Under the SATView tab, the spatial orientation of the satellite constellation is shown. You can also see if the satellite is rising or falling in the sky, by the associated arrow. Click on any satellite number to see individual satellite details, including the precise signal/noise ratio. You can also toggle satellites on and off if supported by the GPS. If a satellite is turned off, it displays with a line through it within the Signal/Noise Ratio graphs.

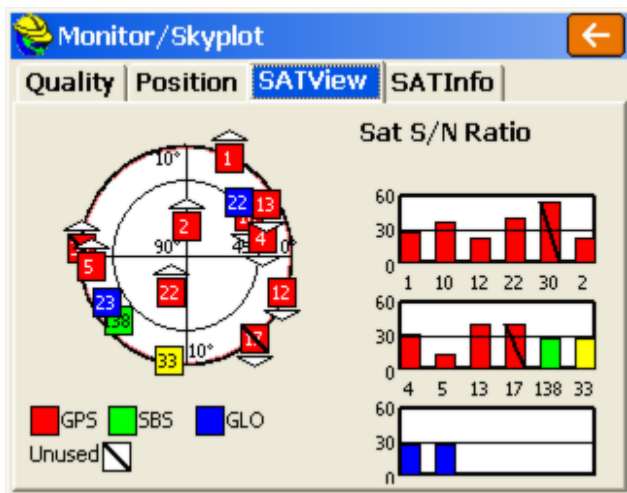

- SATInfo:** This tab shows information on Satellites.
- PRN is the satellite reference numbers. * indicates satellite in use for position calculation.
- TYPE: GPS vs Glonass and SBS
- AZI: is the satellite azimuth.

- ELV: is the satellite elevation above the horizon, including rising (>) and falling (<) direction. The "*" designation indicates that the satellite is used in the calculation of position.

PRN	TYPE	AZI	ELV
1*	GPS	24	10>
10*	GPS	58	45<
12*	GPS	110	15<
22*	GPS	205	68>
30	GPS	275	5>
2*	GPS	358	74>
4*	GPS	77	43<
5*	GPS	264	26>
13*	GPS	57	27<
17	GPS	140	7<
120*	GPS	227	20

- **Ref:** The REF tab to the right of SAT Info appears with most GPS configurations (not with GPS Simulation). The REF tab will show the base station information stored to the reference file, which is created during base configuration. The Magellan/Ashtech GPS, for example, will show the distance from rover to base. The base coordinates can also be stored by pressing the **Store** button.

You simply enter a point number and description, and the precise base coordinates are stored in north, east and elevation, according to the localization file settings. Then the base coordinate point can be used for total station work as a setup or backsight. If a base position of 0,0,0 is detected, representing in invalid base setup, the **Store** button will be grayed out.

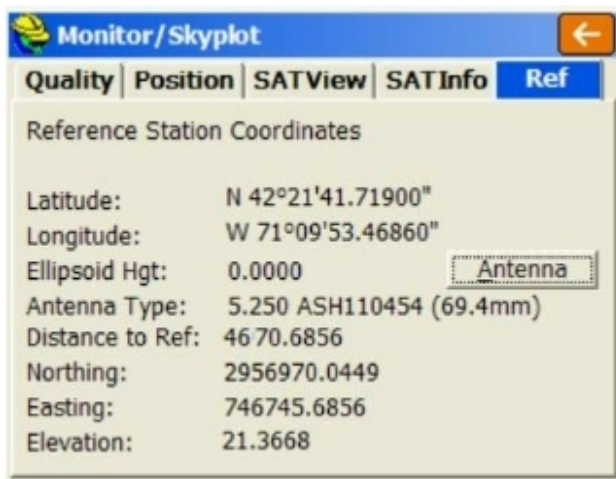

With Leica GPS, it also shows the status of the radio signal in the middle two lines. If the radio signal is interrupted, a "No Radio" message will appear. The **Utilities** button associated with the Leica GPS configuration takes you straight to the radio settings, including cell modem configuration.

Check Level (Total Station)

This feature is only available on instruments that provide information from electronic compensators. It allows the user to Check the level of the instrument from within the software.

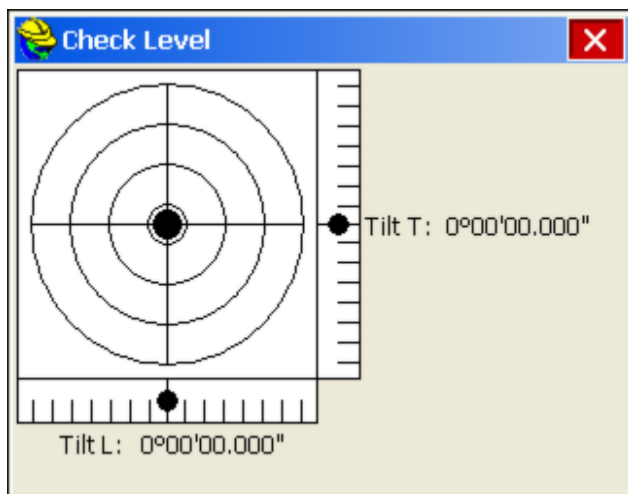

- **Tilt T:** Shows the compensator value.
- **Tilt L:** Shows the compensator value.

Tolerances

This command allows you to set operating tolerances for the collection of points.

Total Station Tolerances:

The screenshot shows a dialog box titled "Tolerances" with a blue header bar containing a yellow surveying icon and a green checkmark button. The dialog has a light beige background and contains four input fields:

- H. Obs:** A text box containing "0°00'30"
- V. Obs:** A text box containing "0°00'30"
- Edm tol (mm):** A text box containing "5"
- Stakeout Tol:** A text box containing "0.328" followed by the unit "ft"

- **H. Obs:** This specifies the horizontal observation tolerance as an angle field. A tolerance of zero is not allowed.
- **V. Obs:** This specifies the vertical observation tolerance as an angle field. A tolerance of zero is not allowed.
- **Edm tol (mm):** EDM fixed tolerance in millimeters specifies the EDM error that is independent of the length of the line measured.
- **Stakeout Tol:** This specifies the maximum difference between the target location and actual staked point. When the staked point is beyond the tolerance, SurvCE displays a warning dialog. The Stakeout Tolerance is systematically applied to all stakeout commands. The program will respond with a warning screen such as "Stakeout is beyond the Tolerance Setting. Do you wish to continue storing?" The angle and distance tolerances are applied to multiple distance measurements (when **Configure Reading** specifies multiple **Num Dist Readings**) and when multiple angle measurements are taken in **Set Collection** or processed in **Process Raw File**.

GPS Tolerances:

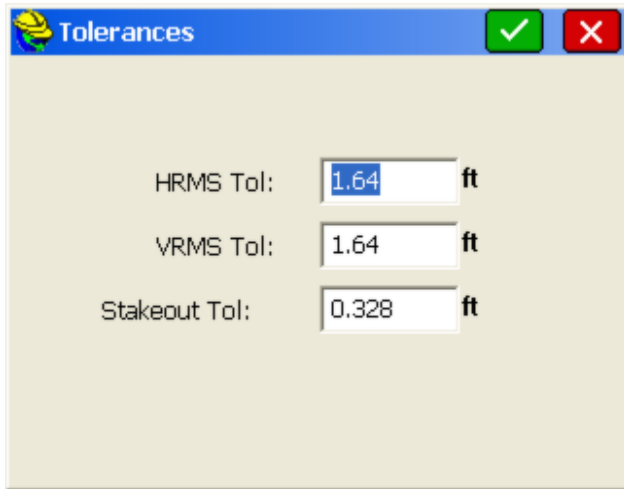

- **CEP/HRMS Tol:** A measurement of accuracy defined by the radius of the circle containing 50 percent of the individual measurements being made, or the radius of the circle within which there is a 50 percent probability of being located.
- **SEP/VRMS Tol:** A measurement of accuracy defined by a sphere within which there is a 50 percent probability of locating a point or being located. SEP is the three-dimensional analogue of CEP.
- **Stakeout Tol:** This specifies the maximum difference between the target location and actual staked point. When the staked point is beyond the tolerance, SurvCE displays a warning dialog.

Note: CEP tolerance and SEP tolerance are only used by Trimble. All others refer to it as HRMS and VRMS Tolerance.

Note: Even if you are fixed, if you attempt to store points and your GPS tolerance values are exceeded, you will obtain a warning screen.

Peripherals

A Peripheral is a device that must be used in tandem with a GPS receiver or a total station. Peripherals can all be configured from the **Peripherals** menu under the EQUIP tab. Lasers, Light Bars, and Depth Sounders are all supported as peripherals. If a peripheral is not currently in use, it is strongly recommended that you deactivate it, so it does not slow down other operations. Lasers such as the Leica Disto can be used for horizontal offsets, and can be set to supplement the rod height for data collection “at the pole” using robotic total stations or GPS for marine or ATV surveys.

Lasers

Currently supported lasers are Laser Atlanta, Leica Disto, Laser Impulse IP200, Laser Impulse CR400, and Sokkia Contour. If you have a different laser, contact Carlson Software to discuss adding support for it. With GPS enabled, a laser can

be used to provide an offset from a GPS reading. For more information, see the *GPS Offset* section of the manual. With a robotic total station enabled, a laser can be used to automatically measure the rod height of each total station reading.

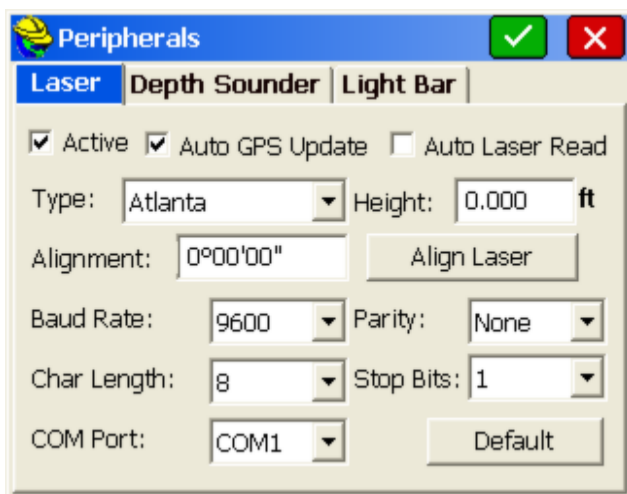

To activate a laser for use with GPS, follow these steps:

1. Plug in your laser to any of your device's COM ports; make sure that it is adequately charged, and turn it on.
2. Enter the **Peripherals** menu, and select the **LASER** tab, as shown above.
3. Check **Active**
4. Select the type of laser you are using.
5. Enter the height of your laser from the ground. This value will be added to the vertical offset returned by your laser. For accuracy, this value should be specified with respect to the same ground elevation that your GPS rod height was specified.
6. Directions for aligning your laser will be given in a different section. For now, leave the laser alignment value set to 0.
7. If you want GPS to be automatically updated between each laser read, enable **Auto GPS Update**. If you want the **Read Laser** button to automatically trigger the laser, enable **Auto Laser Read**.
8. Set appropriate COM port settings. To load the default settings for the laser you specified, select the **Default** button. However, you will still need to set your COM port number manually.
9. Click **OK** to save settings, or **Cancel** to revert back to your old settings.

Activating a laser for use with a robotic total station follows a similar procedure. Attach the laser to the prism, pointing towards the ground. Every total station read will automatically trigger the laser, and the read value will be used as the rod height.

Using the Laser

1. Once the laser has been properly set up, enter the GPS Offset method and press **Read Laser**.

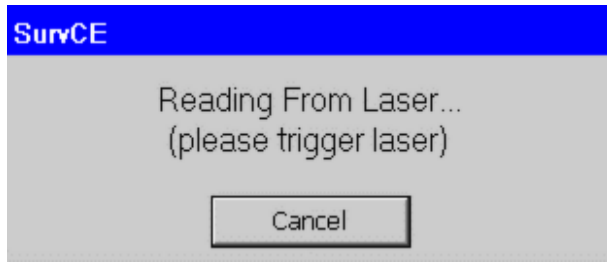

2. A progress window should pop up, indicating that Carlson SurvCE is ready to read from the laser. Aim the laser and fire at a target point. Keep firing until your laser returns a valid reading, and the progress window disappears.
3. To test whether your shot was successful, verify that the values on your screen correspond to the values on your laser's internal display. Note that not all lasers return azimuth and vertical offset data, in which case this information will have to be entered manually.

Laser Alignment

This option is only relevant to lasers with internal compasses. The purpose of this option is to allow you to compensate for any discrepancy between the laser's internal compass and the North determined by GPS. The alignment factor will be automatically added to all azimuth values returned by the laser. The alignment factor can either be entered manually, or calculated using the laser and GPS. To calculate this factor using the laser, follow these steps:

1. If you don't already have two known points in your vicinity, use GPS to store two points within 50 feet of each other.
2. From the LASER tab of the Peripherals window, select **Align Laser**.

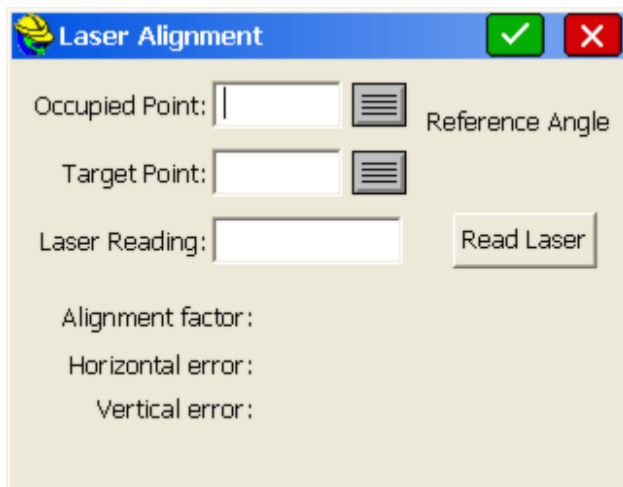

3. Choose an Occupied Point from your point list, and prepare to fire your laser from that point.
4. Choose a Target Point from your point list, and prepare to fire your laser at

that point.

5. Click **Read Laser**, and when the "Reading Laser" progress bar appears, fire your laser at the target point from your occupied point. An azimuth reading will appear in the Laser Reading box, and two values will be calculated. The Reference Angle is the azimuth of the vector from the occupied point to the target point. The Alignment Factor is the difference between the azimuth read by the laser and the Reference Angle.
6. Press **OK**, and the Alignment Factor that was calculated will appear in the Laser Alignment box.
7. Click **OK** again to save the new alignment settings.

Laser-Specific Configurations

If you're having trouble establishing communication with the laser, you may need to change certain settings on your laser's instrument panel. Here are laser-specific setup instructions for some of the lasers supported by SurvCE.

- **Laser Atlanta:** Make sure your Laser Atlanta baud-rate and message formats agree with those you specified in SurvCE. Also, make sure the laser format is set to **Laser Atlanta Original (LA1KA)**. Consult your Laser Atlanta manual for instructions on how to do this.
- **Laser Impulse:** Make sure your Laser Impulse baud-rate and message formats agree with those you specified in SurvCE. Supported formats are IP200, and CR400. Consult your Laser Impulse manual for instructions on how to do this.
- **Leica Disto:** Make sure your Leica Disto's baud-rate agrees with those you specified in SurvCE. Consult your Laser Impulse manual for instructions.
- **Sokkia Contour:** Make sure your Sokkia Contour's baud-rate agrees with those specified in SurvCE. Consult your Sokkia Contour manual for instructions.
- **MDL LaserAce:** Using SurvCE 1.50.008 (or higher), you can use the LaserAce, but should configure your peripherals screen to Impulse (CR400). Using the MDL selection will invert the inclination. Use 9600 baud rate. Use a Topcon/Sokkia data cable (not a Nikon cable!). The laser must be configured to the same units as the job since SurvCE does not convert the measurement.

Depth Sounders

Currently supported depth sounders are Horizon, Hydrotrac, Innerspace, and Odom Digitrace. If you have a different depth sounder, contact Carlson Software to discuss adding support for it. You can use a depth sounder with GPS to map an underwater surface. When the depth sounder is enabled, SurvCE will alternate between reading from GPS and reading from the depth sounder, so if you aren't using a depth sounder, you must be sure this feature has been deactivated, or you may experience slow GPS readings. When active, incoming Depth readings are viewable in Monitor/Skyplot. Elevation values in the Store Point screen are automatically depth adjusted.

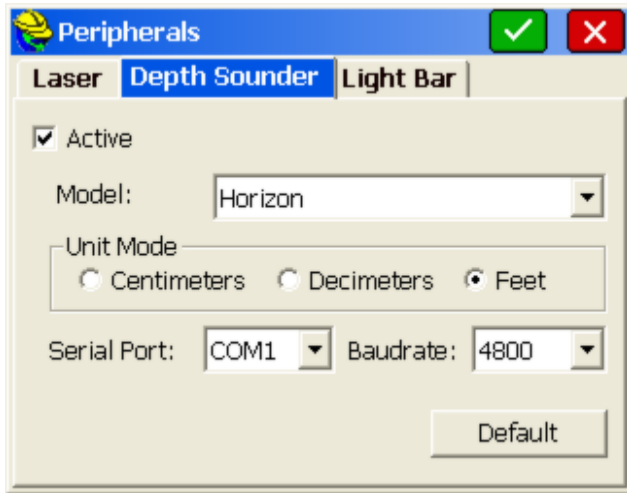

To activate the Depth Sounder, follow these steps:

1. Plug in your Depth Sounder to any of your device's unused COM ports and turn it on.
2. Enter the **Peripherals** menu, and select the DEPTH SOUNDER tab, as shown above.
3. Check **Active**
4. Select the Type of Depth Sounder you are using.
5. If the Unit Mode radios are not grayed, you will have to set the units to correspond to those output by the depth sounder.
6. Specify the Port the Depth Sounder is plugged in to.

Light Bars

Currently supported light bars are Mikrofyn and Apache. Light bars can be used with either GPS or total stations to provide prominently displayed direction arrows, when staking out a polyline/centerline, or in the Elevation Difference routine, when trying to cut or fill toward a target elevation.

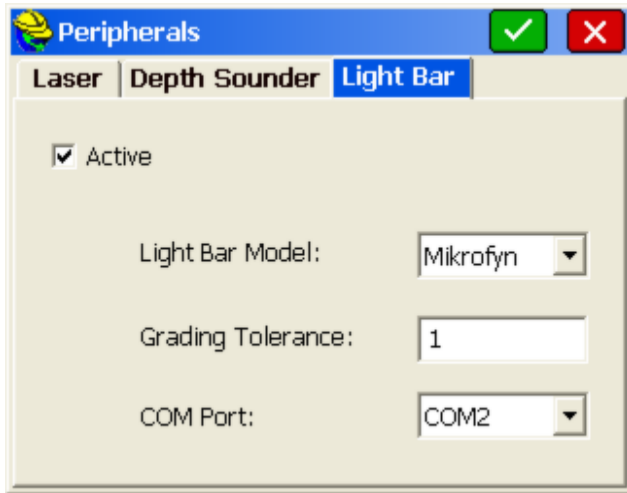

To activate the light bar, follow these steps:

1. Plug in the light bar to any of your device's unused COM ports and turn it on.
2. Enter the Peripherals menu, and select the Light Bar tab, as shown above.
3. Check **Active**
4. Select the Type of light bar you are using.
5. Set the **Grading Tolerance** to the maximum permissible deviation from the target path or elevation.
6. Specify the Port the Light Bar is plugged in to.

About SurvCE

This command allows you to view information about Carlson SurvCE and your registration.



Change Registration

The Change Registration button will open the SurvCE product registration dialog box. This dialog will allow the user to register SurvCE.

SURV

This chapter provides information on using the commands from the Survey menu.

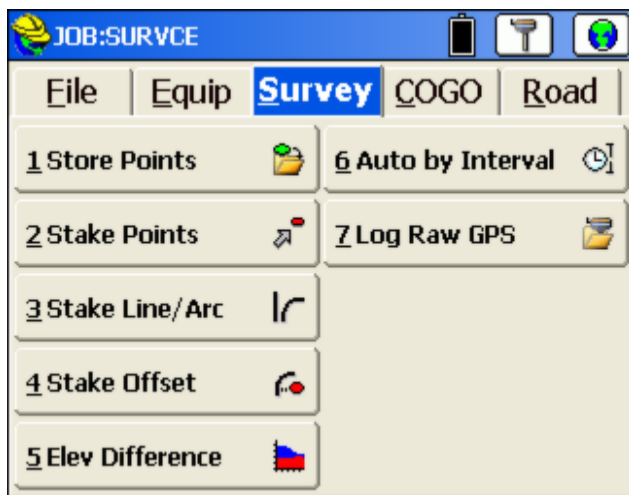

Orientation (Instrument Setup)

The instrument setup dialog is displayed upon entering every active survey routine, unless "Prompt for Total Station Setup" is clicked off within **Configuration**. You also go directly to the Orientation screen whenever you click the tripod icon in all survey and stakeout routines. So if "Prompt for Total Station Setup" is clicked off, but your occupied point has changed, then within the survey routine, tap the tripod icon (lower right) to update the occupied point and other setup information.

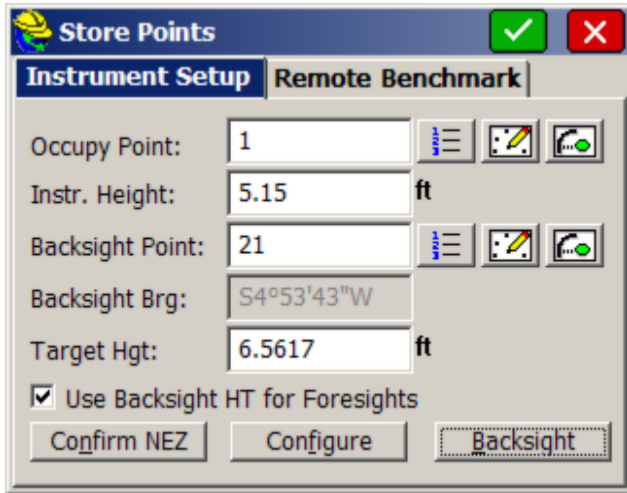

When simply confirming the backsight information, if the OK button (green checkmark) is active, you can simply press Enter or click OK to move on to the active survey screen. If the OK button is grayed out, that means the program has detected a new occupied point (or the first one of the survey). Then you must click the Backsight screen and take an angle and/or distance measurement to the backsight.

When configured to robotic total stations, the **Tripod** icon takes you first to the robotics control screen for quick adjustments, and then back to more foresights. From there, you can tab to the backsight screen to access all of the backsight functions, then easily return when you are finished to the Foresight Screen.

- **Occupy Point:** You can manually enter the occupied point ID (occupied/setup point) or click the **List** icon and select the point from a list of points. You can also choose the point by clicking the **Map** icon and selecting the point from the map itself by tapping a specific point. Finally, a third icon offers the ability to occupy a station and offset on a known horizontal alignment, without knowing a point number.

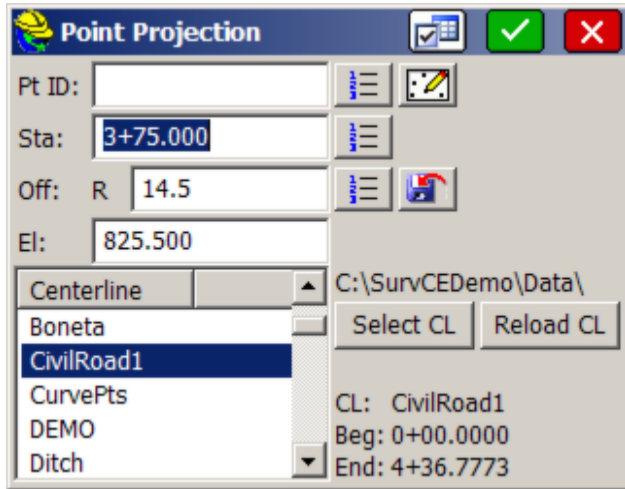

In the Station/Offset method, you must load a horizontal alignment (centerline) file and then specify a station and offset. If you click the "store to disk" icon, it will store the station and offset and after clicking OK in this dialog, you will be prompted for a description, and the next available point will automatically be assigned. If you enter a station and offset that is equivalent to a known point, that point will populate in the Pt ID field. And if you enter a point in the Pt ID field, it will confirm to you the station and offset. In road work, this option can be used simply for confirmation of the correct station and offset for any entered point.

- **Instr. Height:** This is the height of the instrument from the center of measurement (typically middle of the lens) to the tack in the hub, or ground elevation over which the instrument is set. Units for the instrument height will be set according to the options in **Job Settings**. The units for the job are displayed (ft, lft or m). If you brought a feet and inches tape to the field, and you are set in decimal feet units, you can enter the instrument height as 63" (in which case 5.25 will be computed) or as 5.6.3.8 (5 feet 6 and 3/8", in which case 5.5313 will be computed).
- **Backsight point:** Here you enter your backsight point ID, or pick it from a list or from the map itself, using the icons to the right. You can also click the station and offset icon, as with the occupied point. A backsight point ID is required, even if you choose to enter an azimuth or bearing only.
- **Backsight Bearing or Azimuth:** This displays the bearing or azimuth between the two entered points, when both points have coordinates. If **Angle Type**, in **Job Settings**, is set to **bearing**, then a backsight bearing will appear. If set to **azimuth**, then the backsight azimuth is shown. (Azimuth should always be used with a 400 circle/gons configuration). When both point IDs have coordinates, the backsight is fixed and predetermined and therefore the bearing/azimuth field is disabled since it cannot be altered. However, if the backsight point has no coordinates, then you must enter a backsight bearing or azimuth, which will be used to calculate the null or zero coordinate point ID.

- **Target Height:** This is the height in feet or meters (depending on your configuration) of the target, from ground elevation to the center of the lens for example. Even if working in English units, you can enter a 2 meter target height using 2m. This converts to 6.5617 feet automatically after you press Enter.

Note: The backsight target height will default to the previous backsight target height on future setups. The foresight target height is kept distinct and will default to previous foresight target heights, but will not automatically match the backsight target height. If you prefer to survey by setting the prism pole to a fixed height for both backsights and foresights, be aware that you will have to put in 2 initial target heights: one for the first backsight in the backsight screen and one for the first foresight in the foresight screen, in order to get both “remembered” values established.

- **Use Backsight Ht for Foresights:** This option will link the backsight height and the foresight height to accommodate the use of a single prism for both the backsight and foresight readings, rather than a fixed tripod at the backsight and roving pole scenario.
- **Confirm NEZ:** This option will display the full coordinates and description of both the setup and backsight points. By default, the Setup coordinates will be displayed. You can tab to the backsight coordinates. Press Enter or tap **OK** to exit this dialog.
- **Configure:** This accesses the **Configure** screen for a variety of condition or settings changes (e.g. Hgt/Desc prompt on save).
- **Backsight:** Continues to the **Take Backsight** screen.
- **OK or pressing Enter:** Continues straight to the **Foresight** screen. If **OK** is not highlighted and not ghosted, pressing **OK** will still go to the Foresight screen, even if Enter does not.

Orientation (Backsight)

The backsight dialog has **Setup** and **Results** tabs showing the results of a measurement to the backsight.

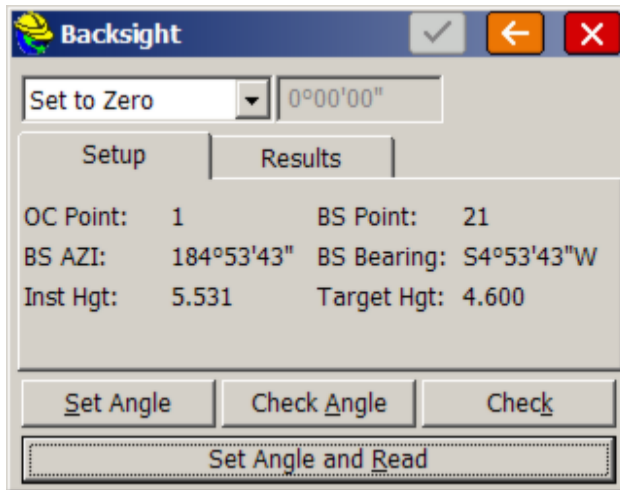

- **Set Angle Option List:** There are three options for setting the reference angle in backsight. They are found in the options list at the upper left of the Take BS screen:

Set to Zero: This is the most commonly used option. A message is sent to the instrument to set it to zero, then the backsight is taken at a zero reference angle. Angles are then typically turned to the right from zero.

Set to Backsight Azimuth: In this scenario, the backsight direction in the gun is set to the azimuth of the backsight. For example, if the backsight azimuth is 180 degrees, then an angle to the right of 10 degrees would read 190 degrees from the instrument. This is useful in underground mine surveying because it ensures that the readings displayed by the total station always refer to true azimuth. Some surveyors are “azimuth” surveyors and others prefer “set zero”.

Use Current (Do Not Set Angle): Uses whatever direction reading is already in the instrument.

- **Set Angle and Read:** This button will set the horizontal angle and read the distance to the backsight. The program defaults to the **Set Angle and Read** option (the large, lower button), on the assumption that in most cases, you will be taking a distance measurement to the backsight.
- **Set Angle:** This button will only set the horizontal angle. If you are just backsighting an object or plumb bob without a measurement, choose **Set Angle**. You can tap **Set Angle** on the screen or, using the keyboard, enter ALT-S. (**Note:** On most buttons, the underlined letter in the name is the hotkey which, in combination with the ALT key, will access the function of the button. On this menu, for instance, ALT-A would go to **Check Angle**.)
- **Check:** This enables the surveyor to determine whether the instrument has drifted off the point. Based on what is presented here, the surveyor may decide to reset the BS angle, or to actually re-level and re-shoot the BS point. More commonly, you would do a **Check Backsight** after taking a large set of

foresights. You may want to be sure that you haven't bumped the instrument or experienced settlement in the tripod legs.

- **Check Angle:** This button will simply read the angle currently in the instrument and compare it to the reference angle. Choose **Check Angle** to re-sight on the backsight and obtain an angular error report (no distance comparisons are made).
- **Turn to BS:** With robotic total stations, you have the option to automatically turn to the backsight. This button will turn the instrument to the previously set backsight angle so that a **Check Angle** or **Set Angle** can be performed. Once you press **OK** to go back to the foresight screen, the instrument will automatically prompt if you want to return to the previous foresight position.

Whether in a conventional or Manual Total Station configuration, pressing **Set Angle and Read** or pressing **Enter** will cause a backsight to be taken. In Manual Total Station configuration, a dialog will appear for you to manually input the angle and distance measurements.

Pressing **Enter** or **OK** completes the backsight setup and leads to the foresight screen, where shots are taken, readings are presented, and points are plotted graphically.

Types of Total Station Backsights - Handling Missing Information

The SurvCE backsight procedure will allow last minute entry of the backsight coordinate values if none are found, or will calculate the backsight coordinates using the azimuth and distance of the measurement. If both the Station and Backsight have coordinates (non-zero northings, eastings and elevations), the backsight azimuth is computed, and the coordinate values are not altered.

Known Station and Backsight Azimuth to Backsight Point of Unknown Coordinates

In the case that the coordinates of the station are known and you shoot a backsight point of unknown coordinates, a backsight point will be calculated. Note that when a zero-coordinate backsight point is encountered, the program will prompt the user to "Enter Coordinates or Use Azimuth". This prompt appears only when the **Use Azimuth** option has been selected. If you choose only to **Set Angle**, the backsight point will not be calculated, but is still a viable entry in the raw file. Some raw file processing programs make use of this backsight point with zero coordinates as a backsight azimuth reference. It is recommended that you use distinct new point IDs for all foresight points. Don't re-use a backsight point ID that served as a "dummy" point to initiate the "set zero" backsight, unless you plan to re-use it for the same backsight again.

Orientation (Remote Benchmark)

This is a command for total station applications only, in which the elevation of one or more remote, but known, points is used to compute the elevation of the occupied Station. The **Remote BM** tab is the 2nd to the right in the Backsight screen. The main screen is shown below.

Sideshot/Traverse [✓] [✕]

Instrument Setup **Remote BM** Robotics

Occupancy Point: 6 [Read]

Instr. Height: 5.0000 ft [Results]

Oc. Pt. Elev: 101.97000 ft [Store]

BM Point: 6 [List] [Edit]

Target Hgt: 4.7 ft

BM Elev: 101.97 ft [Confirm NEZ]

- **Read:** You have the option to transfer the elevation from a single benchmark by taking a reading on it, any number of times, in any face. You may also use multiple benchmark points, any number of times, in any face. If you turn on Direct and Reverse for Resection in **Configuration, Sets** tab, robotic instruments will perform a D&R automatically for remote elevation readings as well.

Results [✓] [←]

Average Station Elevation: 101.9163

BMark	BM Elevation	Calc dZ	Meas dZ	Stn Ele
6	101.9700	0.0000	0.0539	101.9163
6	101.9700	0.0000	0.0535	101.9163

- **Results:** The readings taken on the benchmark are reported in the **Results** dialog. All of the readings taken will determine an average instrument point elevation.
- **Store:** Click **Store** to update the instrument point elevation. A store point record will be recorded to the raw data file.

Orientation (Advanced Occupation)

The Advanced Occupation command allows for multiple points to be used to orient the backsight, conducting a least squares analysis on all measurements taken. It is sometimes referred to as the "Multiple Backsight" command. The Advanced Occupation command will also locate the occupied point if sufficient measurements are taken, allowing for the storing or overwriting of the occupied point coordinates. The appearance of this option in the backsight screen is itself dependent on turning on the "Show Advanced Backsight" option within Configuration. This leads to a third "tab" option within the Store Points, Stake Points and other commands involving backsights, called "Occupation", short for "Advanced Occupation".

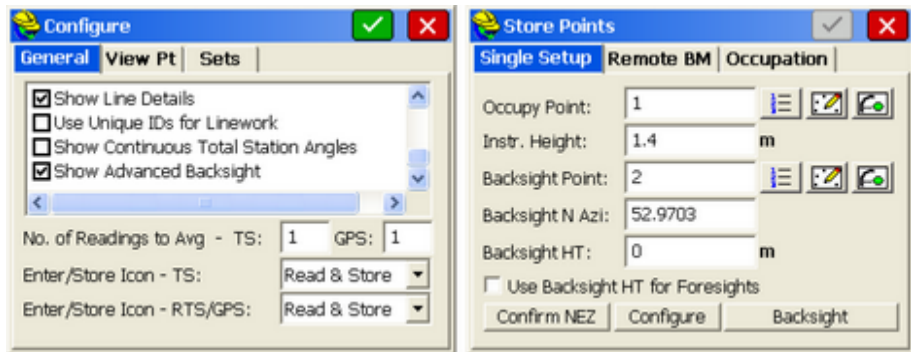

Although standard backsight procedure may be to take one or more readings to a single backsight, the Advanced Occupation command allows multiple readings to be taken for the backsight, to points identified in advance, leading to a "best fit" backsight orientation computed by least squares methods. Consider the graphic below, showing a proposed occupied point (tripod) and three known point IDs as originally surveyed and precisely located based on a due North backsight.

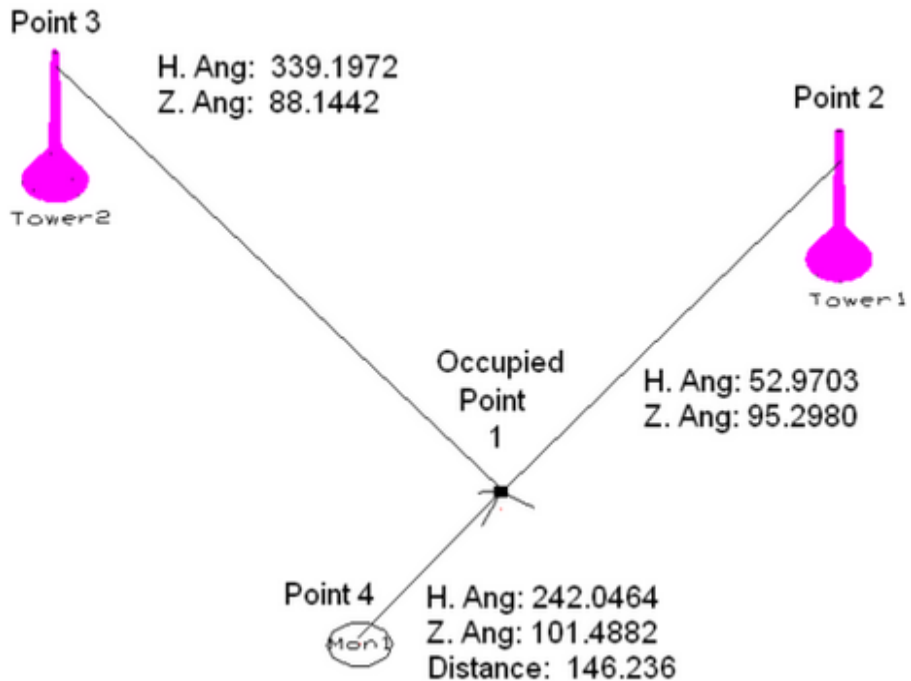

Although it is sufficient to backsight to point 4, from known occupied point 1, taking additional measurements to point 2 and point 3 can lead to an "averaged" backsight and best fit orientation. Furthermore, if point 1 is not known, the position can be determined by the least squares calculations within Advanced Occupation, similar to a resection. Even if point 1 is known, if the calculated position is saved and not overwritten, then a redundant position for point 1 can be stored to the raw file, leading to more precise calculation of point 1 by Network Least Squares methods using office software, such as Carlson SurvNet.

In the above example, points 2 and points 3 can be considered to be towers and sighted for angle only measurements, while the measurement to point 4 would include both angle and distance. Furthermore, the data for these points will be recalled from a control file, so that they can be re-used on multiple jobs. And in this example, the angles will be recorded in gons/grads, or the "400 circle", with distances in metric. In the new file (Ville2.crd), a control file which we will call RadioTower.crd is referenced within Job Settings, Options tab. Note that it is not necessary to extract the backsight points from a control file. However, in developed areas with known control points, it is a useful technique to store control points to a distinct file so they can be easily recalled in all new jobs. The elevations on the radio tower points represent only the vertical positions originally measured, and can be ignored when used in Advanced Occupation (or in Resection). The radio tower points will be used only for their north and east coordinates.

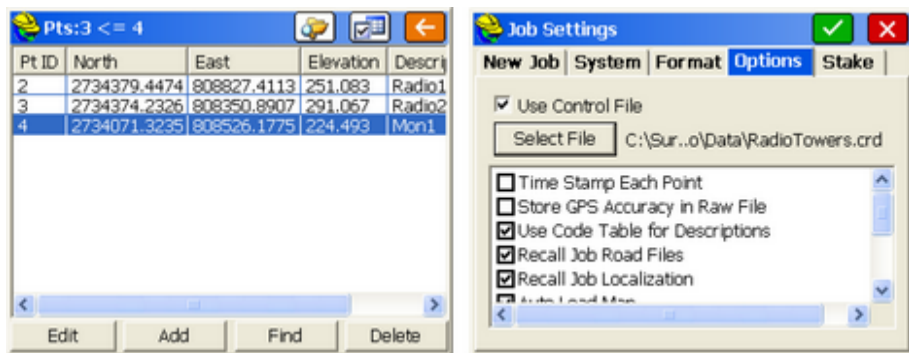

The Advanced Occupation command can even be run from a file containing no coordinates, assuming backsight points can be referenced from a control file. Begin by selecting the command Store Points in the Surv Menu, establish point 1 as the occupied point, 2 as the backsight and enter the correct target heights (0 for the radiotower point 2). Then click to "Occupation". The first screen appears below:

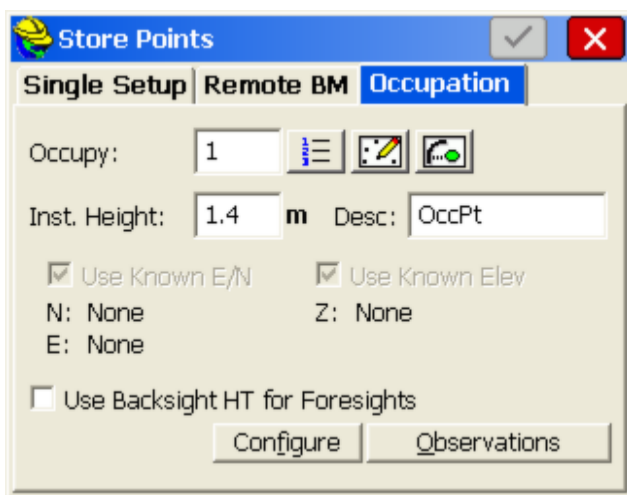

If the occupied point is not known, as in this case, then N, E, Z values appear as None. If the point is known, then the N, E, Z values appear with their coordinates, and you must decide whether to "Use Known E/N" and "Use Known Elev" before proceeding. The next step is to click the Observations button. Note that if a previous list of targets was created, you will be prompted to re-use the target list. In any case, you proceed to the following screen:

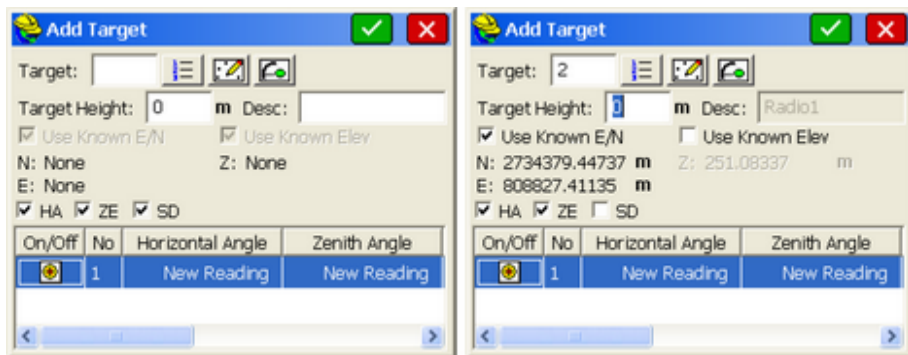

Entering point 2 as a target leads to presentation of the coordinates for 2. Since this is an "angle-only" measurement, turn off the slope distance "SD" option and turn off the "Use Known Elev" option. The "Zenith Angle" option is also irrelevant but can be left on or off. The goal of Observations is to load in advance all targets that will be used for the multiple backsight measurement. So if in this case, our goal is to backsight control points 2, 3 and 4, we would select those point IDs. Note that if the current job contains no points 2, 3 and 4, then you can simply enter them as targets, and the program will automatically find them in the control file where they don't exist in the current job. However, if the current job contains points 2, 3 and 4, you would need to use the "FromList" icon to the immediate right of the Target prompt and then select the "Control" file option at the top of the List Points dialog as shown below. This ensures the selection of point 2 from the control file.

Pt ID	North	East	Elevation	Desc
2	2734379.4474	808827.4113	251.083	Radio
3	2734374.2326	808350.8907	291.067	Radio
4	2734071.3235	808526.1775	224.493	Mon1

The process of loading, in advance, all targets to be used is then repeated for points 3 and 4. Additional points are added by tapping the "Add" button shown below:

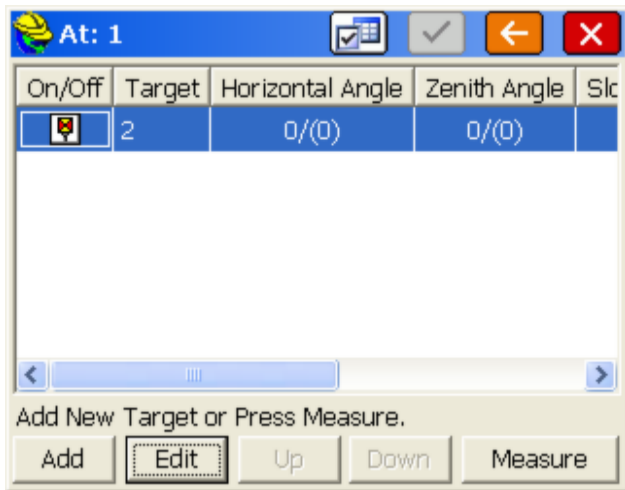

In this example, we would add points 3 and 4. Note that for point 4, a target height of 2 meters will be used, and the slope distance reading and elevation of point 4 will also be used in the calculation.

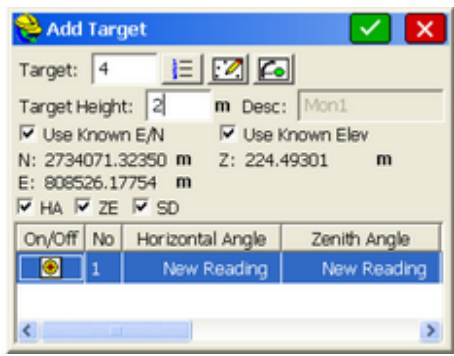
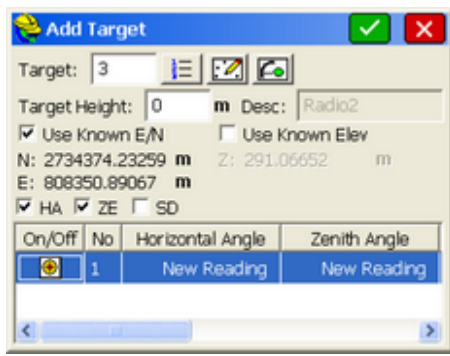

When distance measurements are involved, the prism offset can be entered distinctly for each measurement.

Target: 4

Target Height: 2 m Desc: Mon1

Use Known E/N Use Known Elev

N: 2734071.32350 m Z: 224.49301 m

E: 808526.17754 m

HA ZE SD

Set	D/R	Target Type	Prism Offset	No
Value	New Value	Prism	0.0 (circle)	1

When the entire list of targets has been entered, you then select the target to measure first (eg. point ID 2) and then tap "Measure".

At: 1

On/Off	Target	Horizontal Angle	Zenith Angle	Slo
<input checked="" type="checkbox"/>	2	0/(0)	0/(0)	
<input checked="" type="checkbox"/>	3	0/(0)	0/(0)	
<input checked="" type="checkbox"/>	4	0/(0)	0/(0)	

Add New Target or Press Measure.

Add Edit Up Down Measure

You will be prompted to turn to the target in direct face, and take the reading. Assuming you set zero on the instrument to the backsight to point 2, the following measurements may be entered:

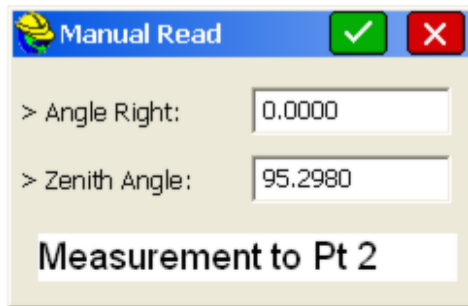

Manual Read

> Angle Right: 0.0000

> Zenith Angle: 95.2980

Measurement to Pt 2

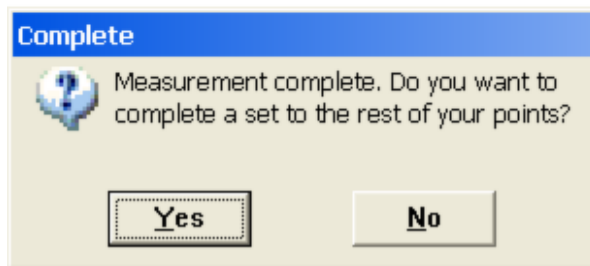

Complete

Measurement complete. Do you want to complete a set to the rest of your points?

Yes No

After the first measurement is taken, you are asked if you wish to complete the set to the rest of the points. Click Yes. Then you can take readings to the remaining points, as shown below:

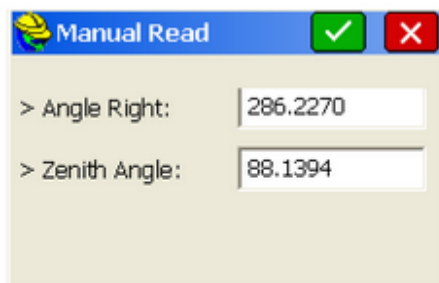

Manual Read

> Angle Right: 286.2270

> Zenith Angle: 88.1394

Measurement to Pt 3

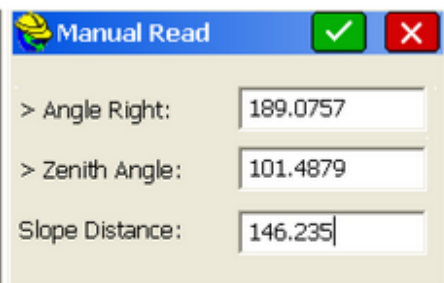

Manual Read

> Angle Right: 189.0757

> Zenith Angle: 101.4879

Slope Distance: 146.235

Measurement to Pt 4

When all direct measurements are taken, you will be asked to continue the measurements in reverse face. If you do not wish to do both direct and reverse, you answer N and then continue. The program will announce, "Set Complete". You will return to the list of targets and can then click the green check mark to continue:

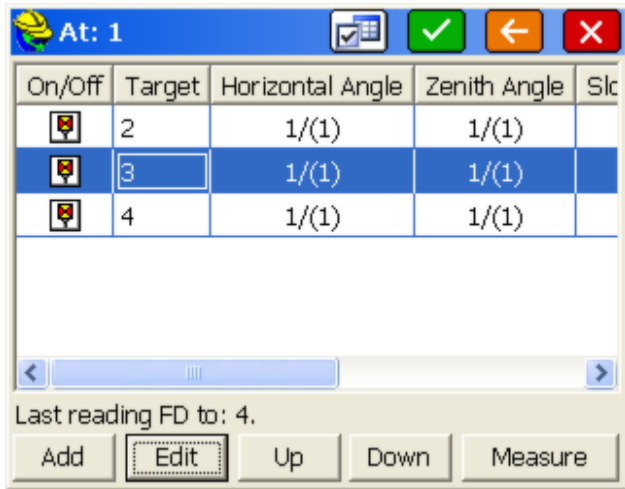

Here, you will either be led to the results screen showing the successful calculation, or it will report, "Unable to retrieve solution results". In the case above, the computed results are shown below:

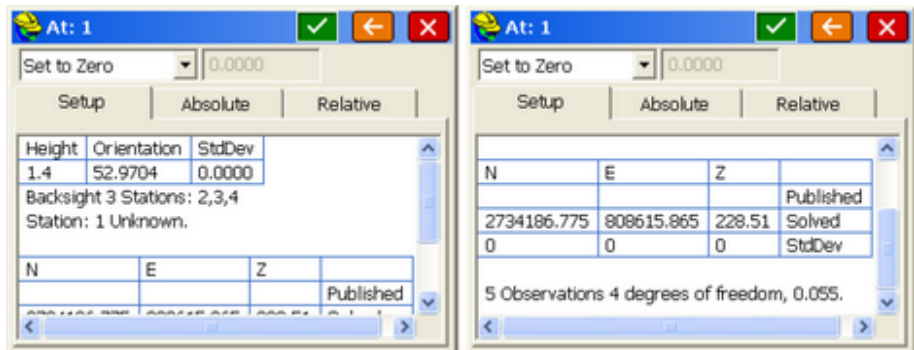

Note that the "averaged" backsight orientation is 52.9704, although by setting 0 to point 2, the mathematically computed backsight reading would be 52.9703. An added feature of the Advanced Occupation routine is the calculation of the occupied point coordinates. In this example, the original point coordinates for point 1 are: N 2734186.7757, E 808615.8663, Z 228.511. The degrees of freedom is the difference between the number of observations and the number of unknowns. The degrees of freedom increase if more redundant measurements are taken, such as reverse readings or multiple distance readings, and 20+ degrees of freedom would indicate strong statistical confidence. When the OK (green check) button is clicked, you have the option to save the occupied point, in which case you can overwrite the current occupied point, save to a new point ID, or save to the raw file only. Then you continue into the Store Points command or other commands and can take new measurements.

If you have taken both direct and reverse readings, the report includes data on the collimation of the instrument, provided that the collimation option is turned on

within the settings option  within Advanced Occupation. The Settings option includes the following settings:

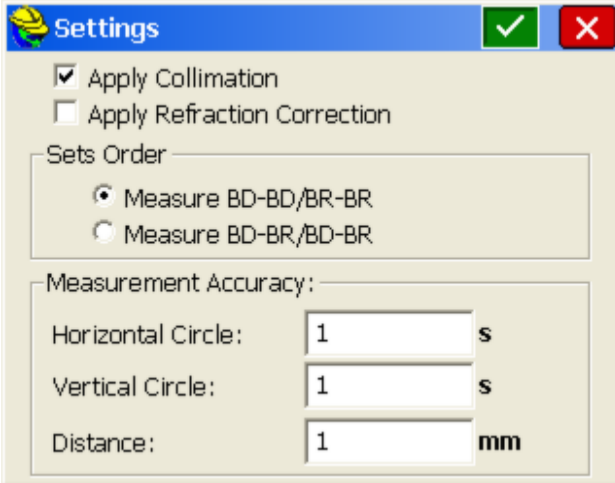

Settings

Apply Collimation
 Apply Refraction Correction

Sets Order

Measure BD-BD/BR-BR
 Measure BD-BR/BD-BR

Measurement Accuracy:

Horizontal Circle: 1 s
Vertical Circle: 1 s
Distance: 1 mm

- **Apply Collimation:** Leads to a report on the collimation of the total station instrument provided that both direct and reverse measurements are taken to the same foresights.
- **Apply Refraction Correction:** This option should be selected only if the instrument itself does not automatically apply refraction correction in the reported readings.
- **Sets Order:** The two choices are to take ALL backsight direct readings first followed by all backsight reverse readings (BD-BD/BR-BR) or to be prompted for the reverse reading following each backsight direct measurement (BD-BR/BD-BR).
- **Horizontal Circle Accuracy:** Estimation of accuracy is used in least squares calculation.
- **Vertical Circle Accuracy:** Estimation of accuracy is used in least squares calculation.
- **Distance Accuracy:** Estimation of accuracy is used in least squares calculation.

Prism Offsets can be changed for each total station measurement taken that includes a distance reading. In the above screens, the instrument was set to "Manual Total Station". When set to an actual field instrument, the "Target Settings" button appears.

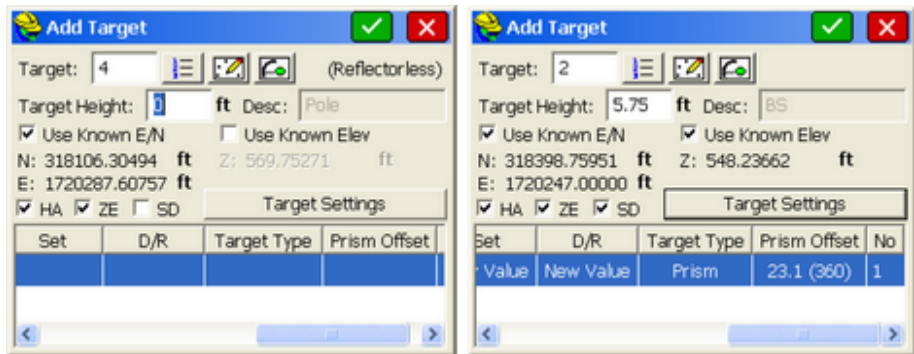

A reflectorless reading, above left, contrasts with a Leica 360 prism reading, above right. If measuring angle-only readings to objects such as radio towers and church steeples, you can stay in prism mode but just click off the SD (slope distance) component. Click Target Settings and you can set the prism offset from a list of options. Target type is "Prism" or "Reflectorless".

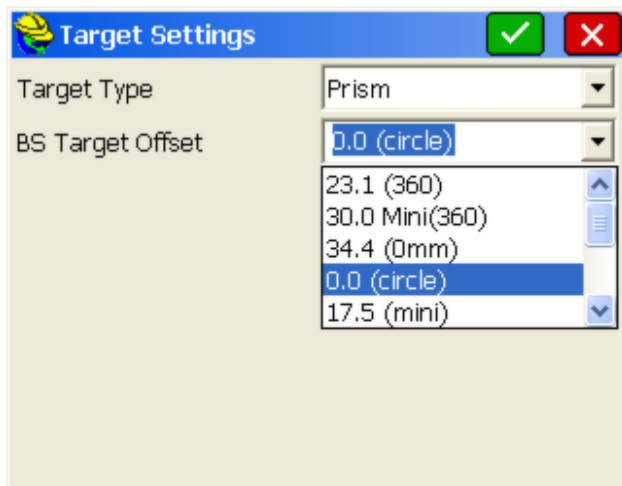

After cycling through all targets and being prompted for reverse readings (optional), you are returned to the target list. If you highlight a target and click Measure again, you are in effect launching another set of readings. You will be prompted as shown below:

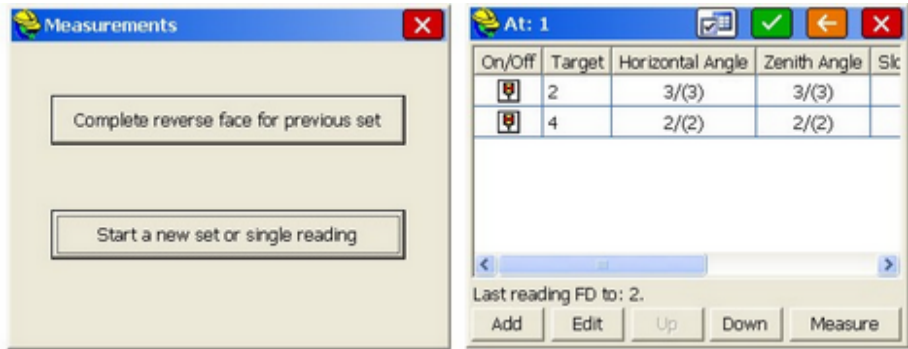

After completing a set, if you click Measure for measurements, you can accumulate multiple readings which can vary from target to target, depending on whether you choose to skip certain target readings, do direct only, etc. Each direct and reverse measurement counts as a reading. You can turn all readings to a target on or off (in the screen, above right) and by clicking Edit, you can turn any individual reading to a target on or off, as shown below:

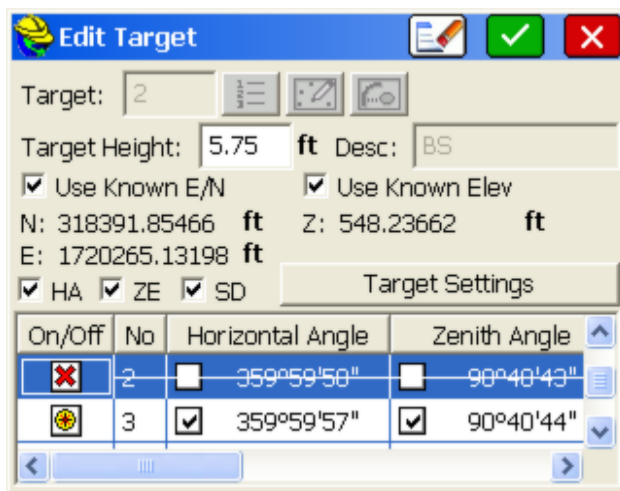

When the process is complete and you exit Advanced Occupation, the program adjusts the backsight orientation with the following prompt, after which it announces "Operation Complete. Angle Set."

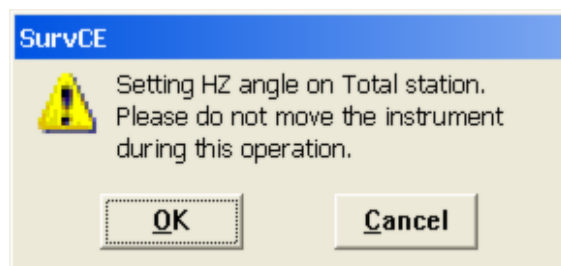

For any reading, within the Edit option, you can delete aspects of the reading. If you want to delete the entire entry in the list of targets (for example, you want to delete target 4 from the list), then select 4 and click Edit, which brings you to the screen in the lower left, then click the eraser icon at the top of the screen and click on "All" (lower right).

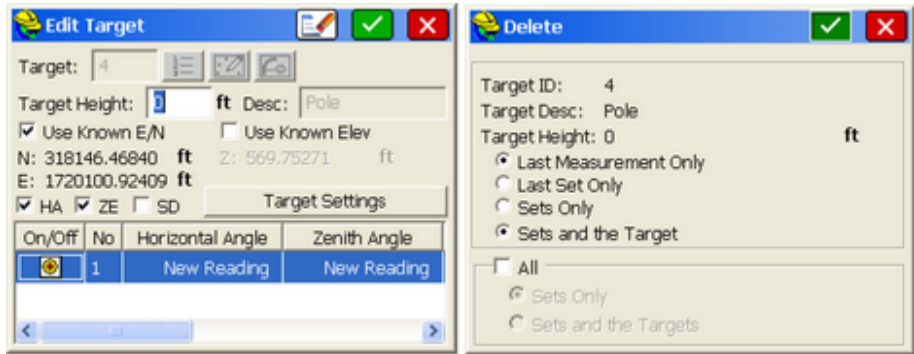

For robotic total stations, the instrument will turn automatically to the direct and reverse positions for the selected targets, provided that within Configure, Sets tab, the "Turn to Reverse Face" and "Robotic Set" options are selected as shown below:

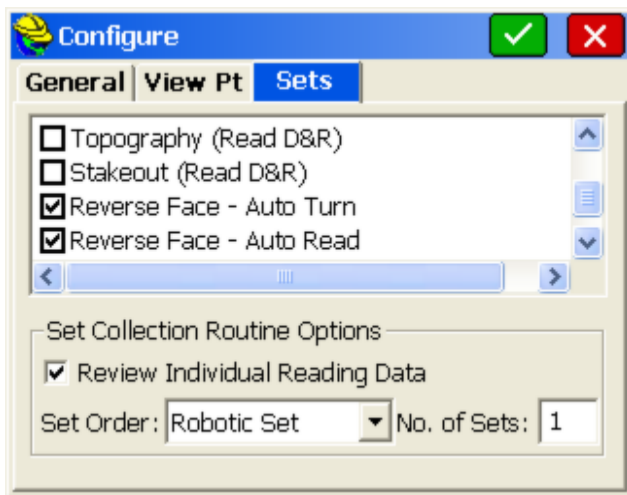

Orientation (Robotics)

The term "Robotics" applies to Geodimeter, Trimble 5600, Leica, Sokkia and Topcon robotic instruments. The **Robotics** tab has some variations per equipment type.

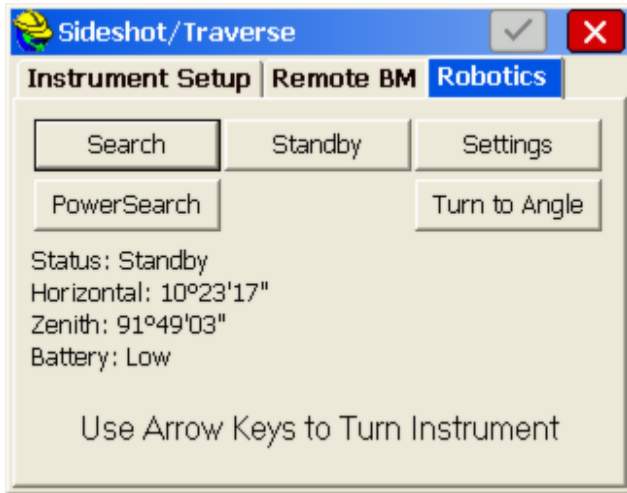

Arrow Keys for Joystick

ALT-J will take you directly to the robotics dialog from elsewhere in the program. The arrow-key motion is sometimes referred to as the Joystick Speed.

Leica: Tapping once in the direction you want (e.g. up) causes the instrument to move slowly, two taps medium, and 3 taps fast speed. Tapping the other direction (e.g. down) stops the movement.

Geodimeter/Trimble: Press the arrow key once. After a small delay, the instrument will move an incremental amount. Do not rush too many presses as they all will be completed.

Topcon: Holding down the arrow keys on the keypad of the CE data collector allows you to move the base instrument up and down, left and right. When you release the key, the motion stops.

- **Search:** This button will initiate a search to look for the prism or reflector. For Leica, **Search** initiates an ATR search. Pressing the **Search** or **Quick-Lock** buttons will lock the instrument to the prism and put the instrument back into tracking mode.
- **PowerSearch:** For Leica, the **PowerSearch** option will conduct a fast search, typically less than 10 seconds. **PowerSearch** will find the prism regardless of the original direction the instrument is pointing.
- **QuickLock:** Topcon has an additional search option called **Quick-Lock** which appears when configured for Topcon 800/8000 Remote using RC2. A **Quick-Lock** search will find the prism in less than 15 seconds.
- **Standby:** This button takes the instrument out of tracking mode. This is useful, for example, in allowing the user to set the prism pole down to drive a stake.
- **Turn to Angle:** This button opens an additional dialog that prompts you for the angle to turn (which can be entered, picked from the Map, or

point-based). See the figure below. You can turn to a known point number or to an entered horizontal and zenith angle using **Turn Angle**. When enabled, the **Search After Turn** option, searches and locks on a prism after turning the angle (potentially changing slightly the computed angle). **Change Face** reverses the face. The lower three buttons (**Turn Left 90**, **Turn 180** and **Turn Right 90**) are common angle turns and minimize user entry when needed.

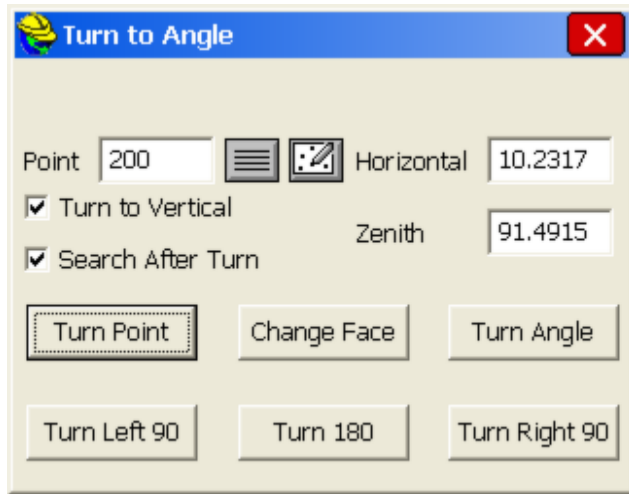

- Settings:** This button leads to a series of settings screens that allow you to dial in the speed of motion, range of motion, and other factors governing arrow-key driven movement and automatic searching.

Store Points (TS)

This command is designed for total stations and manual entry. It is the principal data collection routine with total stations. **Store Points** interacts with numerous settings, including the feature codes that will draw line work. All settings in **Configure Reading** will impact **Store Points**, including the Number of Distance Readings, Average Direct & Reverse, Hgt/Desc Prompt on Save, Angle Only in Reverse Face and Function of Enter Key. See File, Feature Code List, for discussion of drawing linework, symbols, Line Details and Point Details (option to re-measure existing points).

Foresights

The **Foresight** screen is entered automatically after exiting the **Backsight** screen. In the backsight screen, if the green checkmark ("OK") is active, you can go directly to the Foresight screen by pressing Enter or clicking the icon itself. And if you turn off "Prompt for Total Station Setup" within **Configure**, you go directly to the foresight screen if there is already a valid backsight. There are two major types of Foresight Screens: (1) Standard Total Station, (2) Robotic Total Station. See the *Store Points (GPS)* section of this manual for more information on GPS. Only total station screens will be discussed here.

Standard Total Station Foresight Screen

Store Points (standard sideshots and traverses) can be run in either full graphics mode or full text mode. The Text screen is accessed by tapping the helmet in the upper left and selecting Text. To go back to graphics, click the helmet and select Graph. Graphic backgrounds can include linework that you create yourself using commands such as PL and 2DP and O2 (offset) in the Map view. Graphics can also include drawings that you import from DXF using the command IDXF (“in” DXF) found in the Map view of SurvCE. When you exit SurvCE, this linework can be configured to “save on exit” and stay associated with your point file. Note that linework drawn by feature codes or IDXF is on layers which can be “frozen” (hidden) or “thawed” (shown) by the **Layer** command under **View** in the **Map** screen. The Text and Graphic screens are shown below.

The screenshot shows a window titled "STORE PTS" with a battery icon and a close button in the top right. The data fields are as follows:

Pt: 47	OP Pt: 1	BS Pt: 21
HT: 4.6	HI: 5.0000	HT: 4.6000
	BS Brg:	S4°53'43"W
AR: 245°35'11"	N:3474.5593	
ZA: 89°34'07"	E:4997.4930	
HD: 103.4371	Z:848.5688	
Desc: eop		

Below the data fields is a grid of six buttons:

CONFIGURE	TRAVERSE	READ
BS/SET	OFFSET	STORE

Enter saves the measurement immediately. If you do a Read, you can review the data within the Text view. If you re-enter the rod height, it re-calculates the Z elevation of the measured point. As you enter the description, a pulldown appears of your Feature Code List or previously entered descriptions. As each letter is entered, such as "e" for edge of pavement, every description beginning with "e" or "E" appears, enabling quick selections. Some users prefer the text screen to take readings because of the larger buttons and text size. The program remains in the Text mode until Graphic mode is chosen again.

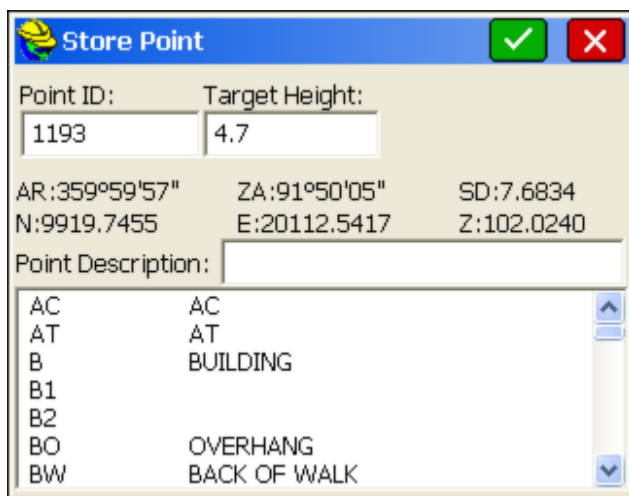
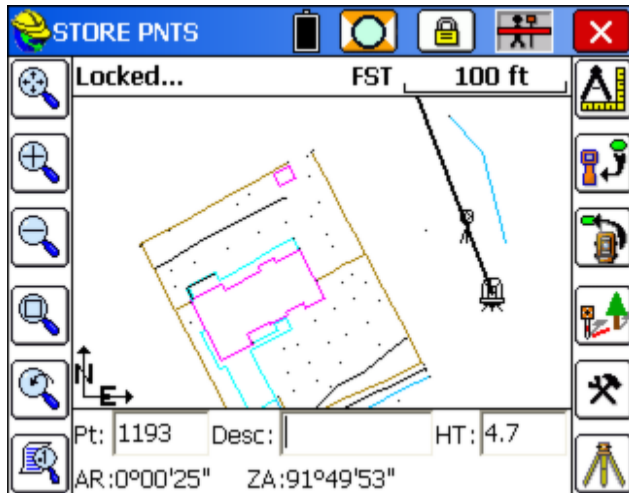

Unless the **rod hgt/description** prompt is enabled, the **Store Points** screen is designed to “quick-store” points, where the user is expected to enter, ahead of time, the correct description and rod heights in the edit boxes shown at the bottom of the dialog.

Note: SurvCE is designed to produce a 1 keystroke point store, by pressing Enter. If you experience more prompts storing a point, it is because you have certain settings active that cause additional prompts. These settings include 2 options within Configure (Prompt for Height and Description, Prompt for Point Notes), Store FCL Only within Feature Codes, Special Codes, Settings (will prompt if description does not match a feature code), the use of GIS attributes as set in Feature Codes, or the use of "Read or Store" rather than "Read and Store" within Configure. "Read or Store" will turn the first Enter into Read (to review the shot) and the second Enter into Store. Set to "Read and Store" with no Prompt for Height/Description, points are typically stored as fast as you press Enter.

- **Sokkia-Style:** The SDR33 and earlier SDR data collectors have a convenient concept for “Store Last, Read Next”. In this method, you get your descriptions set up and take a shot. The reading is displayed at the bottom line of the screen. You examine it, satisfy yourself it is correct, move to the next point, and take another shot. This was done on the SDR collectors with the **Read** key, but with SurvCE, can be accomplished with **Enter**.
- **Normal Foresight Style:** The most typical method is the "Read *and* Store" procedure as set in **Configure**. This takes a one keystroke measurement. But you must remember to enter the height and description ahead of time, before pressing Enter. If you want an "after-shot" chance to change the height and description, turn on "Prompt for Height/Description Prompt" within **Configure**. The **Enter** key can also be used for Read First, Store Later. This is the “Read *or* Store” version. Your first **Enter** is a read, only (like pressing **R** or entering ALT-R). Your second **Enter** is a store, which can be followed by the **Hgt/Desc** Prompt on save. This is the most cautious designation of the use of the **Enter** key for taking shots. Note below that after the read, the point is displayed with a question mark, and the raw data is displayed. It is saved only when **Enter** is pressed again (or **S** is pressed, or even Alt S—all of which store a previous Read). In the final **Store Point** dialog (with Rod Hgt/Desc prompt turned on), you will find the Point Description field. Along with the designated Feature Code list, all descriptions entered for the current job will accumulate in the available Point Description List, allowing the user to select the text graphically, arrow key to the desired text, or highlight and select the correct text after entering the first character in the edit box. An entry of “P” goes right to all text starting with the letter “P”. Then you can select the one you want. The **Enter** key will continue on at this point.

Height/Description Prompt

When this option is turned on within **Configure (EQUIP menu)**, you obtain the full list of Feature Codes plus any descriptions you have entered that are not included in the Feature Code list. Shown below is a reflectorless shot (rod height=0) with Height/Description Prompt on.

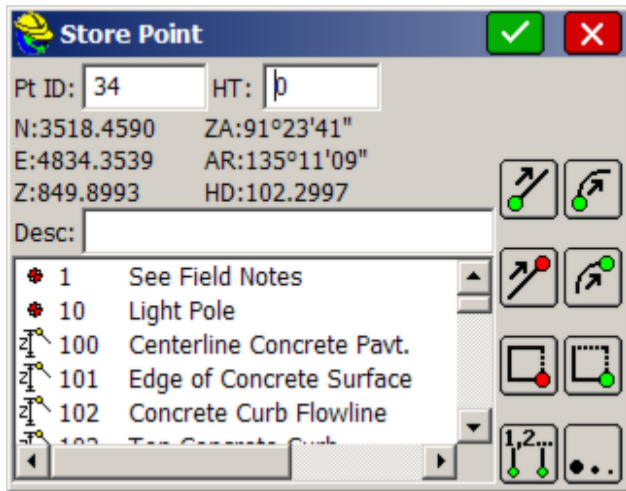

Symbols are shown as circles, and polyline features as lines. Polylines that are 3D include the "Z". As a short-cut to entering the special codes to start and stop lines, you can use the icons that appear at right. Of the 8 icons shown, going left to right starting at the top, they represent start polyline, start curve, end polyline, end curve, close polyline, close rectangle, designate specific "unfinished" active line, and "more options", leading to icons for Offset Horizontal and Offset Vertical.

Robotic Features

The status of the robot is displayed in the upper left-center, next to **TEXT** and above the Map. Status modes include:

- **Tracking:** Locked onto the prism and following it (shows the "man with pole" icon). If not tracking, there is a line through the icon.
- **Locked:** Shows the "Lock" symbol, meaning the instrument is following the prism. You can be locked and following the prism but not tracking (taking distance measurements, showing position of prism on the screen).
- **Standby:** Stopped in the last position it was in and ready to resume Tracking.
- **Searching:** Looking for the prism (shows an hourglass).
- **No Data:** Brief mode between losing the prism and beginning an automatic search.

The **search/standby** and **lock** icons let you initiate a Search after a lost lock condition, or go to Standby if currently locked (to drive a hub and stop the gun from moving), or go back to Lock, from Standby (after driving the hub). In the graphic shown above, you are in Prism Mode (as opposed to reflectorless, which would show a line through the prism). You are locked and "tracking" real-time, meaning distance measurements are being taken.

The tracking icon, takes the EDM signal on and off. With the signal on, more power is used, but you gain a lot by seeing continuous, real-time distance readings and by seeing your position on the screen, in the form of a triangle. Shots are

nearly instantaneous, but respond to the “fast-tracking” mode of the EDM (typically 10mm). If taken out of EDM Tracking, you lose your real-time movement on the screen, but measurements will respond to the accuracy of your Equipment Settings, which may call for standard or fine mode.

When a measurement is made and the instrument is locked on the target, tracking can occur (distance measurements), which then shows the target moving on the screen as a triangle. This uses battery, so "Track after reading" is a setting, which you can choose to turn on or off, found within C for Configuration (when using robotic total station drivers).

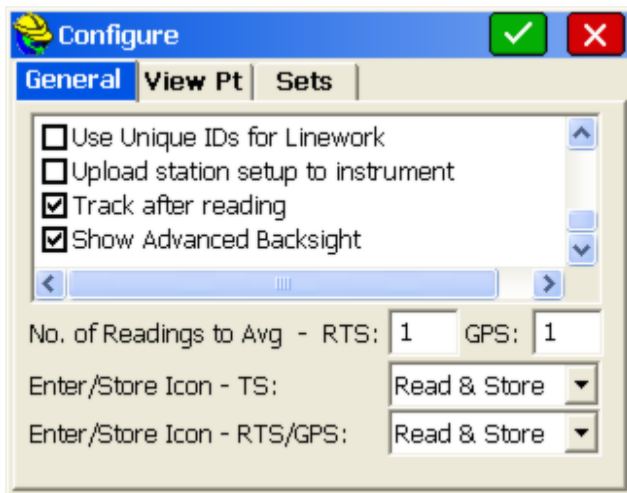

Leica robotic total station users in particular, when doing topography or as-built surveys, prefer to turn off "Track after reading", in order to save battery between measurements. Instead, they simply keep the instrument "locked" or following the prism, but not tracking (taking distances).

Note: The response to losing lock when taking foresights with robotic total stations is for the instrument to stop where it is. If you have enabled **Search when Lost Lock** in instrument settings, the instrument will start searching immediately on loss of lock. Alternately, when running remotely, you can use the joystick-arrow controls to move the instrument towards you and obtain lock again.

Store Points (TS Offsets)

Making offset points using a total station requires tapping the O/Offset button (or entering ALT-O) within the Store Points Foresight Screen. If you are set to the graphical icons in **Configure**, you would select the "offset to tree" icon. This works from both the Graphic and Text screens when foresighting. There is no distinct total station "Offset" command—it is an offshoot (literally) of standard Store Points.

The Offset command includes the Read option to take a fresh measurement, to

which the offset options then apply. Most users select O for Offset to do both the new measurement and the offset entries. However, you also have the option to apply the offset entries to the last measurement taken in Store Points. For this second alternate approach, you use the normal Store Points command to do R for Read or S for Store (or Enter to take the measurement) and then use the O for Offset command to use the last measurement (as displayed), and apply the offset options and click Store. In this second approach, if you chose R for Read and took a reading, and then selected O for Offset, you can then offset that reading with the option to store or not store the initial Read measurement. If you enter the Offset command after storing a point in Store Points, the last measurement will be used (and used for the Distance in the Distance/Angle, 2-reading option), and a new point ID will be stored. Within Offset, whenever you do a fresh, new Read, you will substitute the new reading for the one previously stored in memory. If you have no previous measurement, a new Read is required within O for Offset. So in summary, you can offset something you've already measured, or you can take a fresh measurement (typical method), using O for Offset.

The total station Offset command must be selected each time it is used. It has three options:

- **Distance/Angle** (sometimes referred to as “Shoot a Big Tree”): The Distance/Angle method requires two measurements. The first measurement is the distance, followed by the prompt to read the angle. Note that the dialog, shown in the next figure, prompts you to **Read Distance** first.

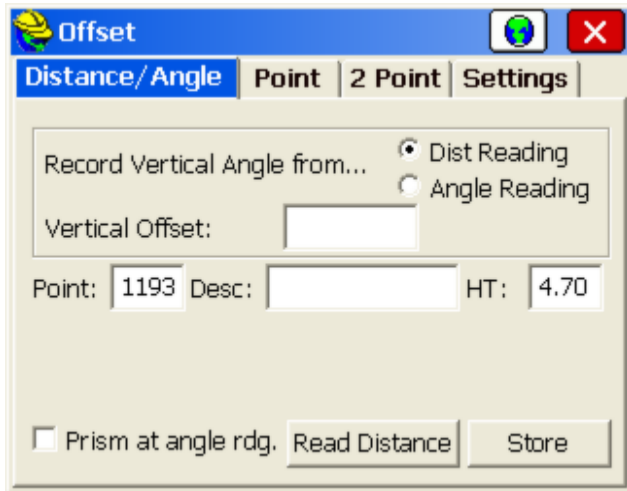

In the case of shooting a large tree, where the goal is to shoot the center of the tree, you would take a shot to the middle-side of the tree, equivalent to the distance to the center of the tree. Then you would take a second shot, as prompted, to the middle of the tree, for horizontal angle only. Note that for the elevation of the shot, you can use the distance measurement or the angle measurement (second reading), and apply the vertical offset, if any, accordingly. After both measurements are taken, the results are displayed. You are then

returned to the dialog to take your next offset.

- **Point (Plus/Minus):** The Point Offset takes a shot and deducts or adds a distance relative to the line-of-sight in all three directions (L/R, In/Out, Vertically Up/Down) using the dialog shown in the next figure.

Offset

Distance/Angle **Point** 2 Point Settings

Relative Point Facing Instrument

Left Right Value:

In Out Value:

Up Down Value:

Point: Desc: HT:

Measured: AR: 359°59'49"
ZE: 91°49'55"
SD: 7.684

- Before the shot, tap **Read**. After the shot, when the raw data is displayed in the lower left, tap **Store**. You will remain in the command until you tap **Close**.

Repeat Shots Using Offsets

When taking multiple measurements in traffic or other conditions where you must move away quickly, one technique is to use the Offset button in Store Points, and then the Point method. You do a Read and enter 0 for all offsets, then Store. Then change the description and tap Store again (no additional Read is necessary), and a second point with a different description (or rod height, or offset) is stored. Some office software programs require distinct readings on the same point to process multiple descriptions, in which case the use of Offsets to store multiple readings with one field measurement is recommended.

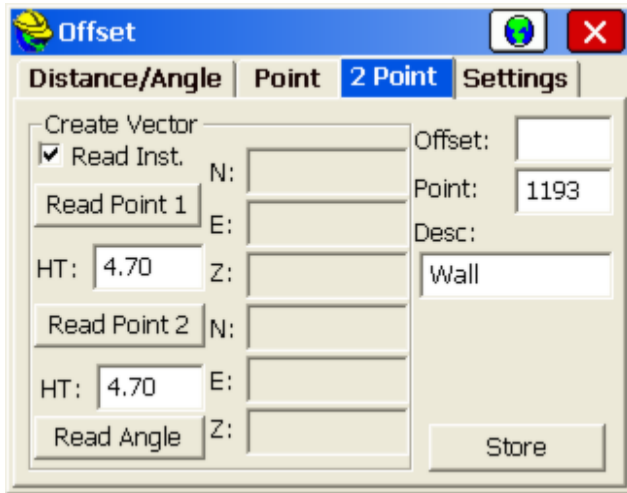

- **2-Point Offset:** This creates a 2-point 3D “vector”, where the offset direction, distance, and vertical offset are computed from the delta N, delta E and Delta Z of the two points that are measured or entered. If **Read Inst** is enabled, then the two points are measured in the field. If, instead, you wish to obtain the offset vector from two points, then disable **Read Inst** and enter the two point numbers. The offset entered will extend the vector from point “P2” in the direction of “P1” to “P2”. The vector offset will also impact the elevation that is calculated. This might be used to calculate a point at the top of a cliff, for example, where you stand above the cliff top, pick up two points on the slope to the cliff edge, and estimate the distance to the cliff face from the second point. The offset by two points routine will write an SS record in the RW5 file (raw file), which enables re-processing.
- **Settings:** The Settings tab appears with robotic total stations running remotely (from the prsim) and permits reading the target height from a laser and accesses the entire range of laser devices found in the **Peripherals** menu option under **Equip**.

Store Points (GPS)

Store Points is the principal data collection routine for GPS equipment. Store Points interacts with numerous settings, including the feature codes, and will draw line work. The Store Points screen in GPS shows the cursor moving on the screen in real-time. Measurements can be taken anytime by pressing **Enter**. The screen will pan automatically, so you are always in view as you move. Points will plot on the screen as shots are taken. See File, Feature Code List, for discussion of drawing linework, symbols, Line Details and Point Details (option to re-measure existing points).

In GPS mode, **Enter** has only one function: Read & Store. The after-shot antenna height and description prompt can be enabled in **Configure** (C or ALT-C from the Store Pints screen.). If you don't have the height and description prompt turned on, then each shot is a single press of **Enter**, and you must enter antenna

height, description, or point ID changes prior to pressing **Enter** and taking the shot.

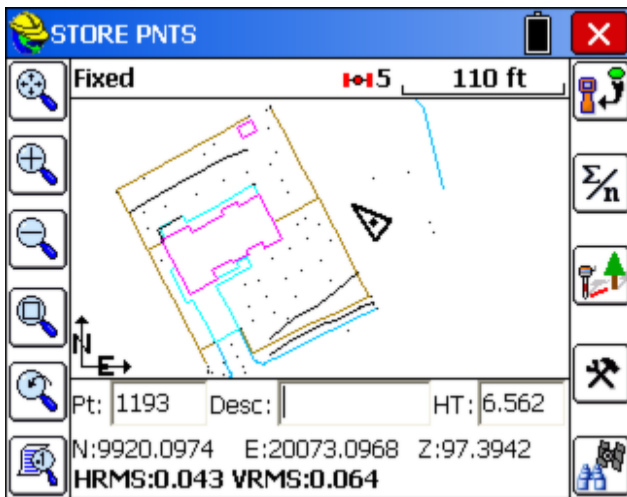

For GPS, coordinates, status (Fixed, Float, Autonomous) and HRMS and VRMS accuracy estimates are displayed at all times. The icons at the left are for zooming and panning. From top to bottom, they are: zoom extents, zoom in, zoom out, zoom window, zoom previous and point display control. If you prefer to work in a pure text screen, without graphics, you can tap the helmet icon and select **TEXT**. The following dialog will appear.

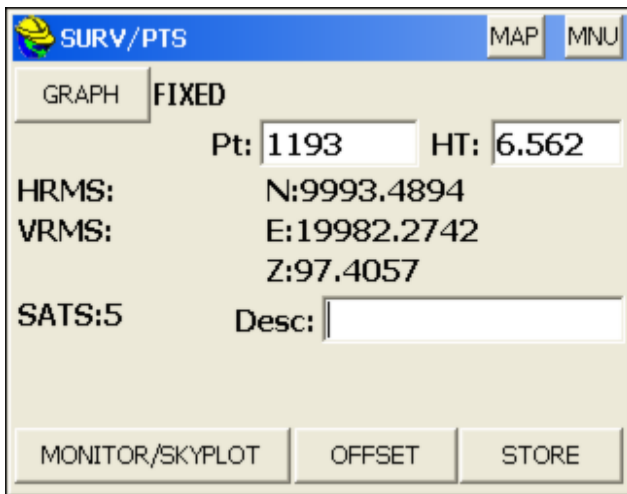

The Text screen uses a large character size for easy viewing, and limits options to Monitor/Skyplot, Offset and Store. You can return to the graph view by tapping the **GRAPH** button. You can also temporarily view your points on the screen by tapping **Map**, then tap **Back** to return to the text-based data collection screen.

Note that the program will remember which screen you were in last (Graph or Text) and return to that mode of data collection automatically.



In addition to pressing **Enter**, Points can be Stored by selecting this icon (ALT-S).

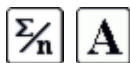

Average

With GPS, since shots tend to cluster around the true point location, it may add to accuracy to **Average** 10 or more GPS readings when taking measurements. You will be prompted for how many readings to take (up to 999). Taking 100 readings is also a way to gauge how fast your GPS equipment takes measurements. If 100 readings are taken in 20 seconds, you are reading at 5 per second, or 5 hertz (hz). After the readings are taken, a display appears showing the range and standard deviation of the readings.

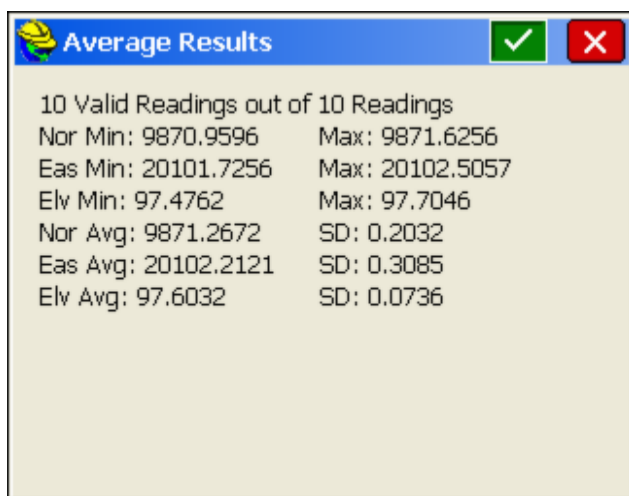

Offsets

This icon leads to **Offset** reading screens with options for keyed-in offsets as well as offsets taken by laser devices. These devices can measure distance only or distance and azimuth (ALT-O). See *Store Points (GPS Offsets)* for more details.



Configure

This icon will take you to the **Configure** dialog, also found on the EQUIP tab. From this dialog you can set the number of readings to average, specify to only store fixed readings, and turn on or off the Hgt/Desc prompt on Save (ALT-C).



Monitor/SkyPlot

This icon will take you to the **Monitor/SkyPlot** screen for GPS status, coordinates and Lat/Long display (ALT-D).

Height/Description Prompt and Camera Feature

Within Configure, you can turn on the Height/Description Prompt which provides an extra screen after the point measurement to verify all data such as antenna height and description, with the full list of selected feature codes available to choose from, as well as icons for special codes such as Start Curve, End Curve, Close, etc. If the data collector has a camera feature, the camera option is also specifically available in the Height/Description Prompt screen. So to utilize the camera option, there are two prerequisites: (1) The data collector itself must have a built-in camera feature accessible by SurvCE, and (2) Prompt for Height & Description must be turned on. There configuration options are shown below:

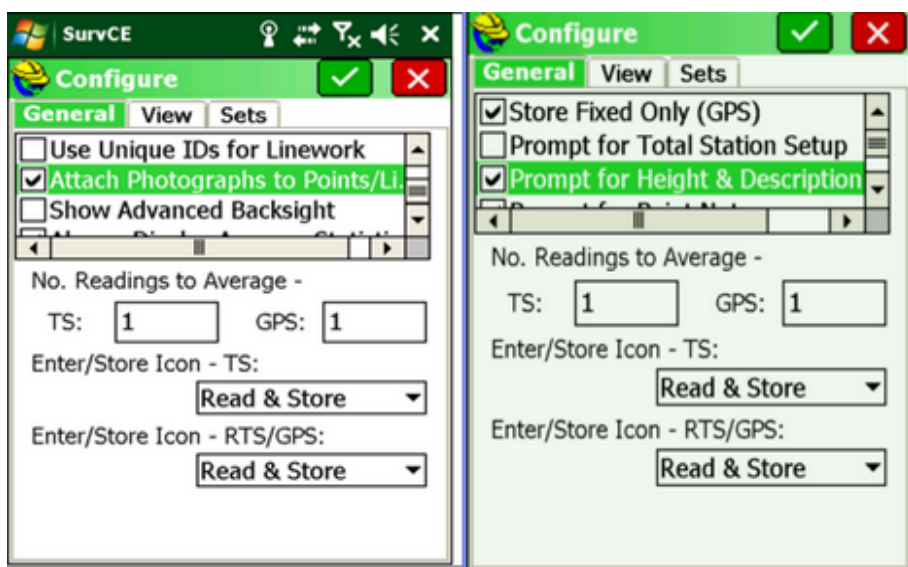

The Prompt for Height & Description is described in the section on Equip, Configuration. The use of the camera feature within Store Points (GPS) is described below. Photographs in SurvCE can be associated, as GIS data, with the measured point and description. Within Store Point, in the Height/Description Prompt screen below, a camera icon appears next to the Description edit box, if properly configured.

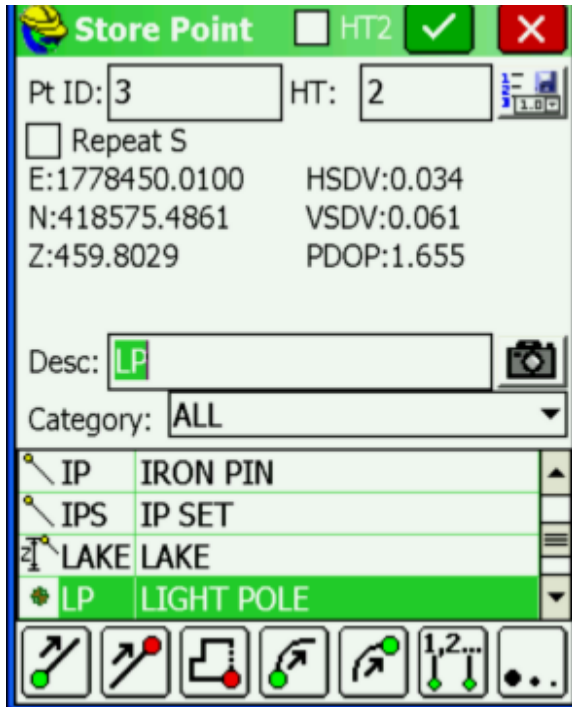

To add photographs to a point (eg. point 3) or line, click the camera button.

Photograph Gallery

In SurvCE multiple photographs can be associated with a point or line. In the Photograph Gallery a photograph can be captured or selected.

Take a Picture

To take a picture click the Capture button to launch the camera program. This will use the camera on the data collector.

Select a Picture

Browse existing photographs by clicking on the *Select* button. These photographs will be copied to the job Photograph folder and linked to the point.

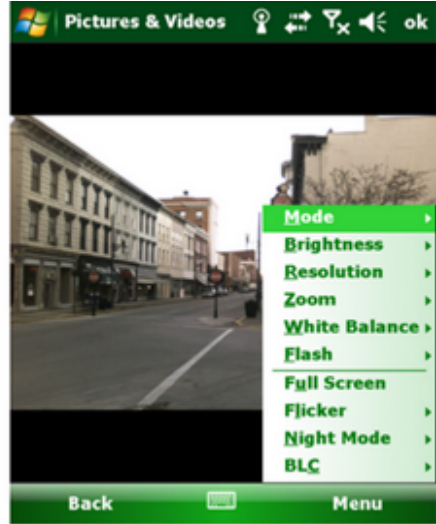

Capture Leads to Camera Program in Windows

To display your camera options and features pick the menu button. The camera options shown are for the Nautiz X7 data collector. These will vary by make and model of data collector.



To take a picture press the return button on the data collector.

To close and save the photograph click OK on the screen or press OK on the data collector.

In the case of the Nautiz X7, do not use the Camera button. This will open a Camera program not linked to SurvCE.

Store Points (GPS Offsets)

The GPS Offset command allows you to calculate and store points by specifying an offset from a GPS position. Offsets can either be entered manually or read automatically from a laser. There are three GPS offset methods: Distance/Angle, Intersection, and Two Point. The current method can be set from the Method tab.

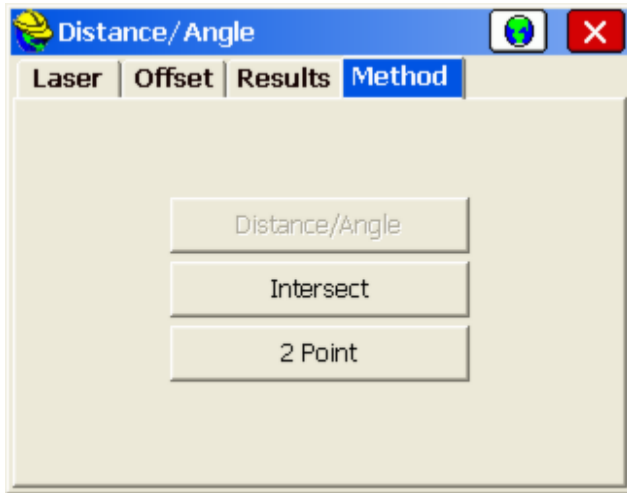

Distance/Angle Offset

In the Distance/Angle method, offsets can be specified manually by choosing the OFFSET tab, or with a laser, by choosing the LASER tab.

- Manual Offset:** Under the OFFSET tab, offsets are specified by entering azimuth, vertical, and horizontal distance offset values as show below. The azimuth can either be specified with respect to north, or with respect to a specified point. Current GPS coordinates are shown at the bottom, and can be updated via the **Read GPS** button. When all necessary data has been entered, you'll be able to store by tapping **Store**, or preview the point you're storing by selecting **Map**, or **Results**.

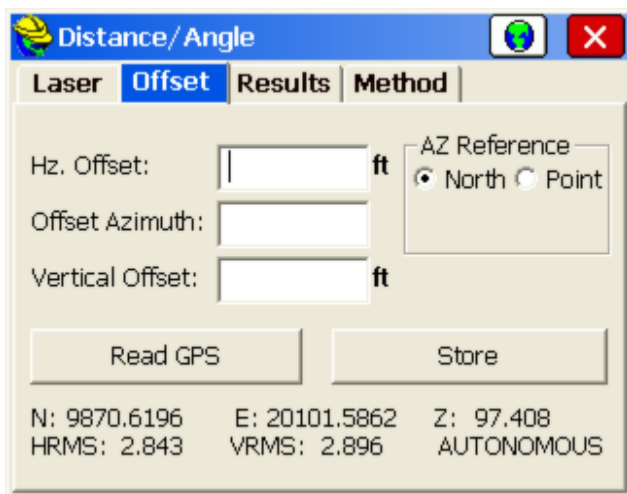

- Laser Offset:** For more accurate offsets, lasers can be used for either the distance (with direction and vertical offset entered by the user) or for both

distance and direction (where the laser gun includes compass directions). The Leica Disto, for example, provides distance only. The Laser Atlanta provides both distance and direction. Laser measurements are popular on construction sites and mine sites where it is dangerous to stand beneath highwalls and unstable rock conditions. Readings are taken from a safe location to the rock or dirt face. They are also useful for utility pole surveying and other forms of “windshield” surveys. The laser devices are often mounted on the pole beneath the GPS antenna. Special poles are available that offset around the lasers, allowing them to mount vertically, in-line with the center of the pole. If the antenna height is 2.5 meters, and the laser is mounted 0.7 meters below the antenna and 1.8 meters above the ground, you would enter 1.8 as the laser height. Laser types and laser height are set by clicking **Settings** in the LASER tab within **Offset**. This takes you to the same screen as can be found from the main menu on the EQUIP tab, under **Peripherals**. Under the LASER tab, offsets are read automatically from the laser attached to the serial port. Upon triggering the laser, you will see the reading displayed in terms of five parameters: Horizontal Offset, Vertical Offset, Slope Offset, Azimuth, and Zenith Angle, as shown below. The azimuth can either be specified with respect to north, or with respect to a specified point. Current GPS coordinates are shown at the bottom, and can be updated with the **Read GPS** button, or you can choose to have the GPS position read automatically before each point store by choosing **Settings** and enabling **Auto GPS Update**. When all necessary data has been entered, you'll be able to store by clicking **Store**, or preview the point you're storing by clicking **Map** or **Results**. Before you can begin using the Laser offset feature, you must configure the laser, either by clicking **Settings**, or by selecting **Peripherals** from SurvCE's main menu. Under the peripherals menu, you will have to activate your laser, select your laser type, and choose a COM port. It is also recommended that you deactivate all other peripherals except GPS while using the laser. For more details on laser setup, see the *Peripherals* section of this manual. Once you have activated a laser, you may click **Read Laser** to begin collecting data from the laser. In order to expedite the data collection process, the methodology for reading an offset from the laser has been optimized so that you do not need to touch your data collector between shots. This option can be enabled by selecting **Multiread Laser**. If you are a first-time user, it is recommended that you disable this option. If Multiread Laser is disabled, pressing **Read Laser** will pop up a dialog asking you to trigger the laser, as shown below. From here, you can either cancel, or fire the laser to record the shot. If Multiread Laser is enabled, when you press **Read Laser**, a dialog will appear asking you to trigger the laser, as shown below. Each time you trigger the laser, a new shot will be collected, and if there was a previous shot, it will be automatically stored. Between shots, the laser reading and the offset-adjusted position to be stored are displayed. If **Auto GPS Update** is enabled during peripheral setup, a new GPS position will be read for each shot. If a bad reading is taken, you can prevent it from being stored by pressing **Reject Last Shot**. When finished, click **Exit Shot Sequence**.

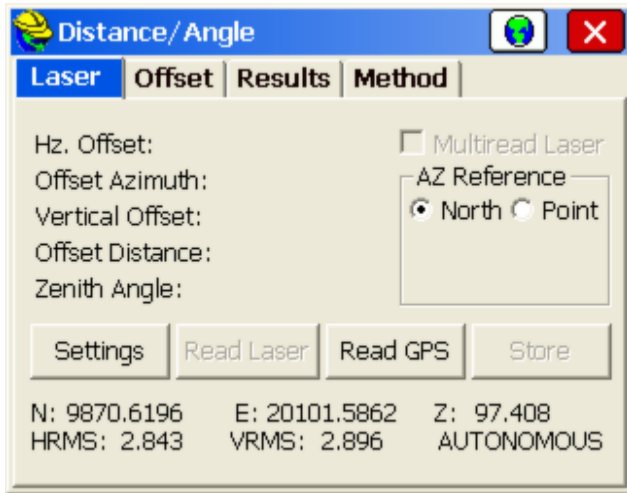

- **Results:** Before storing, you can preview the data by selecting the RESULTS tab. If valid data has been entered in the LASER or OFFSET tab, the result will appear as shown below. In this window, you can also change the GPS antenna height, or specify a vertical difference for your target point. You can also specify the point ID and description for the point that will be stored.

Offset by Intersection

Use Offset by Intersection to calculate a point based on two GPS positions and two distance offsets. The distance values can either be manually entered or input with a laser. To use a laser, you must first activate it by selecting **Settings**. For more information on laser setup, see the *Peripherals* section of this manual.

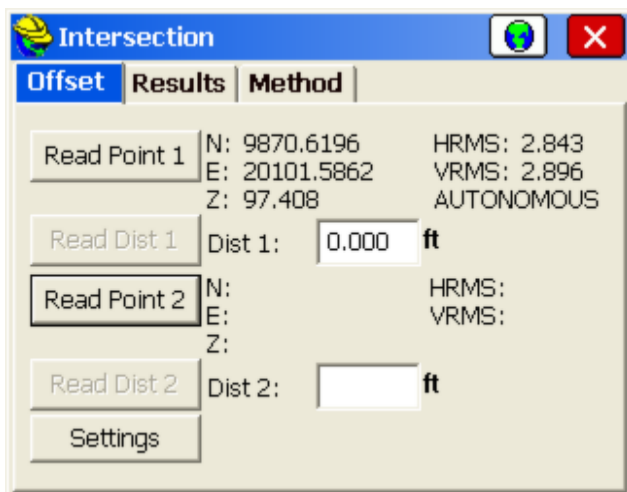

- **Offset:** Under the OFFSET tab, press **Read Point 1** to read the first point from GPS. Now enter the distance of the point to be stored, or press **Read**

Dist 1 to read this distance from a laser. Repeat this process for the second point. Switch to the RESULTS tab to see your solution. If your distances and GPS can't be triangulated, you may have to return to this tab to adjust the values.

- **Results:** After you have two GPS positions and two distances that form a valid triangle, click on the RESULTS tab to view the resulting point. If valid data has been entered in the OFFSET tab, the result will appear as shown below. In this window, you can adjust the GPS antenna height, or specify a vertical difference for your target point. You can also specify the point ID and description for the point that will be stored. The intersection method generates two solutions, so you will have to select which one you want by clicking the appropriate radio button.

Offset by Two Point

Use Offset by Two Point to calculate a point based on two GPS positions and a distance from the second point. If **Straight** is selected, the distance offset from the second point is along the 3-D vector created by the two GPS points. If **Left** or **Right** is selected, the offset is perpendicular to the 2-D vector created by the two GPS points, and the second point's elevation is used as the elevation of the resulting point. The distance offset can either be manually entered or input with a laser. To use a laser, you must first activate it by selecting **Settings**. For more information on laser setup, see the *Peripherals* section of this manual.

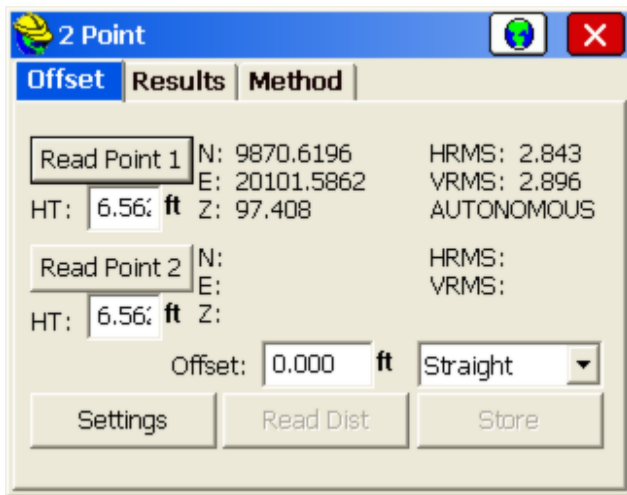

- **Offset:** Under the Offset tab, press **Read Point 1** to read the first point from GPS. Repeat this process for the second point. The GPS antenna height used for each GPS read can be adjusted individually by editing the HT fields. Now enter the offset of the point you would like to store, or press **Read Dist** to read it from a laser. Finally, specify the direction of your offset, and switch to the RESULTS tab to see your solution.
- **Results:** After you have two GPS positions and an offset, click on the RESULTS tab to view the resulting point. If valid data has been entered in the OFFSET tab, the result will appear as shown below. In this window, you

can specify a vertical difference for your target point. You can also specify the point ID and description for the point that will be stored.

Stake Points

This command allows you to stakeout a selected point by guiding you to the point with a series of commands and directions. The point can be a Point ID or the endpoint, mid-point, intersect or other "snapped" point on a map (using the **Map** icon). Various options can be set in **EQUIP, Configure, View Point** to adjust how the directions are provided to best suit your needs. The Tools icon or C to Configure also will access the View Point settings. You should also review the **Job Settings** under **FILE** before staking. The dialogs are varied slightly with respect to total station or GPS equipment. Both types are documented here, illustrating the differences between the dialogs.

The image shows a software dialog box titled "Stake Points". The title bar is blue with a yellow icon on the left and a green checkmark and a red 'X' button on the right. The main area is light beige. It contains the following elements:

- Point ID:** A text box containing "58" and a list icon to its right.
- Source:** A dropdown menu showing "Current Job".
- Point by Direction:** A checkbox that is currently unchecked.
- Buttons:** "Add To List" and "Pick From List".
- Northing:** A text box containing "9954.8820".
- Easting:** A text box containing "20098.6350".
- Elevation:** A text box containing "101.0810".
- Description:** A text box containing "CP/CHIS X".
- Azimuth:** An empty text box.
- Slope:** An empty text box.
- H. Distance:** An empty text box.

Note: While in graphics mode stakeout, if you press the down arrow key, you can increase the plan view size and eliminate some of the text information. Pressing the up arrow key again reveals the cut and fill.

After selecting **OK**, the main stakeout window appears in **MAP** view. In manual total station mode, the angle to turn to and the distance to the stake point will be displayed at the bottom of the screen. Shown below are the graphic icons, set under **EQUIP, Configure**, using a motorized or robotic total station running direct from the instrument in prism mode (not reflectorless).

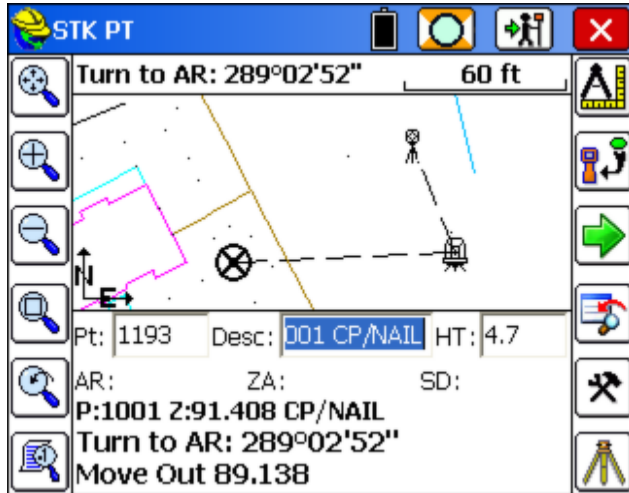

A read function is required to update the directional display information. You should see your points in the map with an icon showing your target location (the circle with the X inside).

Measurements are taken typically by pressing **Enter**. **Enter** also transitions automatically from the Stake Points entry screen to the Stk Pt measurement screens above. Point Stakeout can be conducted without touching the screen, using the **Enter** key and entering point IDs using the keyboard. Both screens are explained below, starting with the graphic Stk Pt screen.

- Total Station or Robotic Total Station running Direct** After reading and taking the shot, the display will be updated with a distance and direction to the stakeout point. Buttons on the right from top to bottom are Read, Store, Next, Menu, Configure and Setup. **Enter** is treated as **R** for **Read**. Pressing **S** (or "Store to Collector" icon, 2nd from top right) will go to the **Stakeout Report** screen and allow you to write to the "cutsheet" file the cuts and fills and optionally to store the measurement as a new point ID.



- **GPS or Robotic Total Station with Tracking On:** Your current position is read immediately (no Read button needed). **R** takes a fresh reading. If you press **R** for **Read** or **S** for **Store**, you will go to the **Stakeout Report** Screen. **Enter** is treated as **R** for **Read** and takes a fresh reading, then proceeds to the **Stakeout Report** screen. If you are outside of accuracy tolerance, you will be warned and asked if you wish to proceed. In the **Stakeout Report** screen, you can save your cut and fill data to a cutsheet file and optionally store a new point ID based on the fresh measurement taken. If you click off tracking, then the angle to turn for staking is displayed, same as with regular total stations running direct. With robotic total stations, if you are locked on and tracking, you will see instantaneous instructions on directions to move to the point, meaning that you do not need to take a reading to locate the point. Just move to the point based on the instructions. If the screen is not updating, it is recommended to turn off lock and then re-acquire lock by tapping the lock icon twice, verifying that tracking also is on. Then the instructions to move will stream in real-time.
- **Robotic and Motorized Total Stations, "Turn to Point":** In Total Station, Search Tab (Equip menu, or accessible through the tripod icon or C for Configure), you can turn on "Turn to Horizontal" in Stakeout. If this is turned on, the instrument will turn to the target point automatically. If "Turn to Vertical" is also on, and the correct target height is entered, the instrument will turn to both the horizontal and vertical position of the target. Do not use "Turn to Vertical" if the elevation of the target point is 0 or not accurate.
- **Point ID:** This is the point which you are staking. You can enter it in here and hit the **Enter** key to view the elevation, northing and easting before selecting **OK**. If you want to stake out a range of points, you can enter in the points in the following format: 3-10,2,15-20. This would stake out the points from 3-10 sequentially, then point 2, then 15 through 20 sequentially. N for Next would move to the next point in the list. If you are using a control file in total station mode, and you enter a point number which also is present in the current job file, it will choose the control file point if **Control File Has**

Priority is enabled in the stakeout section of **Job Settings**. If you enter a point number that is not in the control file, but is in the current job's coordinate file, then that point will be used. You can also select the points to stakeout from a list by selecting the **List** icon. If you select the List option, you can select the points for stakeout from the active job file or the control file. To do this, you must toggle between the files using the **Job** and **Control** toggles at the top of the dialog. You can select a range of points by selecting the first point to stake then pressing the shift key and selecting the last point to stake. All points between the two selected points will be staked in sequential order. You can also add to the selection of points to be staked by pressing and holding the **CTRL** button and individually selecting the points to be staked. The final way to select an individual point to be staked is by selecting the **Map** icon and tapping on the point to be staked. Using the **Map** icon, you can also select points to stake from linework on the screen, using the endpoint, intersect and other "snaps".

- **Add to List, Pick from List:** When you select or enter multiple points, they appear in the Point ID dialog window. You can then pick **Add to List** and create a list of these points in the order they were selected. When you Add to List, the Point ID dialog is cleared, and you can select more points, place them in the dialog and click Add to List again. Then you can stake any of them using **Pick from List**, where the points appear as shown below:

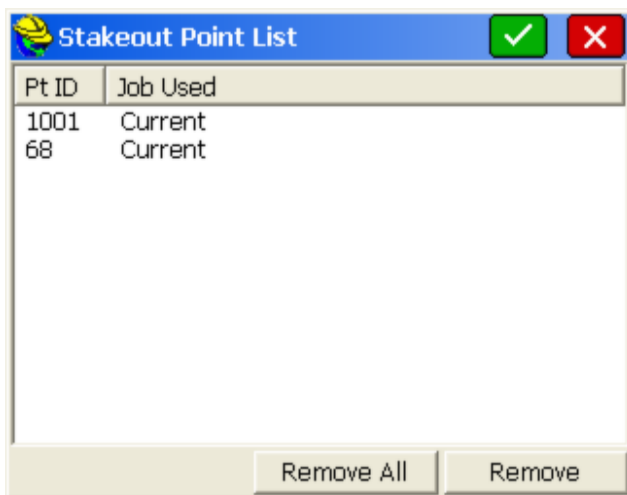

- **Source:** When you press **Enter** after selecting the point (or points), the program will display the source of the points, either as Current Job or Control File. The display of the source is important for verification. You may discover, for example, that someone has turned on **Control File Points have Priority** in the stakeout settings, and this is a way to catch the mistake.
- **Nothing, Easting, Elevation:** You must have a northing, easting and elevation entered for the point you are staking out. If you type in the point number of an existing point and hit **OK**, these values will appear automatically. The description of existing points is displayed at the bottom of the dialog.

- Point by Direction:** In addition to staking a point ID or entered coordinate, you can stake a point defined by a direction and distance, and even slope, from the entered point coordinate. This allows you to stake points without calculating point numbers or point IDs for the target point. Simply enter the bearing/azimuth, horizontal distance and also slope, if applicable. If the distance entry is not known but must be computed, the calculator is accessible from the distance dialog box by hitting the ? button. Shown below is a stakeout of a point calculated at NE45 degrees, 100 feet, from point 10.

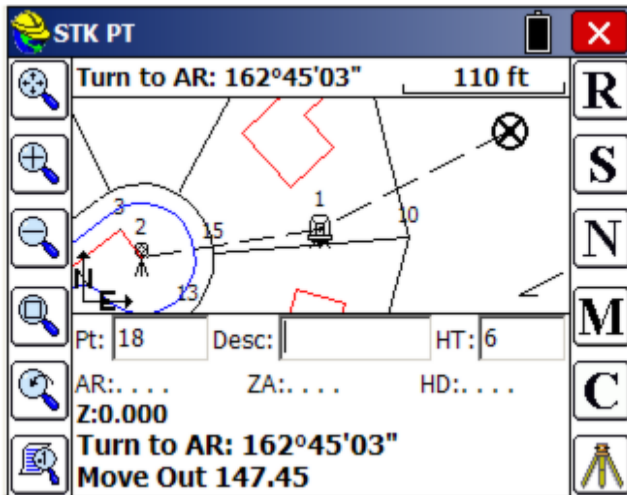

N for Next (Increment Up or Down)

On some projects, you may find that it is more convenient to stakeout points in descending order.

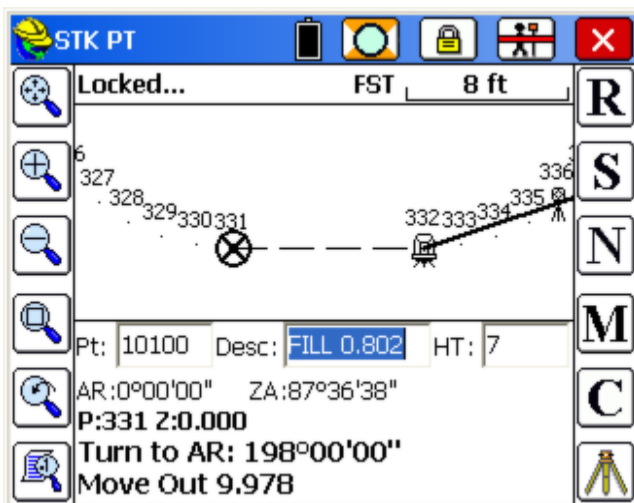

This can be accomplished by going to **File, Job Settings, Stake** tab, and switching to increment in descending order. If **Increment ID Down** is set, then N for Next would go to point ID 330, then to 329, etc.

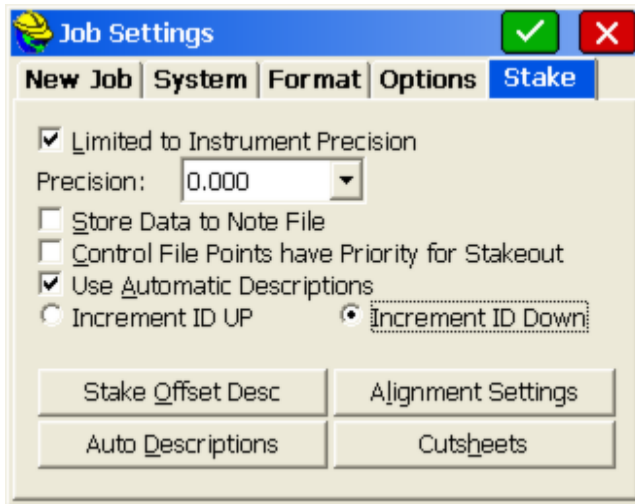

View Pt

Depending on your settings in the **View Pt** tab of **Configure** (in the **EQUIP** tab), the direction to stake will either be Right/Left Distance, Azimuth and Distance, or North/South East/West Distances. The cut or fill is the elevation difference between the point read and the point being staked. Normally, you take a shot simply by pressing **Enter**. After a total station shot is taken, you will see your “In-Out” distance to the target point. For total station stakeout, the direction of the reference is shown by a little arrow in the lower right of the screen.

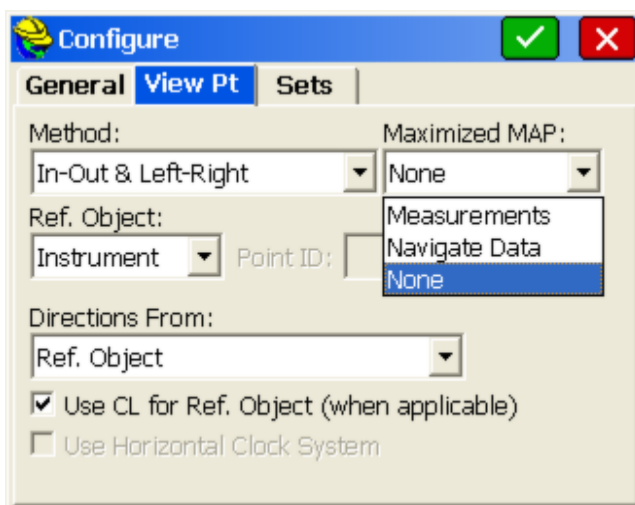

Stakeout Report Dialog

Selecting **S** to Store will display the Stakeout Report. You can turn off the **Store Point** option, and just reference the Stakeout Report screen for information. If the tolerance distance is exceeded for staking out, you will be notified and asked if you want to continue storing. (Stakeout Tolerances are set under Tolerances in the **EQUIP** menu).

	Northing	Easting	Elevation
Staked:	9919.747	20112.541	102.023
Design:	9920.182	20113.865	106.704
Move:	North:0.435 ft	East:1.324 ft	Fill 4.681
VOff 1:	<input type="text"/>	Elv: <input type="text"/>	
VOff 2:	<input type="text"/>	Elv: <input type="text"/>	
ZA:	91°50'28"	AR:359°59'58"	SD:7.6850
<input checked="" type="checkbox"/> Store Point	Point ID:	1193	
Point Description:	STK1192 FILL 4.681		

The coordinates for the Stake Point and the Target Point are displayed. The delta North, East and the elevation difference (Cut/Fill) are also displayed. The vertical offset input boxes allow for elevation calculations based on the input vertical offset values. The vertical offsets can be entered in inches in English units in two forms (10" using the inch designator, or 0.10.3.8 for 0 feet 10 and 3/8ths inches). The second form requires 3 decimals to be used.

If **Store Carlson Cutsheet Data** in Note File has been enabled, the vertical offset(s) specified will be recorded in the .not file for the job. If under **Set Cutsheet Format** in the Stakeout section of Job Settings, a Set Pt Cutsheet Format has been established with a named file for storage, then cut and fill data will be saved to a cutsheet ASCII file. If using GPS, the HRMS, VRMS, and PDOP values are also displayed. Fields for Point number and point description input are also displayed. If, for example, you choose not to store a staked point, but only report the design point, design elevation, surveyed elevation and the cut and fill, you could produce a simple cutsheet report as shown below. One vertical offset per shot was recorded (-10"). The cutsheet can be reviewed from within the active stakeout screen using Alt V. You can also click on the helmet and go to View Data to see the cutsheet report, while actively staking out, and you will be returned to the stakeout screen. Cutsheet data is always stored to the raw file, so if you forgot to store the cutsheet information, you could create a new point cutsheet file and select "Cutsheets from Raw File".

DesignPt	DesignEL	StakeEL	Cut
2	843.31	846.39	3.08
2 -0.83	842.48	846.39	3.91
13	842.47	846.39	3.92
13 -0.83	841.64	846.39	4.75
15	842.43	846.39	3.96
15 -0.83	841.60	846.39	4.79

Pressing **OK** (which optionally will Store Point if enabled) will return to the Stakeout Points dialog to select the next point for staking. If the Use Control File option is set under the Job Settings, you have the option of staking control file points. If you enter in a point number to store that is the same as a point number in the control file, the point in the control file will remain unchanged. It will only modify the point in the current coordinate file. If the point being stored is the same as one in the current job file, the **Point Protect** dialog box appears stating that the point you chose is already used. The next available point number is listed with the option to overwrite the current point, or use the new number.

Review of Stake Points Graphic Screen (Robotic Total Stations)

The Stake Points screens below illustrates many options available to the user when using a robotic total station.

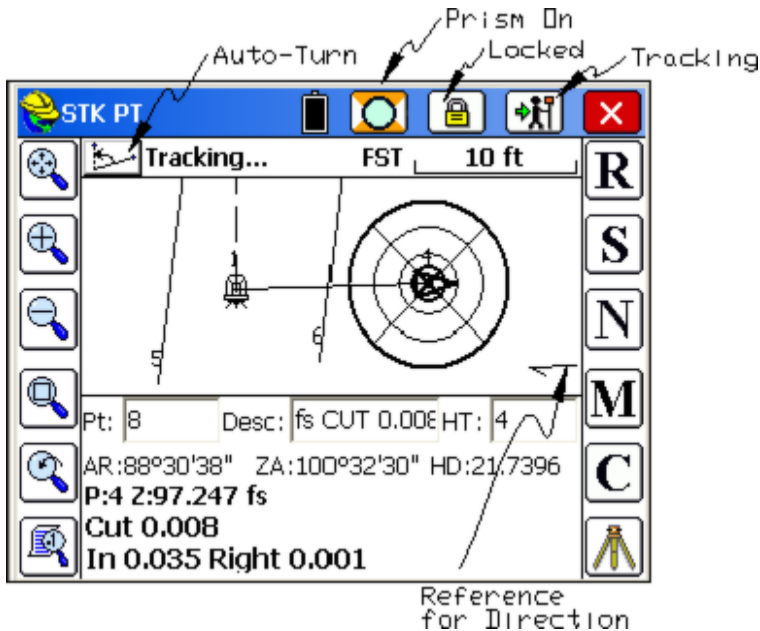

- Auto Turn:** This option only appears if you are configured for a robotic total station with Turn to Horizontal set on in Search. Search can be accessed using the Tripod Icon (lower right) and selecting the Robotic tab, leading to Search or by clicking Total Station within Configuration and selecting the Search tab. Even C for Configure gives access to Search. Clicking Auto-Turn will turn the instrument to sight on the target point. If Turn to Vertical is also on, the instrument will sight the vertical position correctly, based on the target height. Do not use Turn to Vertical if the elevation of the target point is inaccurate or zero. Note that with Turn to Horizontal on, the instrument will do the turn automatically in stakeout. You only need to click Auto Turn if you want to force a new turn to the target if the instrument has been moved off the target.
- Prism On vs Reflectorless:** For total stations with reflectorless capability, a prism icon is displayed at the top of the screen which allows you to select prism on (as shown) or click to prism off/reflectorless, which then displays a line through the prism.
- Locked vs Search:** For robotic total stations, the lock and search (binoculars) icon is used to display the status of the instrument. When the lock is shown, the instrument is locked onto the target. If you press the lock icon, it will switch to Search mode. For Tracking to occur (distance measurements leading to known target position shown by triangle), the instrument must be locked. If the binoculars are shown, the instrument is in Search mode, and pressing the Search icon (binoculars) will start the search process, with the window of the search determined in Settings. When the prism is found after a search, it returns to lock mode.
- Tracking:** Tracking is available with robotic total stations, and indicates that distance measurements are being taken to the target. Tracking on leads to

known position of the target, which then appears as a triangle. Tracking will use more battery life on the instrument. If turned off, the tracking off icon appears as a rodman with a line through it. With tracking off but lock on, the direction of the instrument typically appears as a line or beam radiating from the instrument position. In all stakeout routines, with tracking on and active, instantaneous, real-time instructions to move to the point are provided.

- **Reference Line for Direction:** The Left and Right instructions for direction to move are provided in reference to either a point or the instrument as set in View Point. This reference direction is shown in the lower right of the screen.

Staking by Graphic "Pick Point" Selection

One of the interesting features of SurvCE point stakeout is the ability to stake to a points on line elements without the creation of point numbers. You can just stake

to the graphics using the "from Map" selection icon:  In this way, any drawing is a fertile field of available stakeout points, and complicated intersections involving spiral curves and other elements can be staked simply by using commands like Offset followed by snapping to intersections. Consider the example below:

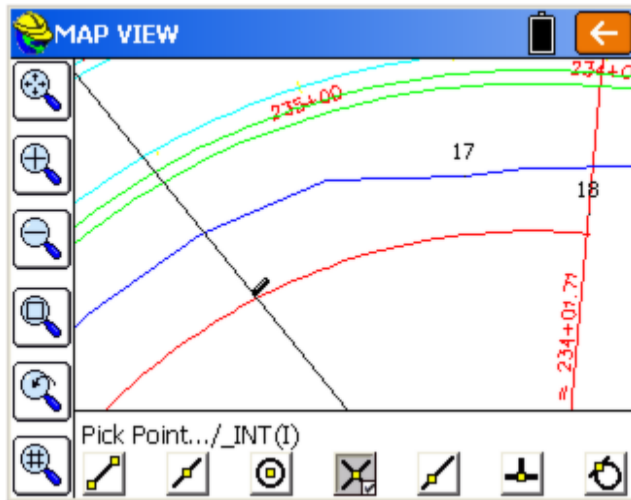

The road section from 234+00 to 236+00 is in a spiral curve and the goal is to intersect the right-of-way of the road, which is at a 50' offset from the centerline, with an original property line running NW to SE. Rather than use complicated coordinate geometry, the Map screen can be used to select Draw, Offset and create a 50' offset line of the road, shown above. Then within Stake Points, where point 17 is the occupied point and 18 is the backsight point, the point to stake can

be selected using the  Map icon, and then the intersect snap (highlighted in gray above) can be used to find the intersect of the spiral curve to the property

line. Note that the snap to the right of the intersect is the "nearest" snap--it picks up any point you pick on the linework, not necessarily at an endpoint or intersect point. Upon clicking the orange return arrow at the top right, the target point is computed. No target Point ID is created or is necessary. You can simply "stake to the drawing".

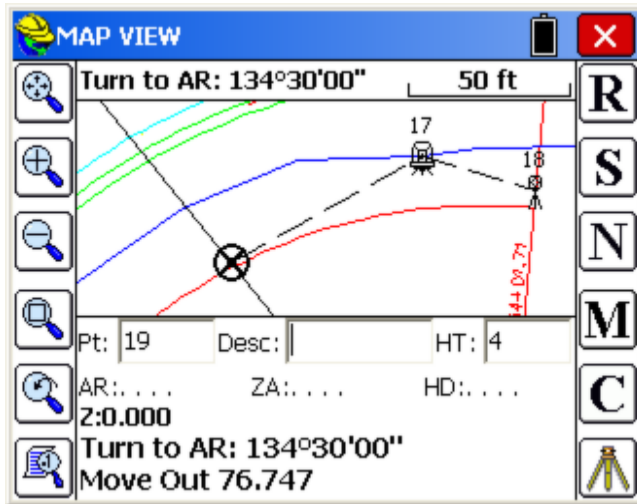

Using the graphic screen selection of points, you also have the ability to see the last point picked. So if you are selecting a series of tightly-spaced "endpoints" of lines, using the endpoint snap, you can see your last point, and pick the next one, by reference.

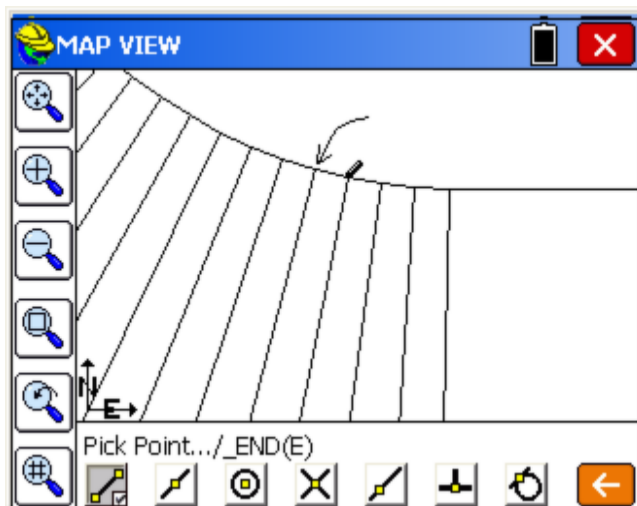

The last point selected is shown by a pencil, so if you are staking endpoints right-to-left, you select the next point shown illustrated here by an arrow. The previous "snap" used, such as "endpoint snap" highlighted above, is the default,

allowing you to pick the next point immediately. If you don't pick a new point but instead click on the orange arrow, the program will default to the highlighted point (indicated by the pencil), and you will be re-staking the last point selected. So this option allows you to re-stake the last point and also reference the last point when staking another.

Note: The graphics screen will show text such as stationing (eg. 235+00) or lot numbers if the text is first converted to polylines before being imported as a DXF or DWG file. Carlson Survey, for example, has a command called "Text to Polylines" that can be used to convert standard text into polylines for presentation within SurvCE and other programs.

Using the Helmet Options

While in Stakeout, and without leaving the command, the Helmet can be used to access various reports and even conduct basic editing. When the Helmet (in the upper left) is clicked, the dropdown menu of "quick access" options appears:

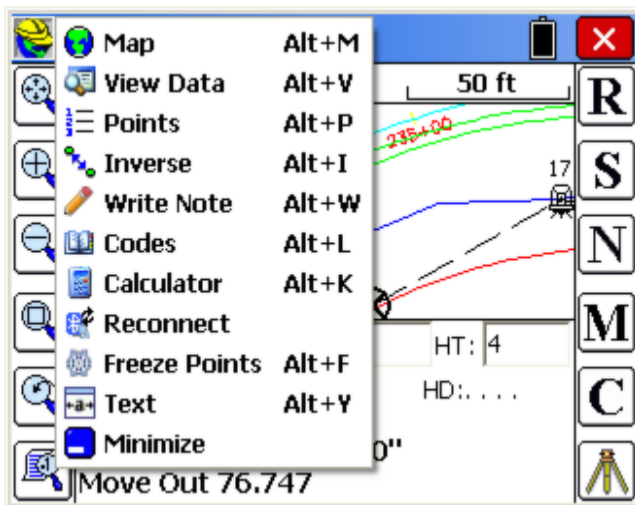

Some of the more useful commands to access, at any time, are Inverse (obtain 2D and 3D distance between points), View Data (review the cut and fill "cutsheets" and review and edit the raw file), Points (review the coordinates in the job file, delete and edit as desired) and Freeze Points (to freeze the point numbers and reduce clutter on the screen). The Calculator can be accessed to compute angles between points (triangle solution, pick 3 points), to compute math expressions and to convert between Lat/Long and grid coordinates, among other things. The "Reconnect" option is a quick way to reestablish the Bluetooth connection to the instrument.

Graphics Screen Expansion: Normal (None), Navigate Data, Measurements

One of the special options available in Stakeout is the ability to maximize the graphics screen using the down arrow to enlarge the graphics (reduce the lines of

text instructions) and the up arrow to return to normal graphics. Since the text instructions for stakeout are minimized in expanded graphic mode, you can control what content is provided in the one-line instruction by the setting in Viewpoint (Viewpoint tab within C for Configure, see discussion above). When the "Maximized Map" is set to **None**, then for total stations in direct mode, the instructions are the angle right to turn (top of screen) and the one-line display shows only the new point number and target/rod height. The screen at right is referred to as the "Maximized Map".

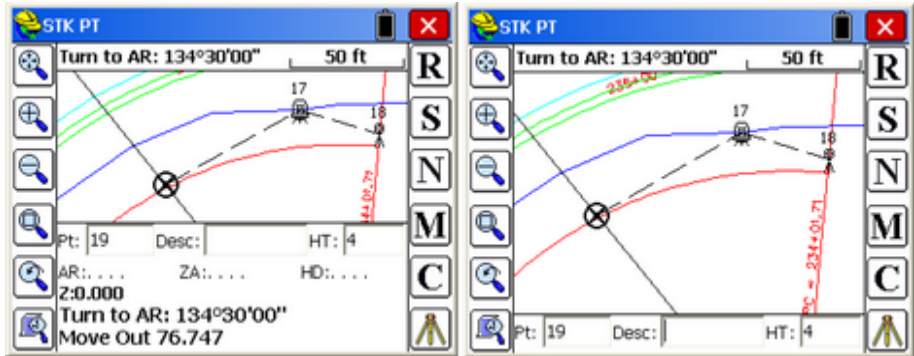

For robotic total stations in tracking mode and for GPS, the "None" setting in ViewPt, Maximized Map shows only the target and the lower line at right. In this case, the "Navigate Data" setting is beneficial. This adds an extra instruction line. Shown below is Stakeout with **Navigate Data** set for Maximized Map within ViewPt, running a robotic total station in tracking mode.

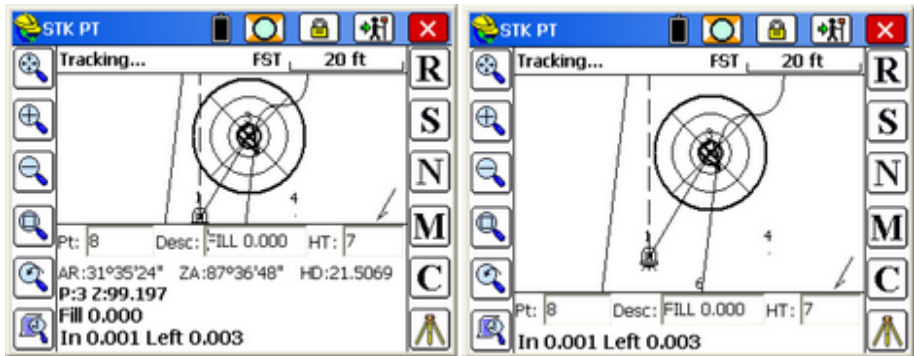

There is a third mode for the Maximized Map which is called "**Measurements**". With this mode set, and running a robotic total station, the larger map appears as shown below, with the current measurement data presented on a second line.

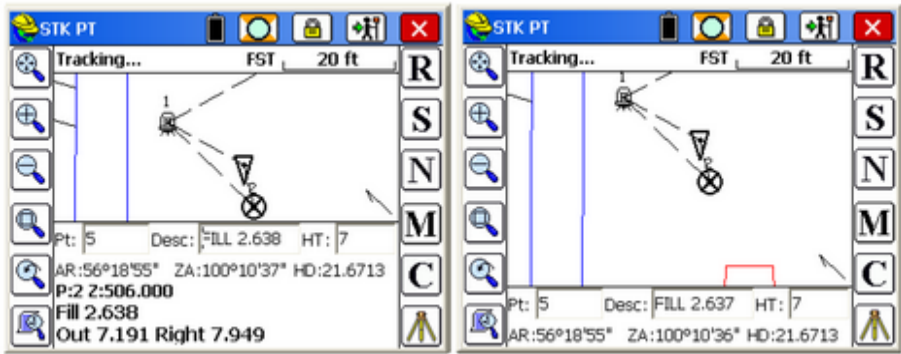

The expansion of the graphic screen in stakeout can be accomplished two ways: (1) press the down arrow to expand, up arrow to return to normal (at left) and (2) place your finger or stylus in the first line, near the "Desc" and pull down and repeat the process and pull up the screen. (For restoring the full screen, the up arrow is the easiest method).

Stakeout Points using the Text Screen Mode

Some surveyors prefer a text screen for stakeout with no graphics and large, bold text characters. Using the Helmet, as described above, you can select "Text" or enter Alt Y and go to Text mode for stakeout. The program then goes to a different display mode with larger text for improved readability, as shown here:

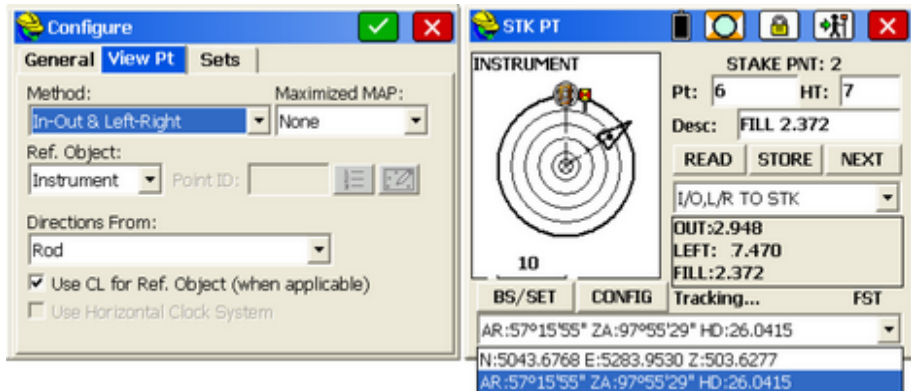

The instructions given are controlled by the settings in Configure, View Pt tab. In this case, the instructions are In-Out, Left-Right facing the instrument from the perspective of the rod or prism. This would be a typical configuration for running as a one-man crew working from the rod and facing a robotic total station. In the "bullseye" diagram, the target point is the center of the bullseye, the instrument is shown relative to the target point (which is at the top of the circle if due North) and the backsight is shown as a square target relative to the instrument. Your position is shown as a triangle, with tracking on (or with GPS). As you look at the instrument, you need to go Left to the center of the circle and back up or go Out. You can report the measurement or the actual coordinate based on the

setting at the bottom of the screen, and your instructions can be set dynamically, within the stakeout screen, without needing to return to Configuration, by using the pulldown options in the middle right of the screen (current setting is In-Out, Left-Right). Your goal in Text mode is to get to the middle of the circle.

Another feature of Text mode is that when you enter a description, the program uses the full screen to display available descriptions and automatically scrolls to the descriptions that begin with the letters or numbers that have been entered. In the example below, the entry of "31" scrolls to the descriptions beginning with 31.

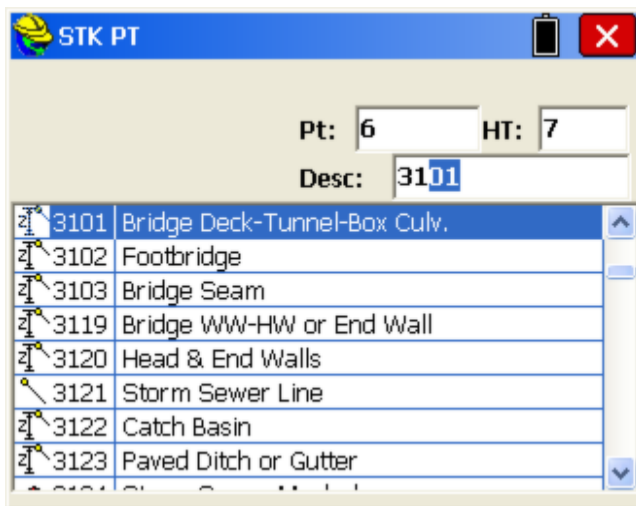

Click the one you want and then press Enter on the keyboard to return to Stakeout.

Stake Line/Arc

This command opens a secondary dialog where you can choose between Define Line (single line, no curves), Define Alignments, Define Arc (3 points), and Define Arc (PC, PT, Value). If within the Configure option, "Prompt for Total Station Setup" is clicked on for total station work, the Stake Line/Arc command will go first to the backsight screen. When taking the backsight, note that with Leica "ATR", or Sokkia "Search on Read" or Topcon "Auto Aim" clicked on, you can be sighting your backsight slightly off the prism, and the instrument will read and lock to the crosshairs. This can save time on dialing in precisely to the center of the crosshairs, both for backsights and for foresights. This can accelerate the work especially when doing repeated stakeout measurements.

Stake Station Interval: The Stake Station Interval option, when clicked on, leads to a dialog that includes the station and offset to stake and the interval to increment. It allows the staking of particular locations on an alignment. When Stake Station Interval is clicked off, the program reports the station and offset of measured points and for your current position (GPS and robotic total stations), and does not prompt for a target station, offset and interval. It leads to fewer

screens and does not include the "Point on Line" and "Point on Arc" options, which appear specifically in the Stake Station Interval dialogs.

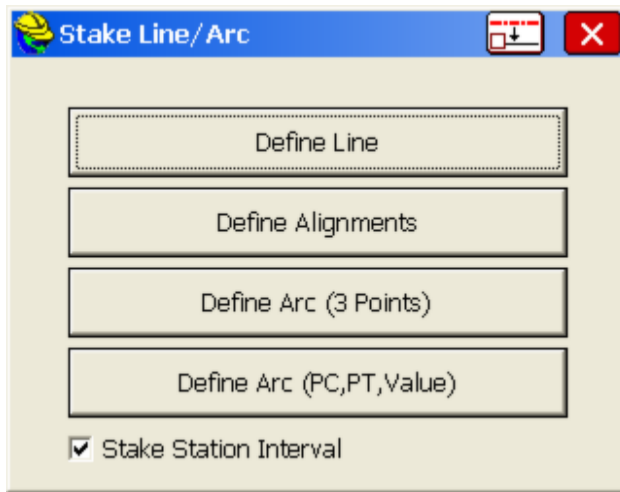

Reference Centerline:  The middle icon on the top line leads to global settings that allow a master centerline (horizontal alignment) to be designated for reference, while you stake out a separate alignment for L and R instructions. For example, if you are staking a curb or right-of-way, you could designate the main road centerline as the "master centerline" and the curb or right-of-way alignment as the target alignment for stakeout. If you "Use Reference CL for Station and Offset", then you obtain reports of the station and offset of your position relative to the master (reference) centerline. Other options include referencing only the station or only the offset of the master centerline. And if you click on "Use Reference CL to Display Directions", then your instructions to move in the field lead you to the target alignment but reference the master centerline. In the screen below, you select the name of the master centerline. You can also designate whether curves are based on "railroad" definition or standard road definition. Note that even the appearance of this option is controlled by Job Settings, Stake Tab, Alignment Settings, option "Allow Reference Centerline". If off, the Reference Centerline icon itself does not appear.

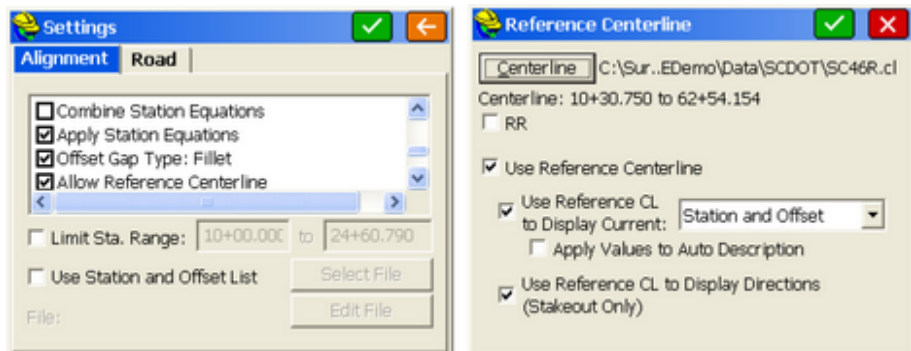

Define Line

This command allows you to stakeout to a line between two points by guiding you to the point with a series of commands and directions. It is also specifically the option to use for staking a "Point-On-Line" such as when marking a property line. A Reference Alignment can also be used (see discussion of Reference Alignment within the Define Alignments option below).

This option is for setting out points along a line including the cut or fill, or for staking out points relative to the line. One application, for example, would be staking a pipe between two known points (inlet and outlet), where offset stakes can be set with cut/fill noted. Station Store might even be used to calculate, in advance, the inlet and outlet points based on a known station, offset and elevation. For all staking, there are configuration settings that govern the type of instructions you receive in stakeout. You should review the settings in the **Stake** tab under **Job Settings**, as well as the **Configure** option within Equip before staking. The dialogs are varied slightly with respect to total station or GPS equipment. Both types are documented here, illustrating the differences between the dialogs.

Stakeout by Define Line also has a **Point On Line** tab that enables, in total station mode, staking of the intersect with the specified line on the current line-of-sight. This is often used to set stakes or flagging along a property line by sighting gaps in tree lines. The surveyor finds a gap in the line, takes a reading to the prism and is advised how far to Move In or Move Out to stake the line at the current line-of-sight. The **Point on Line** tab also includes the standard perpendicular method, where any measurement is used to compute the direction and distance to move to go to the point on the line perpendicular to the measured point. For GPS configurations, Point On Line offers only the Perpendicular method.

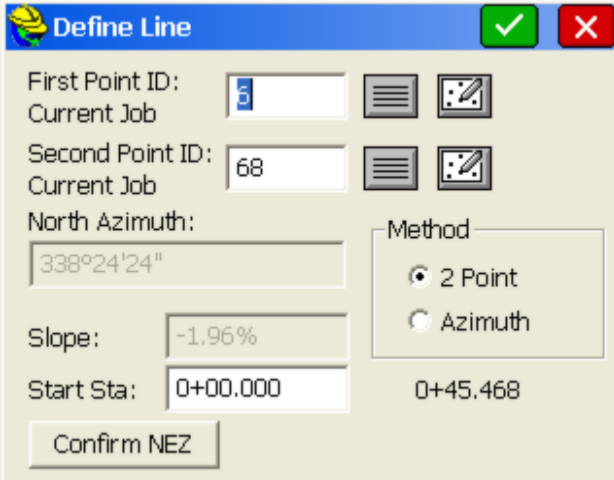

Define Line

First Point ID: 6

Current Job

Second Point ID: 68

Current Job

North Azimuth: 338°24'24"

Slope: -1.96%

Start Sta: 0+00.000

Method

2 Point

Azimuth

0+45.468

Confirm NEZ

The Define Line dialog gives you the following options:

- **First Point ID:** This is the starting point of the line. You can enter the point

here by point ID. The first button brings up the list points dialog where you can select the starting point of the line from a list. The button directly to the right allows you to choose your point from the map instead. If you pick a point from the map in a crowded area of points, you will be directed to the list points dialog to select the desired point among those near to your chosen position.

- **Second Point ID:** Pressing **Enter** from the first point moves the cursor to the second point. This is the ending point on the line that is only available for entry if **Method** is set as two Point for defining the line. The procedure for selecting this point is the same as for the first point.
- **Azimuth:** This option will be available for input only if **Method** is set to Azimuth. If Method is set to Two Point, then the Azimuth is inactive, but still displays the azimuth or bearing between the two points of the line. The Azimuth method will prompt for bearing if **Angle Type** is set to bearing in the **Format** section of **Job Settings**.
- **Slope (%):** Just like the Azimuth, this option will be available for input only if **Method** is set to Azimuth. If Method is set to Two Point, then the slope is inactive, but still displays the slope between the two points of the line.
- **Method:** This options lets you choose how to define your line. The available options are by two points, or one point and an azimuth and slope.
- **Start Station:** This option defaults to 0 within Stakeout Line, but can be changed to any starting station.
- **Confirm NEZ:** Selecting this button brings up the **Confirm NEZ** dialog box. This screen displays each point as a tab at the top of the screen. Listed is the point number, Northing, Easting, Elevation and Description of the point(s) selected for the line. After you confirm the points, selecting the back arrow will take you back to the line definition screen. Pressing **Enter** after Confirm NEZ automatically continues to the next screen.

If "Stake Station Interval" is off in the opening dialog to Stake Line/Arc, then you would go directly to the measurement screen as shown below. If using GPS or robotic total stations, your current station and offset is shown immediately, real-time.

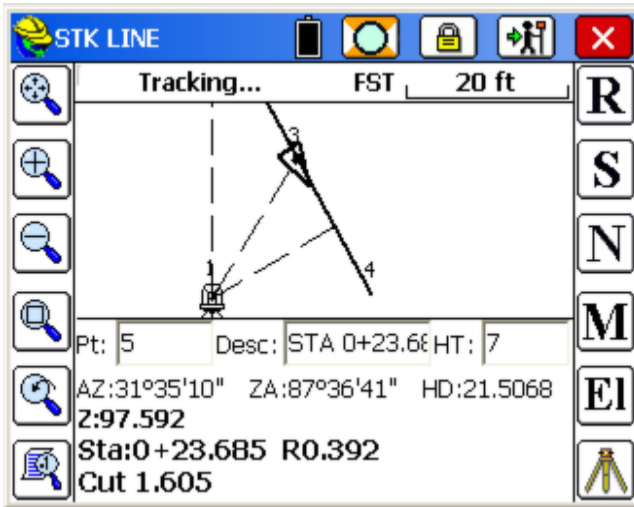

Stake Station

Interval Off

For standard total stations, a measurement must be taken (Enter key or R for Read) to see the Station, Offset and Cut or Fill. With total stations, dashed lines are drawn from the instrument to the backsight, to the current point being measured, and perpendicular to the defined line. In the graphic above which applies to robotic total stations, the icons on the top line indicate battery status (full), prisms are being used, the instrument is locked on the target prism, and tracking readings are occurring so that the position of the prism can be computed (the triangle). If you choose "Stake Station Interval" (set in opening screen) when using Stake Line, then you will be prompted for the station to stake, as shown below:

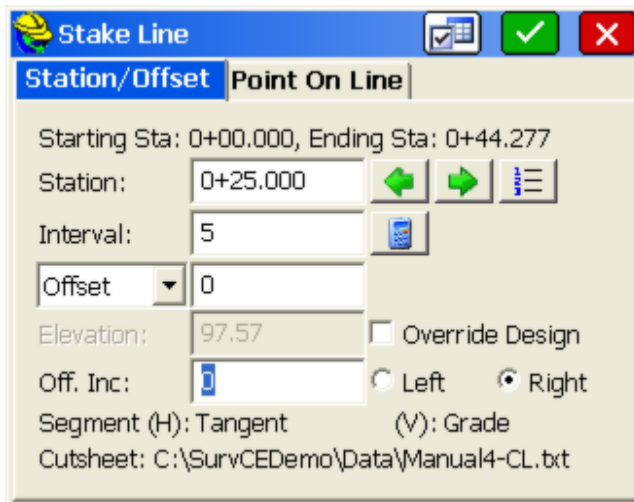

Stake Station

Interval On

Clicking OK (green checkmark) proceeds to the stakeout screen. The settings

button on the top of the screen, left of the green checkmark, will let you stakeout the precise end of the alignment (in addition to even stations), extend the alignment and do many other special features such as load a list of targeted stations and offsets to stakeout along the alignment. In the graphic stakeout screen, you will be advised to move to the target point based on the Viewpoint settings under Equipment, Configure, Viewpoint tab. It is recommended to click on "Use CL for Reference Object (when applicable)" when the horizontal alignment is clearly visible or known in the field. Otherwise, you could use the instrument as reference for total station work, moving in or left and right as you face the instrument. Here, the reference is the alignment itself, and you are advised to move In towards the alignment and Forward along the alignment.



Stake Station

Interval On

Define Alignments (Horizontal)

Stakeout Centerline only requires a horizontal alignment, but you have the option to specify a vertical alignment which will lead to cut and fill results as well. Additionally, you can specify a reference alignment. This feature allows you to stake the offset off of one alignment (e.g. curb) and report the station of a reference alignment (e.g. centerline).

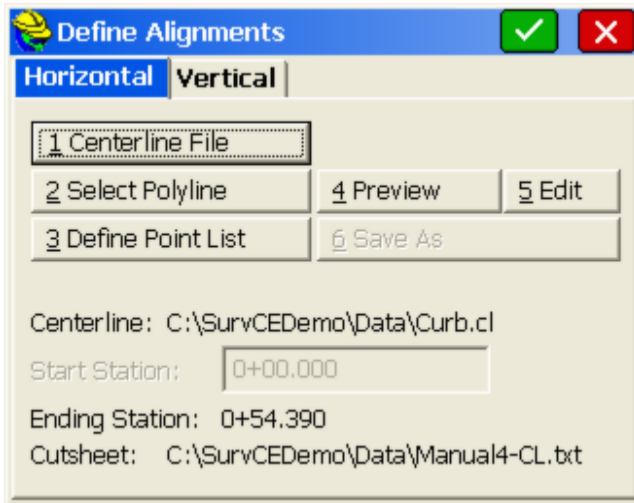

- **Centerline File:** Select a centerline file defined in the Roads Menu or uploaded and converted to “.cl” format.
- **Select Polyline:** Select a polyline on the screen to define the alignment.

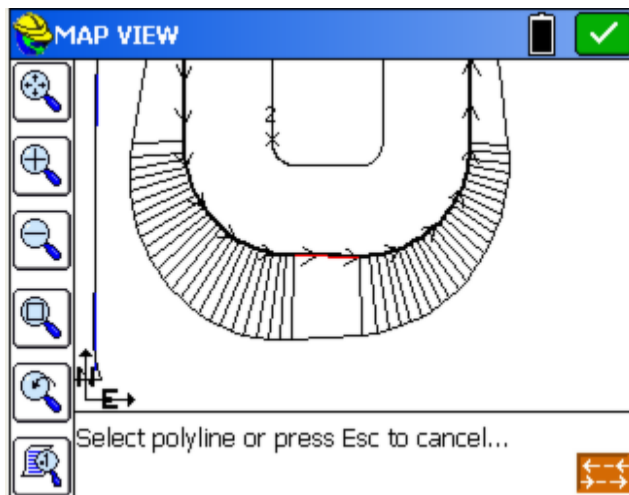

 **Reverse Alignment Direction:** After selection of a polyline, you can use the "Reverse" icon to reverse the direction of the alignment, ensuring that it increments the stationing in the desired direction. This feature is found throughout the software where horizontal alignments are selected from the screen. In the case of File-based or Point-based alignments, the direction is defined by the file or point order itself. This option is available within Stake Offset, Point Projection, Station Store, Store Sections, Stake Slope and Stake Road.

- **Define Point List:** Enter a sequence of points to define the alignment.

- **Preview:** Displays the alignment graphically, highlighted as a bold line.
- **Edit:** Use this to edit the selected alignment.
- **Save As:** If an alignment was defined by points or a polyline, you can optionally save it as a centerline file.
- **Start Station:** Enter the starting station unless it was pre-determined by a centerline file.
- **End Station:** This shows the ending station of the selected alignment.

Defining Alignment (Vertical)

This is optional in this command. If your goal is to ignore elevations and you are auto-recalling roading files, the Vertical Alignment will be used and cut/fill will appear unless you turn off **Apply Vertical Alignment**.

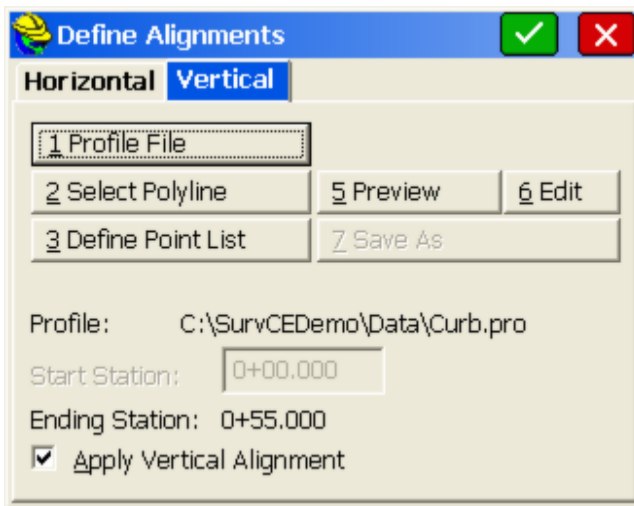

- **Profile File:** Select a profile file defined in the Roads Menu or uploaded and converted to “.pro” format.
- **Select Polyline:** Select a 3D polyline on the screen to define the profile.
- **Define Point List:** Enter a sequence of points that have elevations to define the profile.
- **Preview:** Displays the profile graphically.
- **Edit:** Use this to quickly edit the selected profile.
- **Save As:** If the profile was defined by points or a polyline, you can optionally save it as a profile file.
- **Start Station:** Enter the starting station unless it was pre-determined by a profile file.
- **End Station:** This shows the ending station of the selected alignment.
- **Apply Vertical Alignment:** Toggles on/off the vertical alignment for 2D or 3D staking.

Note: For file names to be recalled, **Recall Job Road Files** needs to be enabled within **Job Settings, Options**.

Shown below is an example of what will you see when you tap **Preview** in either tab. Notice that the centerline is shown, along with any existing point numbers in the vicinity.

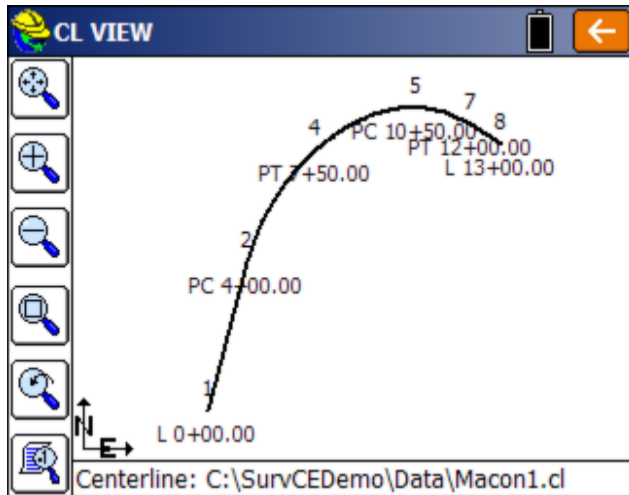

With Stake Station Interval On, the alignment selection screen continues into the Station/Offset screen where you select your station and offset to stake out. Using Define Alignments, the Point on Line option becomes Point on CL in the screen that follows. With both horizontal and vertical alignments defined, the final stakeout screen (eg. station 375) includes cut and fill values. Shown below is an example in GPS mode. The centerline was picked from the screen (Select Polyline) and the vertical alignment was selected from a file.

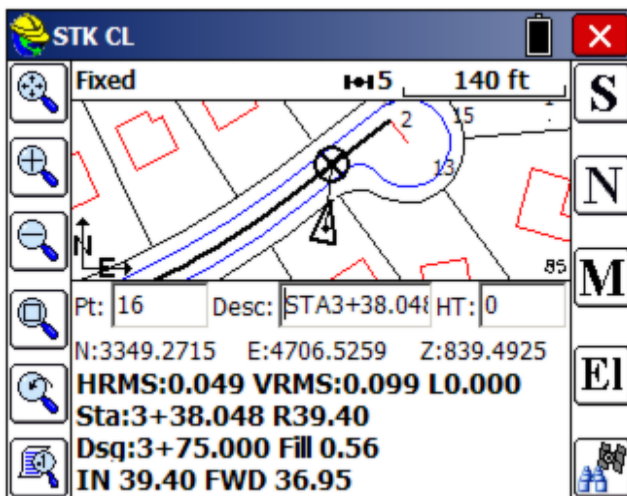

Stake Station

Interval On

Reference Centerline Example

If a Master Centerline or "Reference Alignment" is used and Stake Station Interval is Off, and "Use Reference Centerline to Display Station and Offset" is on, you will obtain the cut/fill from the target alignment but the Station and Offset, noted with the "*" symbol, from the Reference Centerline:

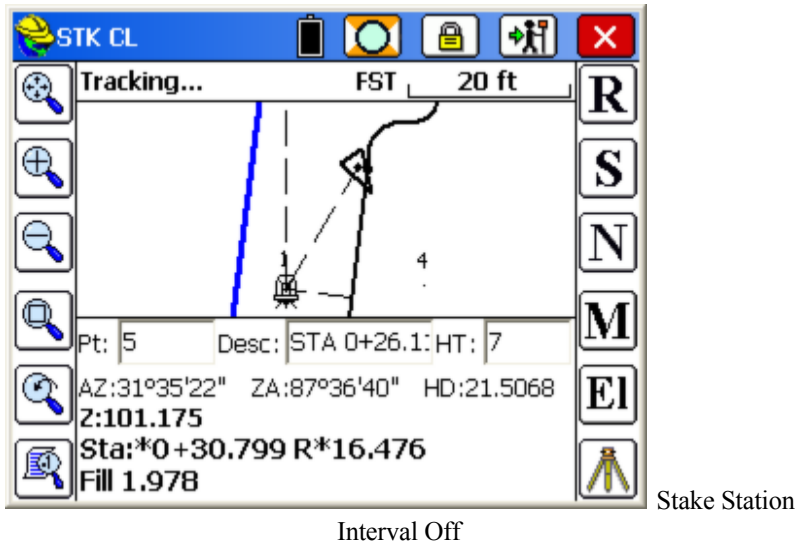

Interval Off

However, with Stake Station Interval On, and in addition, "Use Reference CL to Display Directions" on, the same position shown above is displayed with both current position and instructions to move provided in relation to the Reference Alignment.

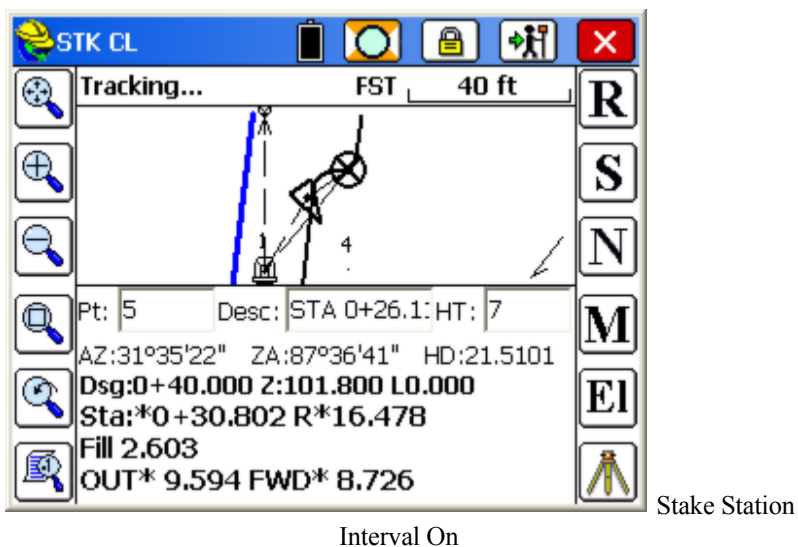

Interval On

The example above illustrates a common use of the Reference Centerline. The bold (blue with color screens) reference centerline may be easier to follow than a curving target alignment such as a curb line. Therefore, the forward and in-out instructions referencing the master centerline may be more useful in moving quickly to the target point. Any display with an "*" designation is in regard to the Reference Centerline. The reason for the difference in fill is that with Stake Station Interval On, the target elevation (101.80) is computed at the target station to stake, whereas with Stake Station Interval Off, the target elevation is computed at the current offset on the target centerline (station 0+26.1, which is the default station in the description field). The Reference Centerline station is 0+30.8).

Define Arc (3 Points)

This routine requests three points to define a unique arc, which is then used for stakeout by station and offset. The first point becomes the beginning of the arc. The prompting is shown below.

The points can be entered in, chosen from the list points button, or selected from the map. After selecting the three points, choose **OK** (green checkmark) to go to the Stakeout Arc dialog. The special stations are limited to PC (start) and PT (end). After choosing a station and offset to stake and selecting **OK**, the main stakeout window appears in map view. In total station mode, an angle to turn to and a distance to go will be displayed at the bottom of the screen. Taking a reading to the current target position will update the display with a new out/in distance and a right/left distance depending upon your job settings. You should see your points and centerline or curve in the map with an icon of the point you need to stakeout to (the circle with the X inside). When using GPS, after selecting **OK** to the Stakeout Arc dialog, you will be placed in the Map screen at your current position with directional instructions to the target point continually updating. You can click "RR" to stake out a 3-point arc by railroad definition. Cuts and fills are computed from the elevations of the points which determine the 3D profile of the arc, and the profile will trend to zero if any of the points have zero elevation. If points are picked using the "snaps", such as when picking the

end of a line, a new point ID will be assigned to the picked point. If this point ID has zero elevation, the profile will trend to zero and will impact cut/fill reports. Points can be assigned elevations using Edit Points. The Reference Centerline and Stake Station Interval options as discussed above apply also to all methods of Define Arc. The Point on Arc option only appears if Stake Station Interval is On, since this option appear in the interval dialog.

Define Arc (PC, PT Value)

This option for defining the arc requires four input parameters: the Start point, End Point, Curve Direction, and any of the following: Radius Point, Radius Length, Arc Length, Delta Angle or Degree of Curvature. The starting station defaults to 0, but can also be changed. See the figure below.

The screenshot shows the 'Define Arc (PC,PT,Value)' dialog box. It features a title bar with a green checkmark and a red X. The 'Direction' section has radio buttons for 'Curve Left' and 'Curve Right', with 'Curve Right' selected, and an unchecked 'RR' checkbox. The 'Start Point' is set to '15', the 'Radius Point' is set to '2', and the 'End Point' is set to '13'. Each of these three fields has a 'Map' button and a 'Pick' button. The 'Start Sta' is '0+00.000' and the 'End' is '0+48.108'.

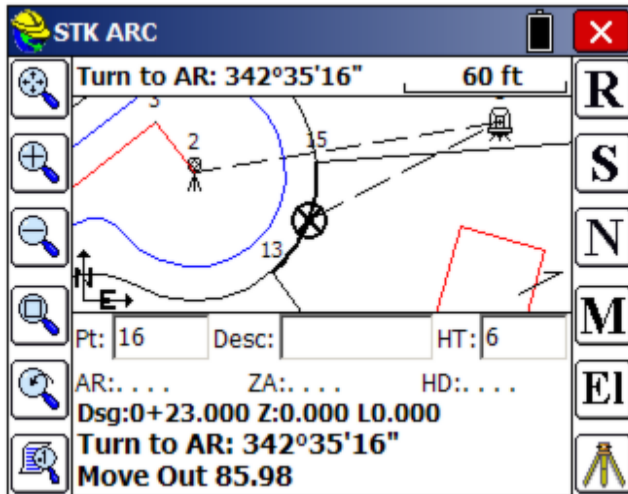

When selecting the PC point, option Radius Point and PT point, enter the point ID, choose the point from the list points screen button, or pick the point from the Map button. When you pick using the Map button, you can pick the point numbers or use one of the "snaps" at the bottom of the screen, like "endpoint snap" and pick a line element. In this case, a new point ID will be assigned to the picked point. After selecting **OK** you will be directed to the Stakeout Arc dialog. After selecting **OK** to the **Stakeout Arc** dialog, the main stakeout window appears in map view. Here we are staking station 75 at 0 offset. In total station mode, an angle to turn to and a distance to go will be displayed at the bottom of the screen. Taking a reading to the current target position will update the display with a new out/in distance and a right/left distance depending upon your reference settings in **Configure Reading**. You should see your points and arc in the map with an icon of the point you need to stakeout to (the circle with the X inside). When using GPS, after selecting **OK** to the **Stakeout Arc** dialog, you will be placed in the **Map** screen at your current position with continuously updating instructions to the stakeout point.



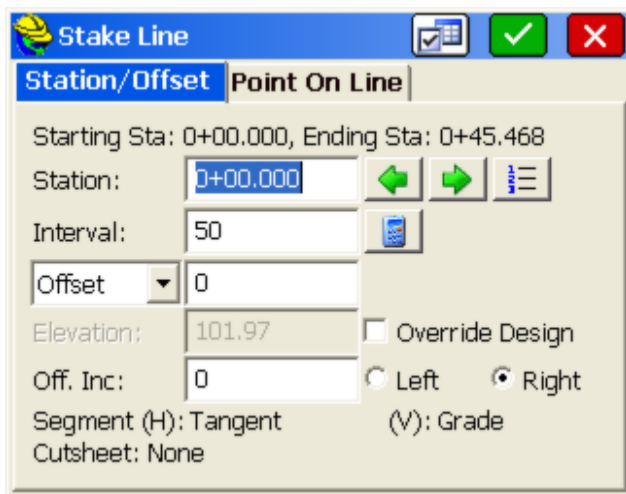

Stake Line/Arc (Station/Offset)

When Stake Station Interval is clicked on, then selecting **OK** on the Define Line, Define Alignments or Define Arc dialogs presents the Stake Line dialog for defining the stake location parameters (e.g. station, offset, interval and even elevation).



- **Station:** This is where you enter the station to stakeout.
-  **Station +:** You can advance to the next station as defined by the alignment points or station interval using the right green arrow icon.
-  **Station -:** You can go back to the previous station as defined by the alignment points or station interval using the left green arrow icon.
-  **Station List:** Select a specific station using the station list icon.

- **Interval:** This is where you choose the distance by which to increment the stations.
-  **Calculate Interval:** This is used to divide the entire line into equal parts, which results in a calculated, non-rounded, incremental station.
- **Offset/Skew List:** This is where you enter in the offset distance from the line. Select one of the left/right radio buttons to determine the offset side. This list also provides additional methods of offsetting, such as Skewed Offsets, Bisectors, Intersections and PI or Radius Points. A Skew Forward angle is measured forward from the perpendicular, and a Skew Back angle is measured back from the perpendicular. So looking forward down a tangent centerline, a pipe with a skew of 70 degrees (in DD.MMSS) from the forward tangent would be a Forward Skew Angle of 20 degrees, as measured forward from the perpendicular (normal) offset.
- **Elevation:** This is the design elevation. If the defined geometry is 2D, then this option will be active.
- **Override Design:** This allows the user to override the design elevation of 3D geometry.
- **Off. Inc:** This is for entering an optional incremental offset along the line. This is a rarely used feature that would trend the offsets away or in to the centerline.
- **Segment:** This defines the current segment of the alignment based on the entered station.
- **Cutsheet:** This shows the currently selected Alignment Cutsheet file.
-  **Settings:** This icon takes you to the Job Settings that apply to alignment staking. See *Job Settings (Stake)* for more details. Note that this is where you instruct the software to include and stop at critical alignment locations.

Stake Line/Arc (Point On Line)

The Point On Line option appears when Define Line or Define Alignments is selected with Stake Station Interval clicked on. The options appear in the Stake Line (Interval) dialog. It offers a Perpendicular to Line method for total stations and GPS. This method projects any shot onto the alignment perpendicular or radial in curves, and prompts for the distance and direction to move to the alignment intersect point. However, only if you select Define Line as the method to define the alignment and you are set to total stations, is there a "Find Intersect to Line" option, which enables "line-of-sight" staking of lines. This is often used by surveyors who are setting line in tree lines, moving to gaps in the trees for readings, then moving in-out along the line-of-sight and driving stakes when perfectly on line. It is useful for any line or boundary staking, such as property lines, right-of-ways and construction lines. For GPS, only the Perpendicular method is available.

Total Stations: The **Offset to Line** option is grayed out when the **Find Intersect to Line** method is selected and available only when the Perpendicular option is chosen.

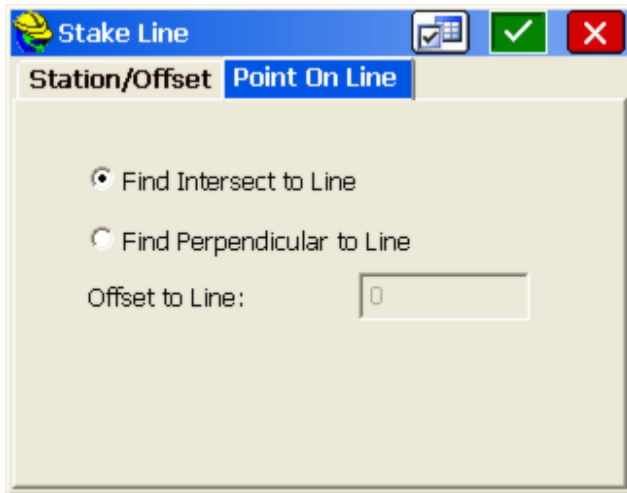

Total Stations, Define Line, Point On Line, Intersect to Line: The Intersect Method is used to set line by moving in or out at the current line of sight. A major application is setting line where the line is largely blocked by trees or obstructions, and you must set the line in gaps where you do have a line of sight.

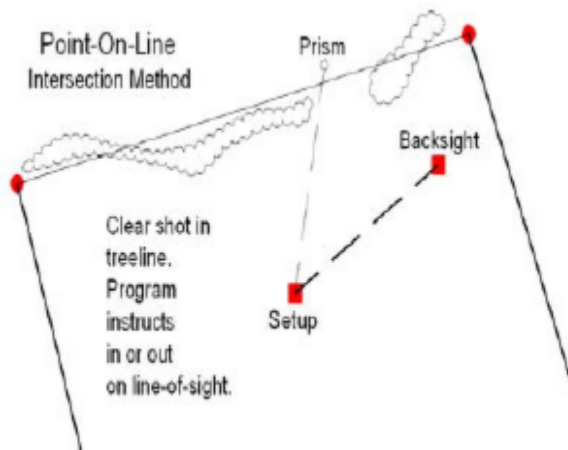

In the Intersect mode, the first screen always displays the target point on the line (or the extension of the line), perpendicular to the setup or station point. When the first reading is taken, the program will display the In-Out distance to the line along the line-of-sight. Regardless of the Reference Centerline settings, the instructions will be In-Out to the target line. However, if Reference Centerline is active, the station and offset to the reference centerline will be shown, with an "*" prefix.

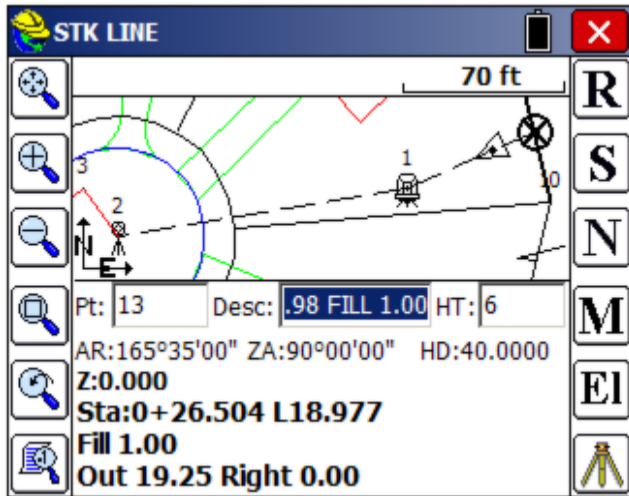

When staking a line defined by points with zero elevation, the cut or fill values will be displayed but should be ignored. Notice that the screen expands to show more graphics by pressing the down arrow key.

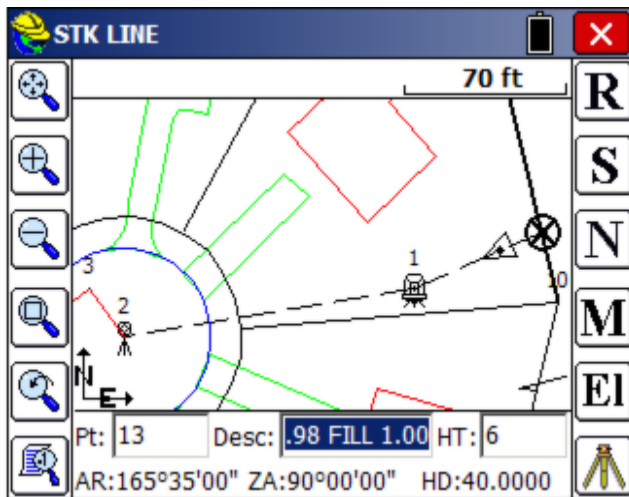

Total Stations/GPS, Perpendicular to Line: When configured for the Perpendicular to Line method, the program will show the direction and distance to move to find the nearest point on the line to the measured point. The instruction received (In/Out versus North/South or Azimuth/Distance) will depend on the setting within Configure Reading.

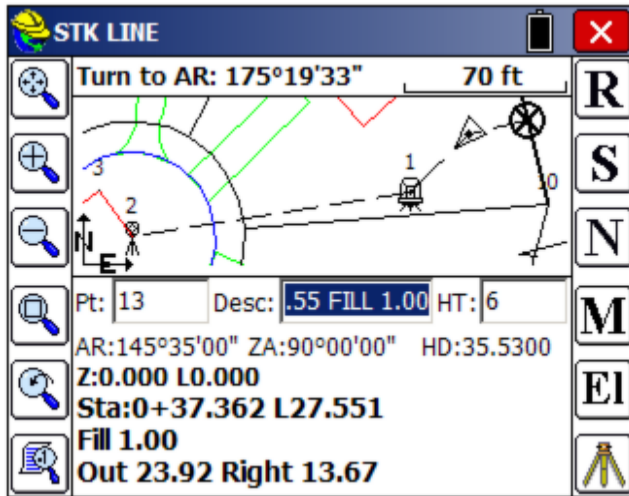

The “Turn to AR” advice at the top of the screen refers to the angle to turn to intersect the defined line at 90 degrees from the instrument location. For GPS, the Point-On-Line screen instructions are similar.

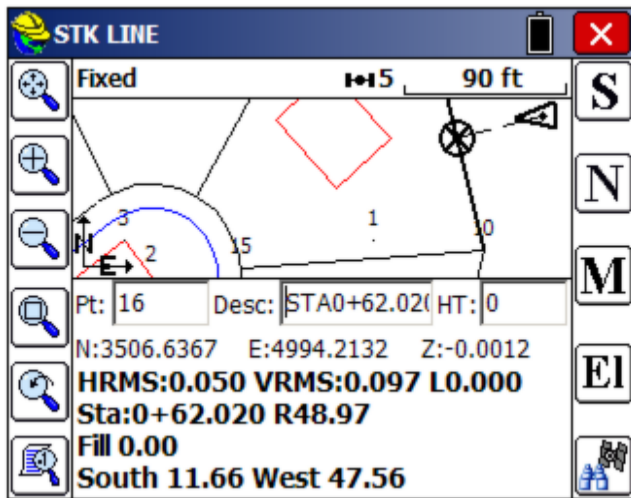

Stake Line/Arc (Point on Arc)

Both the Stake Arc (3 Points) and the Stake Arc (PC, PT, Value) routines have a Point On Arc option similar to the Point On Line option. This appears if Stake Station Interval is clicked on in the opening screen of staking options. In the dialog below, we have chosen to calculate a left 25 offset from the arc. Any measured point will then be translated radially onto the arc that is 25 units left of the specified arc.

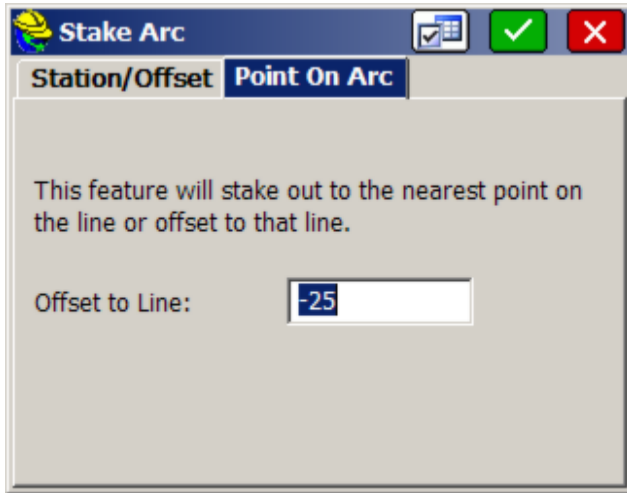

When a measurement or GPS reading is taken, the target point will be radial to the curve, at 25 units offset from the curve, as shown below.

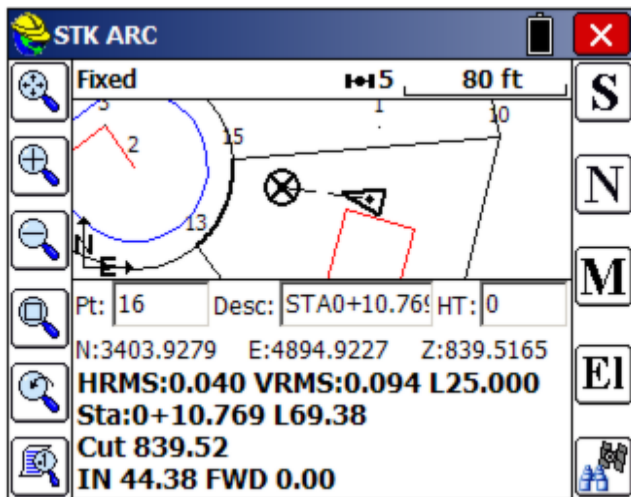

The above example might be useful for setting stakes at a 25' building setback from the right-of-way line. For GPS, information is provided “real-time”. As you move, you see the instructions to contact the nearest point on the arc (or offset to the arc). For total stations, you are first instructed to measure to the nearest point on the arc (or arc offset) from the instrument setup. Then after you take any shot, the instruction refers to that measurement.

Note: The Turn to AR advice refers to the angle to turn to contact the centerline at 90 degrees (right angles) to the instrument setup.

After selecting **OK**, the main stakeout window appears in map view. In total station mode, it will be waiting for a shot or reading. You should see your points

in the map with an icon showing the location of your target (the circle with the X inside).

Note: If the points defining the line are at zero elevation, the program will still report a cut and fill -- in this case a cut from the GPS elevation of 839.52 all the way to zero. If the points defining the line are at a known elevation, the elevation will be interpolated to determine the design and target elevation of the point to stake, and will be applied to a zero offset or non-zero offset stakeout position.

All Stake Line/Arc Options: Store a reading and the coordinates for the Stake Point and the Target Point are displayed. Store by pressing Enter or S to Store. The delta North, East and the elevation difference (Cut/Fill) are also displayed. The **Vert Offset 1** and **Vert Offset 2** allow for elevation calculations based on the input vertical offset values. In English units, a vertical offset of -10" can be entered for example in that form, and the program will auto-calculate -0.833 as the offset. If Vertical Offsets are detected, and a point is stored, you are prompted for additional descriptions for the vertical offsets. If "Alignment Cutsheet" storage is on (as set in Job Settings, Stake tab), an additional cutsheet "row" will be created for each vertical offset. Shown below is a stakeout of station 125, Right 12, and the resulting Report screen.

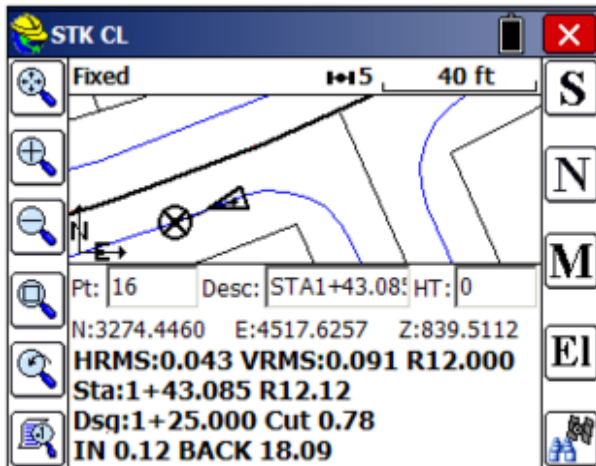

Stakeout Report		
<input checked="" type="radio"/> Show North/East <input type="radio"/> Show Station/Offset		
Northing	Easting	Elevation
Staked: 3268.242	4500.291	839.487
Design: 3268.222	4500.298	838.735
Move: South:0.02 ft		Cut 0.75
East:0.01 ft		
VOff 1: -0.83	Elv: 837.902	Cut 1.58
VOff 2:	Elv:	
HRMS:0.050	VRMS:0.095	PDOP:3.200
<input checked="" type="checkbox"/> Store Point	Point ID: 16	
Point Description: STA1+25.000 R11.98 CUT 0.75		

Note that you have the option to store a point in stakeout. If the point being stored is the same as one in the current job file, the **Point Protect** dialog box appears stating that the point you chose has already been used. The next available point number is listed with the option to overwrite the current point, or use the new number. If you "Show Station/Offset", you will see the Station and Offset of the design (1+25.000 R12.000) and staked point (1+25.000 R11.979), for example.

All cut and fill data, including vertical offsets, will be stored in the Alignment Cutsheet File if named and turned on within Job **Settings, Stake tab, Cutsheets**. Finally, the data is always stored to the raw (.rw5) file as cut/fill (cutsheet) information. If you forgot to create a cutsheet file, you can make a new one, and when formatting the cutsheet, select "Cutsheets from Raw" as one of the options. You can review the cutsheet using the Helmet, View Data option. You can also review the cutsheet with the shortcut, Alt V, from the active stakeout screen. Both will return you directly to stakeout. If using GPS, the HRMS, VRMS, and PDOP values are also displayed, as are Fields for Point ID and point description input. After the point has been stored, you are taken back to the Station/Offset dialog to select the next point for staking.

When you return to the Stakeout Line screen after storing a point, there is a tab option for **Next Alignment** that allows you to define a new alignment, without exiting the command.

Stake Offset

This command will stake out up to two user-defined horizontal offsets to a centerline at any station, as well as an unlimited number of offsets per station, if you are using a predefined Cutsheet Station and Offset List (loaded using the Settings button). It will also stake out the centerline itself. Station intervals can be entered, and the program will auto-detect, at the user's option, special stations such as the TS, SC, PC, PT, CS, ST and vertical curve points (including high and low points). Because individual stations and offsets can be entered, and also

because pre-made station and offset lists can be recalled in the field, Offset Stakeout can be applied to virtually any offset point along a centerline.

Prerequisites and Procedures

Stake Offset requires both a horizontal and vertical alignment. If total stations are involved, **Stake Offset** passes through the normal backsight confirmation screens that Store Points and other forms of Stakeout require.

The Offset Stakeout command is a three-screen routine. The first screen identifies and loads in the alignment files. The second screen identifies the offset points to stake (slopes and distances) and the intervals or lists of stations/offsets to stake. The final screen goes to the standard graphics, shows the target points, and guides you to the destination, with **N** for Next continuing onto the next station in the interval or list.

Identifying the Alignments

The first screen has tabs for selecting both the horizontal and vertical alignments. See *Stake Line/Arc* for more detail.

Settings

Use this button in the upper part of the screen to select predefined station lists and critical stopping points along the alignments.

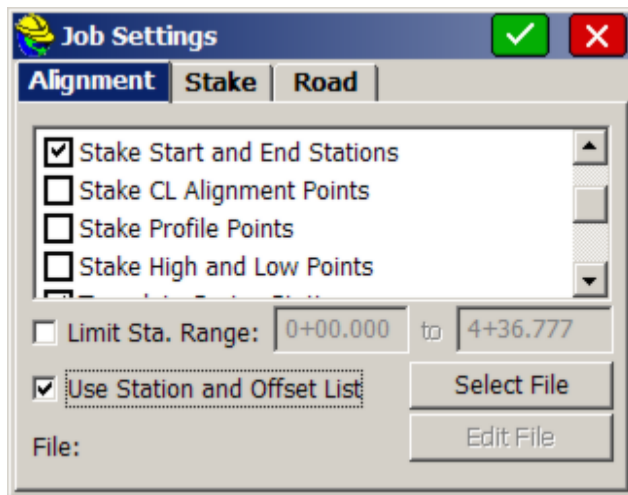

Within this option, you can click the **Stake** tab and edit your default Stake Offset Descriptions shown below. See *Job Settings (Stake)* for more details.

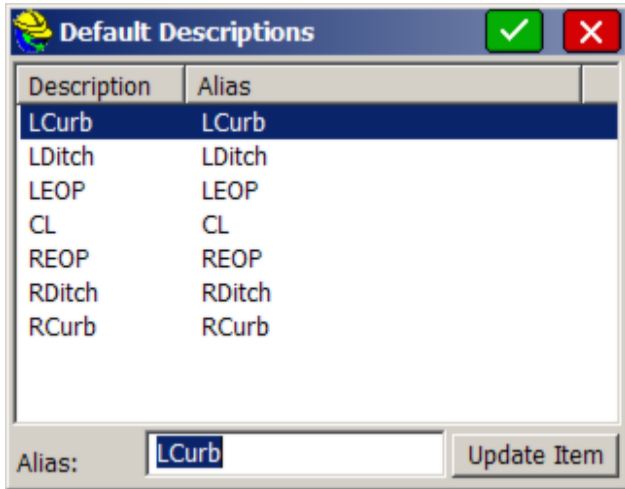

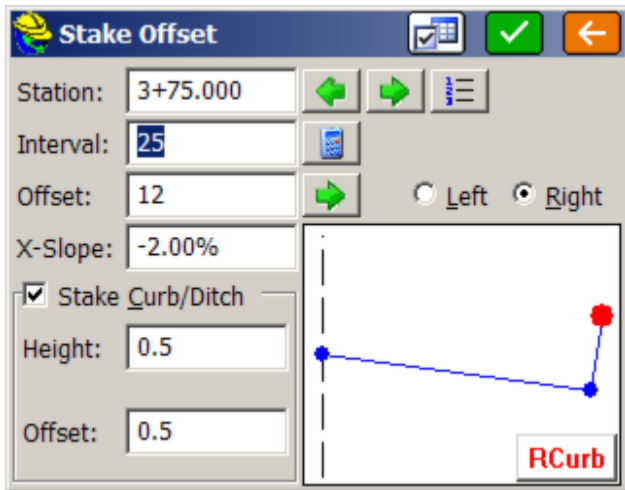

Entering the Offset Points as Slopes and Distances

The Offset Stakeout screen allows you to enter one or two offsets from the centerline. The first offset requires a percentage slope and a distance. The second offset is for a curb or ditch, and is prompted in the form of “distance over” and “elevation change up or down”.





- Settings:** The Settings button returns to the **Settings** dialog, allowing you to load another cutsheet list or specify more or less special stations. Note that in Settings, if you called for a Station and Offset List, then most of the options in the **Offset Stakeout** dialog are fixed, and your only choice is to stake the particular offsets named in the list. Also note that Offset Stakeout, when not using a List, allows for the staking of three points on the Left or Right Side: Center, Curb (or Ditch) and EOP. On the left, it becomes LEOP, LCurb or LDitch. On the right, it becomes REOP, RCurb or RDitch. You must enter data for the right as well as the left if you are staking both sides of a road. So

there are five points total that can be staked when you use the dialog entry, since the centerline is covered in both the Left and Right scenarios.

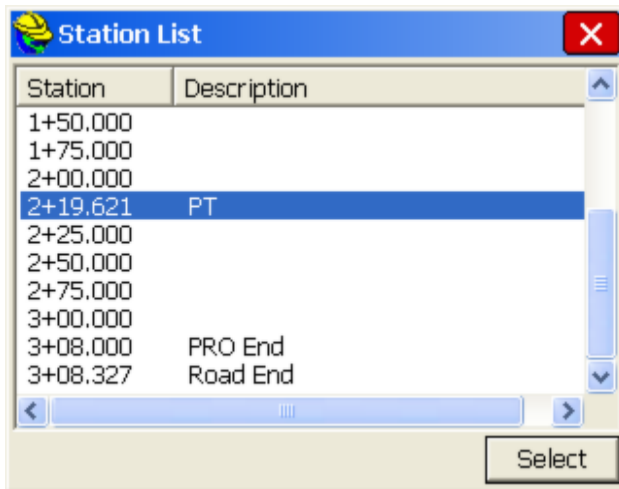
- **Back:** The Back button returns to the first screen.
- **Station:** This is where you enter the station you wish to stakeout.
-  **Station +:** You can advance to the next station as defined by the alignment points or station interval using the right green arrow icons.
-  **Station -:** You can go back to the previous station as defined by the alignment points or station interval using the left green arrow icon.
-  **Station List:** Select a specific station using the station list icon.



- **Interval:** This is where you enter the distance by which the stations should be incremented.
-  **Calculate Interval:** This is used to divide the entire line into equal parts, which results in a calculated, non-rounded, incremental station.
-  **Next Offset:** The green arrow found to the right of the offset entry box will switch from RCurb to REOP to CL and back, and the large solid circle will move and highlight the correct location. These abbreviations are defined in the **Settings** dialog or the Stakeout tab of **Job Settings**.
- **Left/Right:** You can specify whether to stake the left or right side of the road. The offsets are applied symmetrically. If you have a special case on a specific side of the road, do the right and left separately, with separate slope and distance entries.
- **Offset:** This is the first offset from centerline. Units are as configured in **Job Settings** (feet or meters).
- **X-Slope:** This is the first offset slope. Negative represents downhill.
- **Stake Curb/Ditch:** This will allow the user to input and activate a second offset defined by offset distance and height from the first offset.

- **Stake Curb/Ditch (Height):** This is the vertical difference from the first offset to the second offset. A positive entry is interpreted as a curb and a negative (downhill) entry is interpreted as a ditch.
- **Stake Curb/Ditch (Offset):** This is the distance from the first offset to the second (outer) offset.

When using a Cutsheet Station and Offset list, you must select the **List** button, highlight the offset you wish to use and press **Select**. The routine will stay on this offset as it progresses through the stations until the user selects **List** again and specifies a new offset.

The Stake Offset command will store to the Alignment Stakes cutsheet file format if the file is named and made active for storing. The data can include station and offsets as formatted.

Staked Sta	Staked Off	Cut	Fill
1+25.00	Right 12.00	0.75	
1+25.00	Right 12.00	1.59	
3+75.00	Right 12.00	6.08	

Elevation Difference

This routine will report a cut/fill in comparison to a design surface at any location within a project. The **Elevation Difference** command will save cutsheet data if cutsheet files are named and made active within **Job Settings, Stake** tab. For any surface where a centerline is defined (Road Design and Section, or Grid/Triangulation/Elevation with centerline defined), the routine will not only report, but optionally store cuts, fills and centerline position data into an alignment-style cutsheet file. With no centerline defined, the Road, Grid and Elevation methods will store cut and fill data into a point-style cutsheet file. Elevation Difference can also be used with a light bar.

Prerequisites and Procedures

There are five types of data that can be used to define the design surface.

- **Grid File:** You may use a .GRD file that has been created using software packages including Carlson Civil or Carlson Survey. You must transfer this file to the collector via the **File Transfer** routine prior to running this

command.

- **Triangulation File:** You may use a .TIN file created within SurvCE using the **Triangulate & Contour** command found in the **Map** screen under **Tools, Surface**. You can also use a .TIN or .FLT file that has been created in Carlson Civil or Carlson Survey office products, in which case you must transfer this file to the collector via the **File Transfer** routine prior to running this command. Note that triangulation files can be imported from LandXML or DXF format using the command **File, DTM Import**, found in the **Map** screen.
- **Elevation:** You may use known elevation that you specify in the **Set Elevation** field.
- **Road Design:** This method requires a Template, Centerline and Profile file at a minimum, and can utilize superelevation and template transition files.
- **Section:** This method requires a Cross Section file and a Centerline file.
- **Select Type of Surface Model:** Specify the type of surface to be used. With the exception of the Elevation method, the 4 other methods allow the option to specify a vertical offset (such as to subgrade) and lead to a follow-up file selection dialog.
- **Set Elevation:** This option is available when the Elevation method is used for defining the surface model. Enter the desired elevation of your surface in this field.

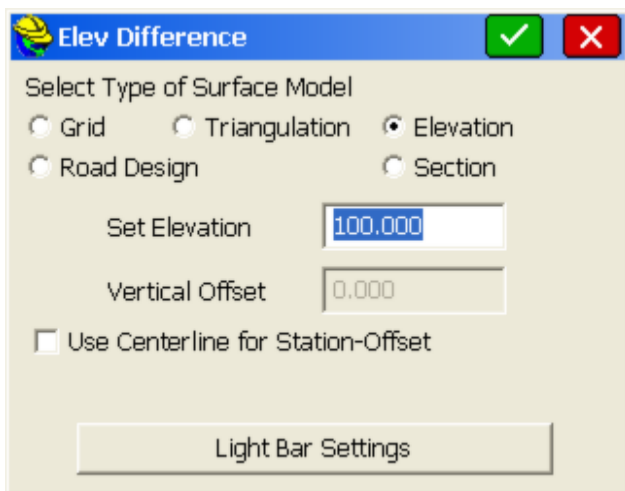

- **Vertical Offset:** This is used in conjunction with grid, triangulation, roading and section files. It allows the user to vertically offset the surface (as defined in the file) by the amount specified in the box.
- **Use Centerline for Station-Offset:** This allows the user to specify a horizontal alignment file (.cl file) for reporting station and offset of your current location to the reference alignment. With total stations this is reported whenever a shot is taken. Using GPS or robotic total stations, with tracking on, your current position is updated in real time as the rover or prism

is moved. This option is available with Grid, Triangulation and Elevation types of surface models. (A centerline is required for Road Design and Section-type surfaces).

- Stakeout Grid Pattern (GPS Only):** The first prompt asks if you want to use the last stakeout pattern. To make a new pattern, you specify, in effect, the lower left corner (“left side” option) or the lower right corner (“right side” option) of a rectangle, and specify the starting point, direction point. Shown in the figure below is a 10x10 layout at 50’ interval (10 rows and columns are added to the starting point, producing 11x11 grid points). The number of cells in the grid ranges from 1x1 to 20x20, and are laid out in a grid beginning at the starting point going towards the direction point.

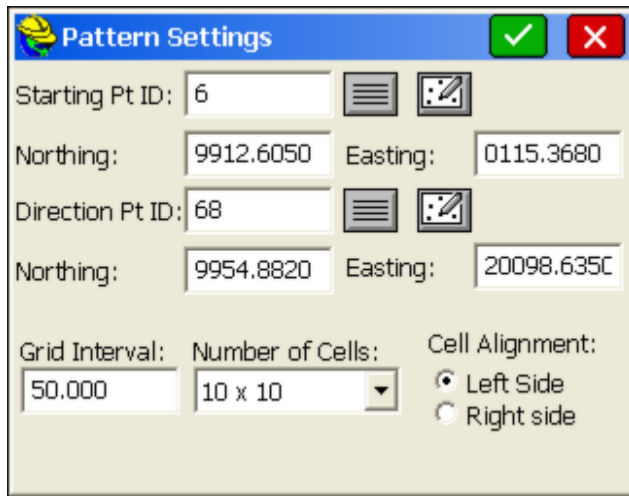

The program will then show the grid point nearest to your GPS position.

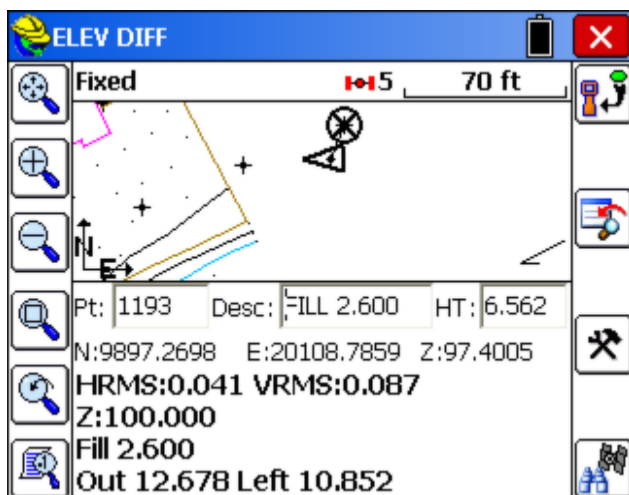

- **Light Bar Settings:** This button allows you to specify parameters for enabling the light bar, setting the grading tolerance, and specifying the COM port. The two light bars currently supported are Mikrofyn and Apache. SurvCE can actually drive the grading process, as shown below, where an Apache light bar is used on a motor grader. In effect, this offers extremely low cost "grade indicate" machine control.



Pressing **OK** from the main **Elevation Difference** dialog will first prompt the user to load the surface files involved (unless elevation method was selected). Then, when **OK** is pressed again, the ELEV DIFF screen in the following figure will appear. This screen provides the user with a plan view of the project. When a shot is taken, cut or fill from the current vertical location to the design surface is reported in the lower left portion of the screen. The computed design surface elevation for your current location is also reported.

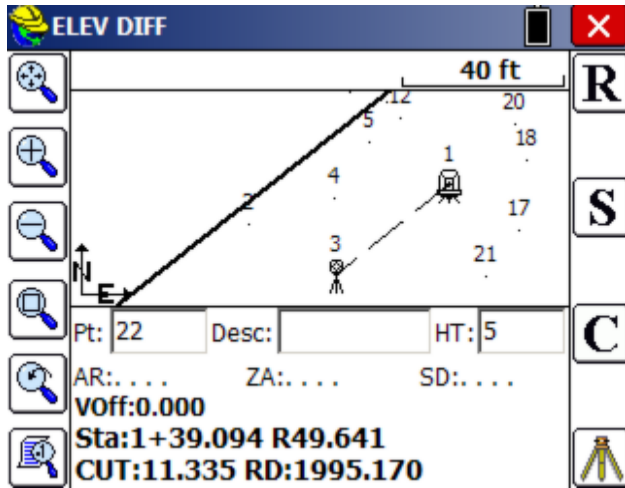

When Road Design Files are selected, there is an extra **Settings** option at the top of the screen that is used for setting the location of the Profile position on the template.

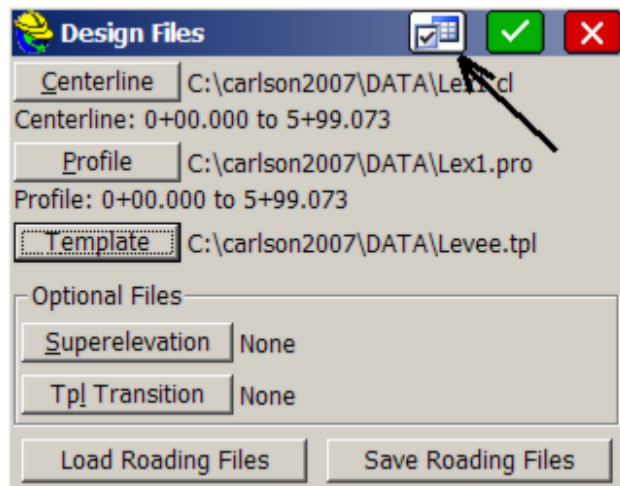

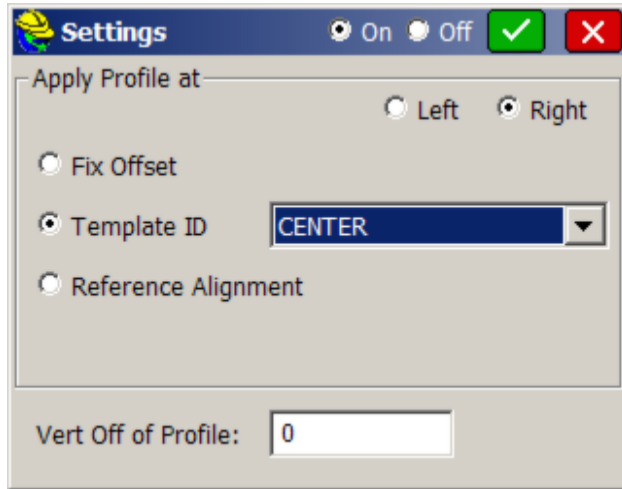

In road design, the position of the profile is sometimes placed on an inside edge-of-pavement or at some other offset from centerline, as defined by a fixed offset, a template ID or even a completely distinct reference horizontal alignment. Even when specified, the application of the special profile can be turned off and on. Note that the "Off" status is equivalent to the default condition of profile grade at Template ID "Center". If the Profile positioning is set to "On" in Settings, you will always be prompted with the Settings dialog after loading the Roding files, so that you are reminded of any unusual, active profile offset before continuing by pressing Enter (OK) or changing a setting.

If you click the helmet icon in the upper left of the screen and select **View Data** from the Help options, or enter Alt V, you can select **Cutsheets** and the **Edit File** option to review the stored cut and fill data at any time, assuming a "cutsheet" file has been named and set active. The data might appear as follows:

Staked Sta	Staked Off	Stake Elev	Cut
1+39.09	Right 49.64	2006.51	11.34
1+43.25	Left 23.06	2005.87	10.45
1+29.37	Right 11.39	2007.84	13.26
1+29.73	Right 1.06	2006.55	11.83

The order of the columns in the cutsheet is set by the user when the cutsheet file is named. In this case, the "Use Centerline for Station-Offset" was clicked on, and the shots were stored to the "alignment-based" cutsheet because a centerline was active. All shots were cut, so if you scrolled right to the fill column, it would be blank. Columns can be extended and compressed by moving the vertical bar between columns. In addition, cut and fill data is also stored to the Raw File associated with the job name. Then when a new cutsheet file is named, you can choose, "Cutsheets from Raw File". For those users who always want a cutsheet file to be made in commands such as Elevation Difference, you can auto-create a new cutsheet with the job name as the prefix, whenever you start a new job, by the following selection within **Job Settings, New Job** tab:

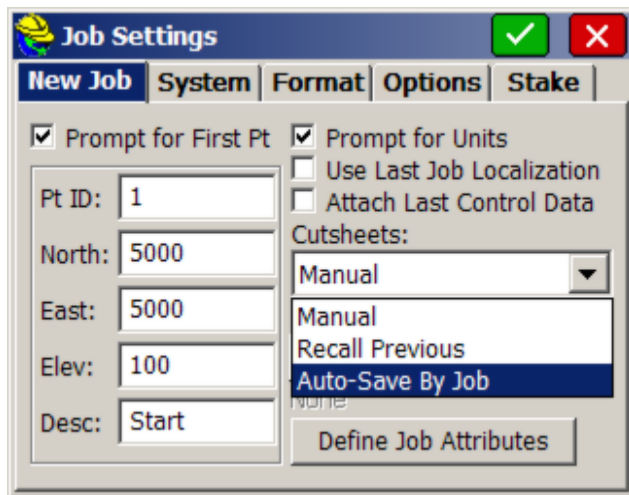

Grid/Face

This command enables points on both vertical and non-vertical planes to be coordinated by angle-only observations. This feature is most often used to pick up details of a building where the prism cannot be placed. You first establish the plane, then take angle-only observations for features such as windows.

The building face is defined by observing three accessible points on the building or by entering their known coordinates. After angle-only observations are made, SurvCE then calculates and stores coordinates of the angle intersection observation with the plane. You can use SurvCE to survey the vertical face of a building or other vertical planes.

Vertical Plane Survey

The **Define Plane** dialog can be accessed by selecting the **Grid/Face** option from the SURVEY tab of the main menu.

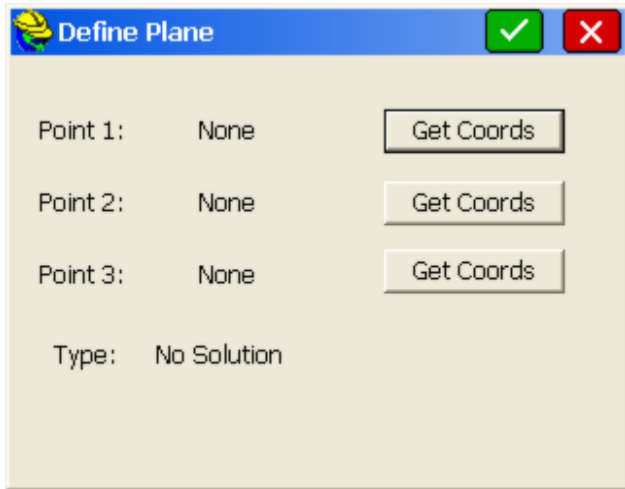

- **Point 1, Point 2, Point 3**: These fields indicate the points that define the building face plane. Both Point 1 and Point 2 must have horizontal coordinates to properly define the building face. For a vertical plane survey, point 3 is not required and can be left blank.
- **Get Coords**: This function allows for three methods to define the coordinates of a point. The coordinates of the points can be manually entered into the Northing, Easting and Elevation fields. Manually entered coordinates will not be stored in the coordinate file.

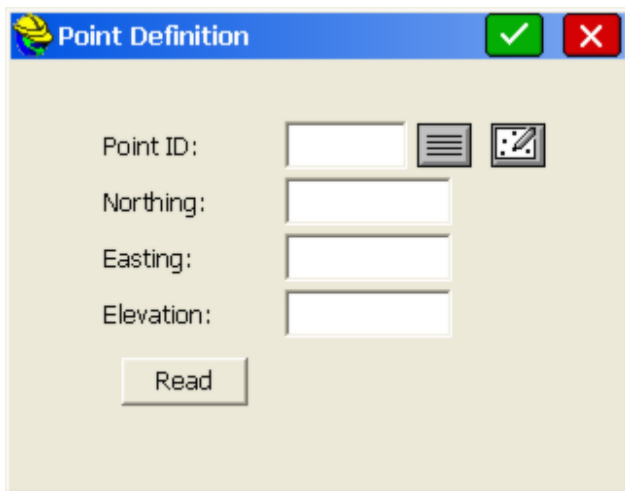

Existing point IDs can be entered into the Point ID field. These points must be defined by coordinate data. As soon as you enter the point ID, press **enter** and the coordinates will appear in the Northing, Easting, and Elevation fields. Existing points can be selected from a points list by selecting the **Point List** icon. Highlight the desired point and press **enter** or tap **OK**.

Pt ID	Northing	Easting	Elevation	De
* 6	9912.60	20115.37	101.970	CF
* 68	9954.88	20098.63	101.081	CF
* 1001	9908.65	20026.32	91.408	CF
* 1002	9869.11	20070.50	99.370	F2
* 1003	9856.99	20043.96	96.610	F1
* 1004	9847.63	20023.31	94.688	F1
* 1005	9840.09	20007.33	93.389	F1
* 1006	9830.64	19987.06	92.891	F1
* 1007	9847.18	19978.40	90.340	F1

Existing points can be selected from the map screen by selecting the **map** icon. To select a point, tap it on the screen. If two or more points are close together on the screen, you will be asked to select the intended point from the point list.

Lastly, the points can be taken with the total station by pressing Read.

After you have specified the two defining points for the building face plane, SurvCE will determine the available solution. One of the following messages will be displayed in the dialog box.

- **Vertical** - SurvCE has enough data to fix a vertical plane (the vertical example is shown in this above figure).
- **3D** - SurvCE has enough information to fix an arbitrary plane.

Press **OK**, and the following dialog will appear. The building face or vertical plane is drawn as a solid line, and any measurement taken by angle only reading (eg. angle right of 270, zenith angle of 83 degrees), will plot as a point with calculated x,y,z position, such as point 20.

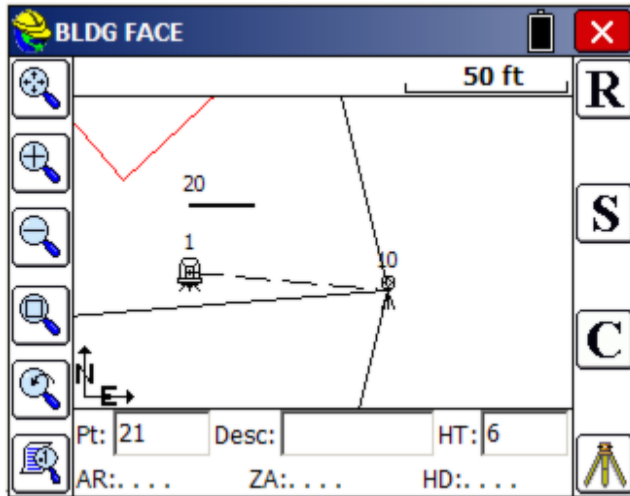

Non-Vertical Plane Survey

Surveying a non-vertical plane is similar to surveying a vertical plane. Once the plane has been defined, picking up detailed observations follows the same general process detailed above. All three points must be defined for a non-vertical plane survey. When defining a non-vertical plane, the three points cannot be in a line.

Resection

This command allows you to calculate coordinates of an unknown instrument setup point given the angles and distances from up to 20 distinct reference points. The reference points are recalled from your working job file. If a control file is active in **Job Settings**, and the entered point ID is not found in the current working coordinate file, then the point will be recalled from the control file automatically. You can also access points from the control file by using the **from list** icon.

Direct and Reverse measurements can be activated within the **Configure** screen in Resection. The options within Configure expand (eg. for "Auto Turn" capability) if you are using motorized or robotic total stations versus conventional total stations. If you choose **Direct & Reverse**, then the reverse measurements count as part of the 20 allowable measurements, so the maximum number of reference points becomes 10. As long as you have at least 2 distinct points, you can shoot the same point twice or more with a direct or D&R measurement.

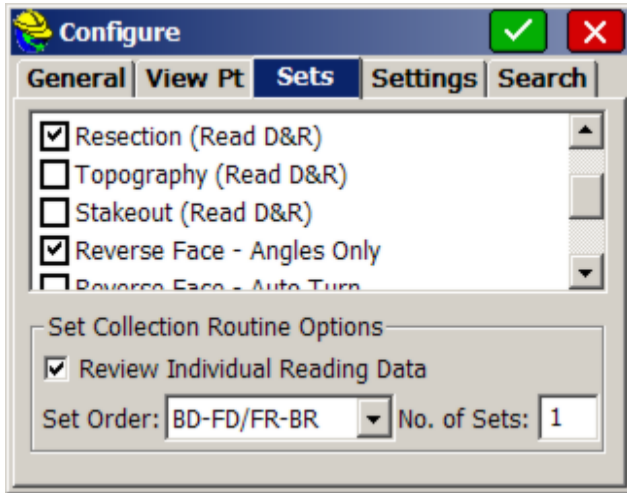

Elevations can be ignored on any measurement. Angle Only Readings can be mixed in as well. This is useful when sighting radio towers and church steeples with known coordinates. In fact, all of your resection points can be measured by angle only, in which case 3 or more points are necessary for an accurate calculation. Sometimes if the 3 angle-only points are in the same quadrant of view, a solution won't be found, requiring additional points. When elevations are used, measurements will contribute to the calculation of the setup point elevation. After entering the routine, the first screen appears as follows:

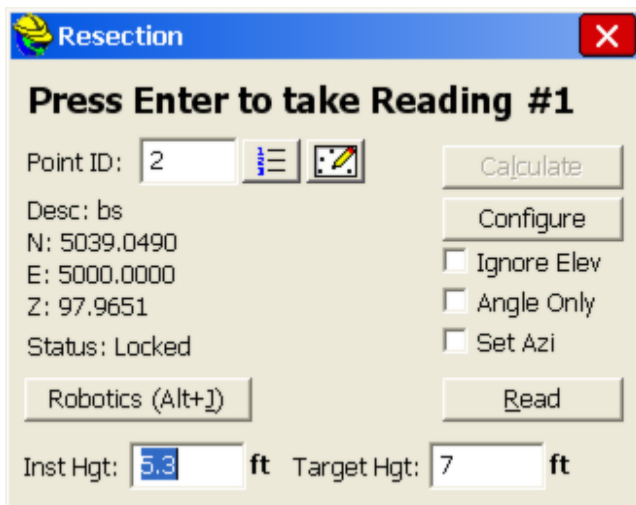

The points can also be selected from the point list or directly from the map screen by pressing either the list or map icons. You will also be prompted for the Instrument Height and a Target Height. On reading #1, you will be asked if you want to Set Zero on the first resection point (optional). If you don't Set Zero, the current azimuth of the instrument will be used. If you click on "Set Azi" then you will not be prompted to Set Zero and when the resection is complete, the

known resection points will be used to set the correct azimuth in the instrument. The Robotics and "Status: Locked" displays only appear with motorized and robotic total stations. Reflectorless measurements can be taken in Resection by clicking the helmet icon, and then clicking on the Target Type option, which switches back and forth from prism to reflectorless.



If you press **Configure**, you can set standard errors for the measurements, as shown below. These settings allow you to take advantage of network least squares and weighting in the calculation performed by SurvCE. The default values are shown. You can also enable **Direct & Reverse** measurements here, in addition to using **EQUIP, Configure**.

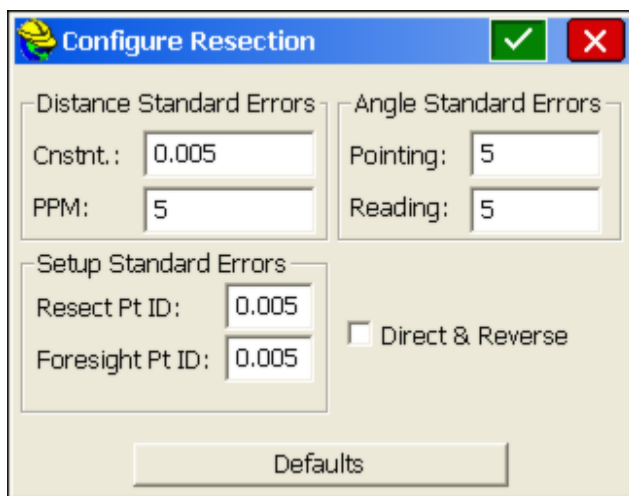

Press **Read** when you are ready to take a measurement. The angle right, zenith angle, and slope distance are recorded.

Repeat this process for all measurements of the resection. After the second measurement, there is enough information to conduct the resection calculation, so the **Calculate** button at the top of the dialog becomes active and can be selected. If you select Calculate, you can review the data, then return to taking more shots by hitting back arrow rather than OK, which would prompt to store the point. After selecting Calculate, if you intend to measure to additional resection points, you have the option with robotic and motorized total stations to automatically turn to those points, as shown below:

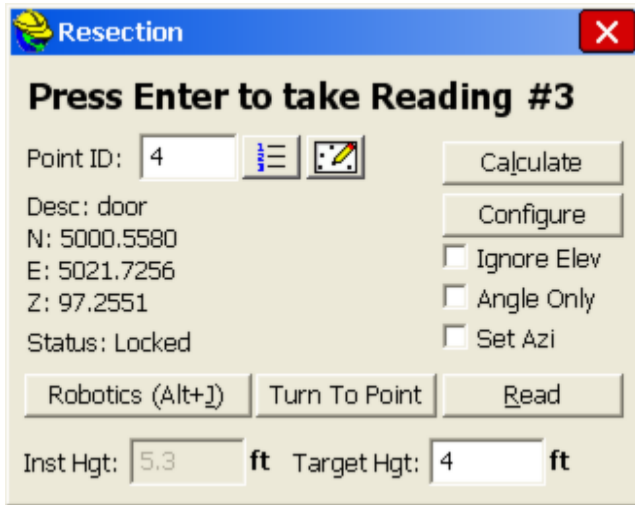

If you select Turn To Point, you go to the standard Turn to Point dialog that is used in Stakeout, and you can Search after the Turn and Turn to Vertical (recommended) to be directly on the desired target point. Be sure to set the correct target height for the additional resection points.

Using the Robotics option, you can go to Settings and change the prismconstant for distinct measurements. With non-robotic total stations, the Robotics button changes directly to a Settings button, allowing changes as shown below. The prism constant in the FS setting is what is used for all Resection measurements.

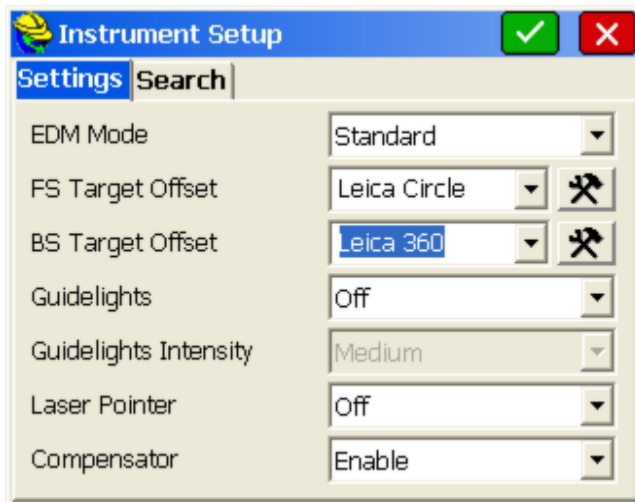

Any time Calculate is selected, the Review Resection screen appears. The input data is displayed in a list structure, and you have the ability to turn certain measurements on/off and recalculate the solution, without the necessity of re-measurement. You can also edit point numbers, instrument and rod heights,

and more here. When satisfied with your edits and the solution, you can store the results of the resection.

Since there is redundant data, the final calculated coordinate differs slightly from the individual measurements. The command reports the calculated coordinate's northing, easting, and elevation, and the difference between the calculated coordinate and the individual solutions as residuals, which indicate the quality of the data. High residuals suggest a problem with the input data. If you select the red X in the Review Resection Screen, you are returned to the Read screen in case you want to collect more shots. Here in the Read screen you can truly Cancel if that is your intention. Shown here is a resection to 2 points using D&R (direct and reverse), with angle only in the reverse face. Note that even in a 2-point resection, a closure calculation is presented.

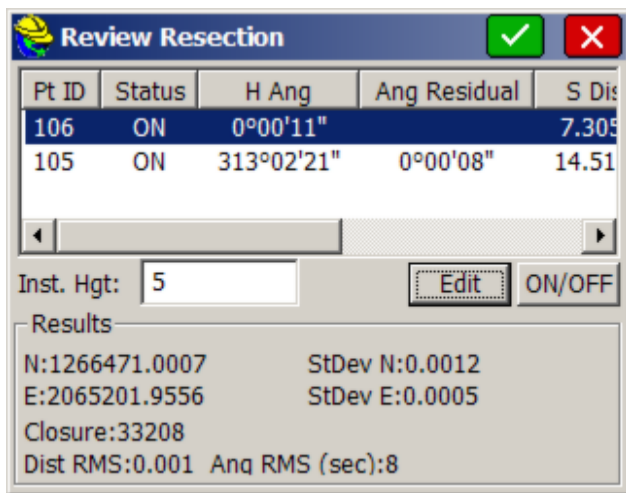

In the “**Store this Point?**” dialog box shown below, you are prompted for the point number and description of the calculated point (the occupied station/setup point). With three or more resection points, residuals are presented showing the accuracy of the calculation. When you press **OK** from the “**Store this Point?**” dialog, you will be setup on the calculated point backsighting the first point measured in the resection.

Store this Point?

North: 4999.9867 Ang RMS(sec): 104
 East: 4999.9989 Dist RMS: 0.037
 Elev: 99.9999 Elev RMS: 0.000
 StdDev N: 0.0242
 StdDev E: 0.0285

Point ID:

Description:

A minimum of 3 angle-only measurements can also lead to an accurate calculation of the resection point, as shown below:

Review Resection

Pt ID	XY On	Z On	H Ang	S Dist	Dist Resi
7	ON	ON	0°00'02"	0.0000	0.000
6	ON	ON	185°38'20"	0.0000	0.000
5	ON	ON	160°18'43"	0.0000	0.000

Inst. Hgt: Edit ON/OFF

Results

N:4999.9943 StDev N:0.0000
 E:5000.0025 StDev E:0.0000
 Z:99.9993 Z RMS:0.0024
 Dist RMS:0.000 Ang RMS (sec):0

Select the Angle Only toggle before taking an angle only measurement with no distance. If the angle only measurements are accurate in the zenith angle to a specific location, an accurate elevation can also be calculated from as few as 3 angle only measurements with no distances. Within Angle Only mode, you do not need to change to reflectorless mode, since by definition no distance will be measured. You can stay in prism mode. If measurements are taken to steeples and radio towers and only x,y position is known or the precise elevation point to sight is not known, then only the x,y position of the occupied point will be determined accurately, and high Z RMS values will result.

Set Collection

The Set Collection routine allows you to collect and average sets of angles to multiple foresights.

Setup

The opening dialog is the standard setup dialog shown below that allows the user to specify the instrument and backsight information.

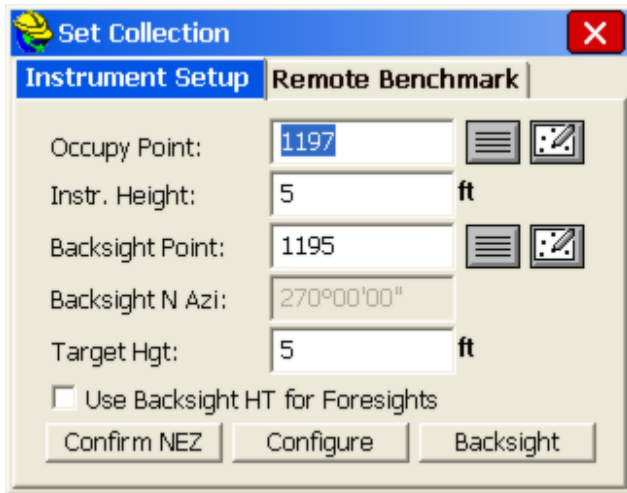

The image shows a software dialog box titled "Set Collection". It has a blue header bar with a yellow and green icon on the left and a red close button on the right. Below the header, there are two tabs: "Instrument Setup" (selected) and "Remote Benchmark". The dialog contains several input fields and a checkbox:

- Occupancy Point: 1197
- Instr. Height: 5 ft
- Backsight Point: 1195
- Backsight N Azi: 270°00'00"
- Target Hgt: 5 ft
- Use Backsight HT for Foresights

At the bottom, there are three buttons: "Confirm NEZ", "Configure", and "Backsight".

- **Confirm NEZ:** This button allows you to quickly verify the instrument and backsight coordinate values.
- **Configure:** This button displays the dialog shown below, and allows you to specify options available for the way the angle sets are to be collected.

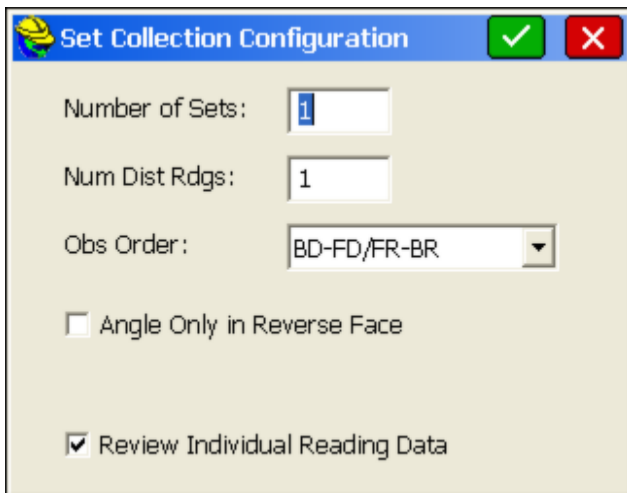

The image shows a software dialog box titled "Set Collection Configuration". It has a blue header bar with a yellow and green icon on the left, a green checkmark button, and a red close button on the right. The dialog contains several input fields and checkboxes:

- Number of Sets: 1
- Num Dist Rdgs: 1
- Obs Order: BD-FD/FR-BR
- Angle Only in Reverse Face
- Review Individual Reading Data

For robotic total stations, the **Robotic Set** option is available.

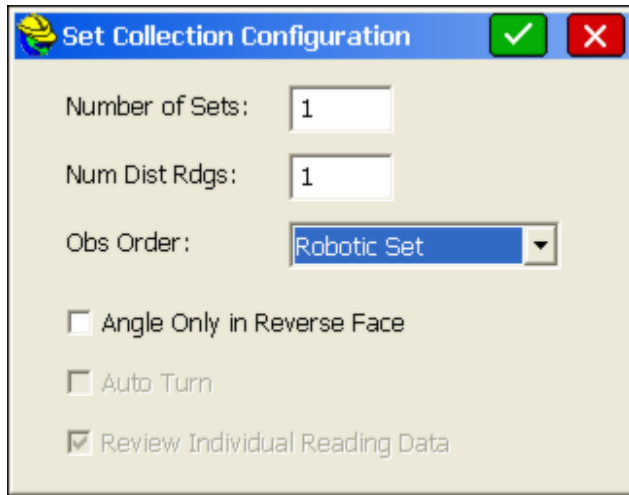

Number of Sets: This input box allows you to define the number of angle sets that are to be collected to each point. An angle set is defined as a direct and reverse reading to the backsight and the foresight (i.e. BD-FD/FR-BR). If multiple foresights are defined, only a single backsight-direct and backsight-reverse set of readings will be collected for all foresight points.

Num Dist Rdgs: This input box allows you to specify the number of distance measurements that are to be taken during each sighting.

Obs Order: This drop list allows you to specify the order the angles are to be completed. The definition for the abbreviations are *Backsight Direct (BD)*, *Backsight Reverse (BR)*, *Foresight Direct (FD)* and *Foresight Reverse (FR)*. Since the backsight dialog is the first reading in all cases, only the following options are available:

Robotic Set: Only available for motorized, auto targeting instruments. This option will turn all reverse sightings without any assistance from the user. The order will be the same as BD-FD/FR-BR.

BD-FD/FR-BR

BD-BR/FD-FR

BD-FD/BR-FR

BD-BR/FR-FD

Angle Only in Reverse Face: This toggle is intended for use with non-coaxial instruments. Only direct face readings will be measured, and all reverse face readings will be for angles only.

Auto-Turn: This toggle will allow the motorized instrument to automatically advance to the next position if it was previously measured. The software will pause at the next location and wait for the user to initiate the reading.

Review Individual Reading Data: This toggle will pause the software after every reading and display the measured data.

- Backsight:** This button is required to initiate the first reading and backsight orientation for the set collection process. The following dialog will be displayed. The user must measure either an angle only or an angle and distance to the backsight in order to proceed with the **OK** button. It is recommended that the **Set Angle** or **Set Angle and Read** buttons be used to record the initial backsight reading.

Define Foresight Points

After the **Backsight** dialog is accepted, the next step in the process is to enter in the point IDs for all of the foresight points that you intend to sight. The dialog shown below is intended to receive predefined point IDs. To enter points, begin in the top left input box and work your way down to the bottom of the left column, then start at the top of the right column and work down to the end.

Take Readings

Once the foresight points have been specified, the next dialog will be determined

by the set order. If the next reading was to be FD, since the BD was already recorded, then the dialog will prompt as shown below. Pay attention to the prompts in these dialogs as they inform you as to which point and which face is expected based on your configured set order. Press the **Enter** button or select the **OK** button to record the reading.



Reading Review

Unless robotic sets are involved, after each measurement an optional **Reading Review** dialog appears where the measurement can be accepted or rejected. This option is set in Configure.

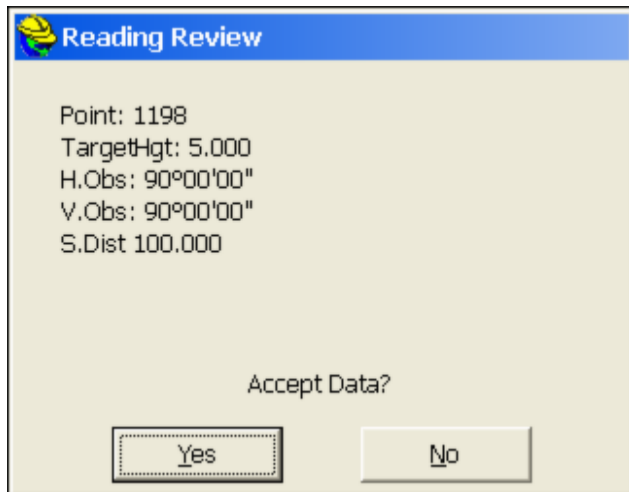

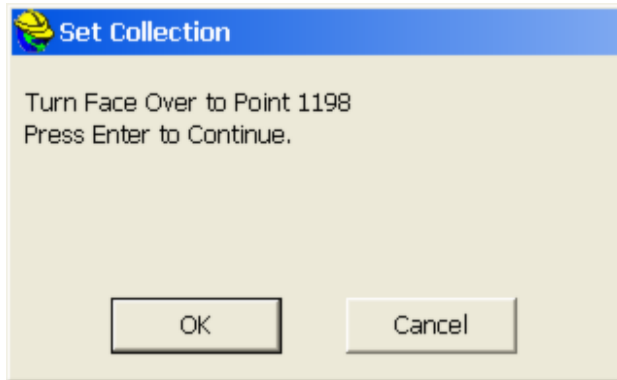

The sequence of shots continues.

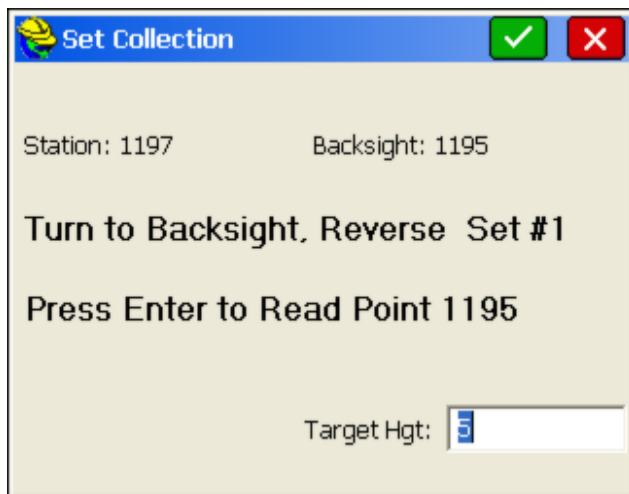
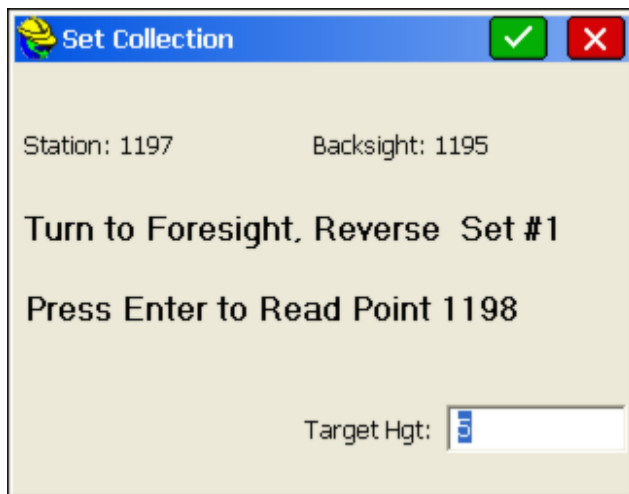

Completed Set

At the end of the set collection process the Set Report dialog will be presented.

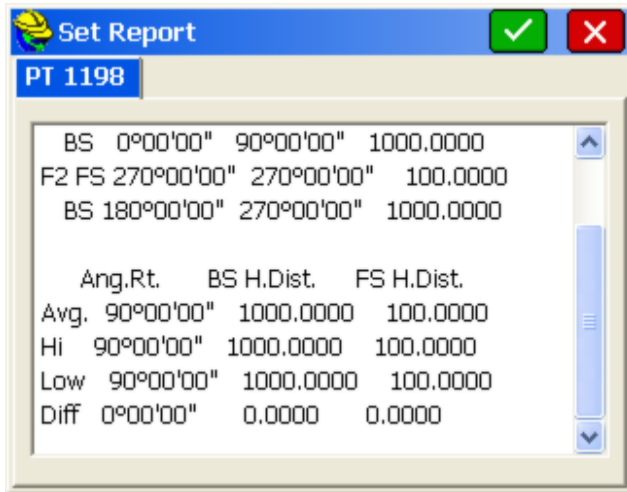

If you had specified 2 points (or more) in the initial "Set Collection Point Order" screen, you would obtain a tabbed dialog of all the points to review.

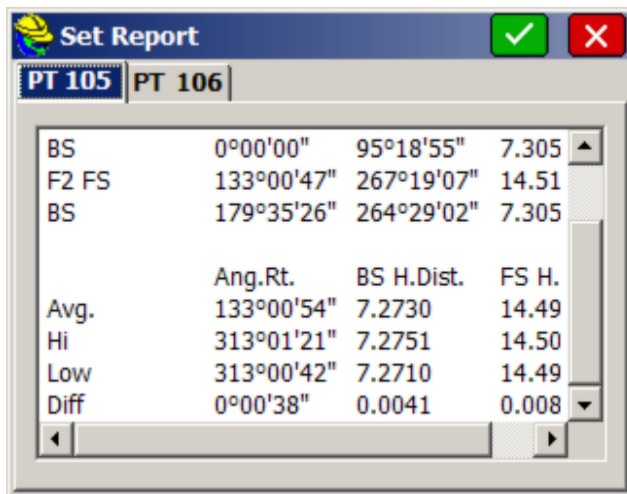

After all of the **Reciprocal Calculation** and **Store Point** dialogs have been accepted, the dialog below will be presented.

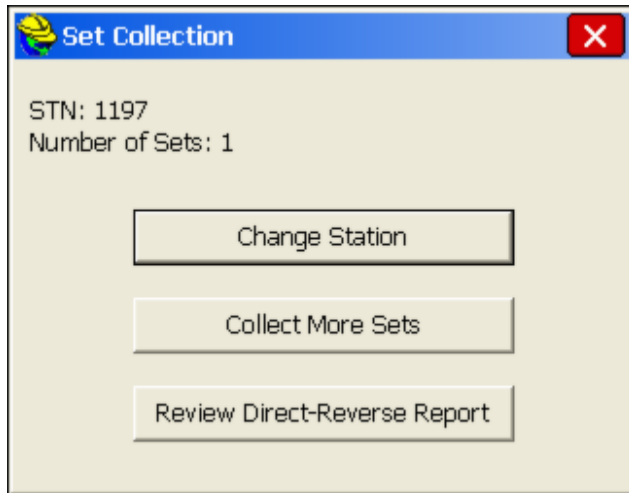

- **Change Station:** This button will take you to the **Instrument Setup** dialog and advance the point numbers so that the original occupied point is the backsight and the last foresight point is now the occupied point.
- **Collect More Sets:** This button will take you to the **Backsight** dialog and maintain all of the previous setup information.
- **Review Direct-Reverse Report:** This button will allow you to select the occupied point ID from a list of points that were used with set collection. The software will then generate a report of all of the sets measured from the specified occupation point.

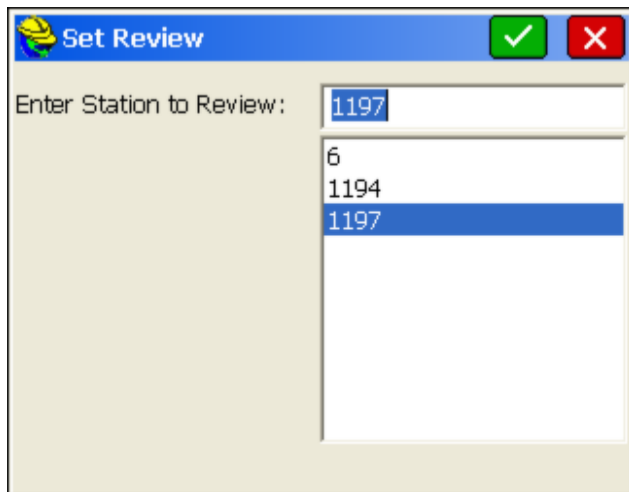

In the figure above, select a point number and tap **OK** to view the report. The report is shown below.

Type	Setup	FSight	HorzAngle	Distance	Vertical
BD	1197	1195	0.0000	1000.0000	90.0000
FD	1197	1198	90.0000	100.0000	90.0000
FR	1197	1198	270.0000	100.0000	270.0000
BR	1197	1195	180.0000	1000.0000	270.0000
Means					
	HorzAngle	HZ Diff.	FS Diff.	BK Diff.	Distance Diff.
	90.0000	0.0000	0.0000	0.0000	100.0000

Leveling

This routine allows you to run trigonometric level loops using a total station or digital level loops using a digital level. There are also manual entry modes available for both types of level loops. The raw data collected for a total station is slope distance, zenith angle and prism height. For digital levels, the vertical difference and if available, the horizontal distance is stored in the raw data file.

The calculation routines assume there is only one loop per level file. A benchmark is required at the beginning of the loop (BM+) and a benchmark is required at the end of the loop (BM-). After the BM+, measurements back to a known elevation (TP-) and measurements forward to establish an elevation (TP+) are alternated. Any number of side shots to points (SS-) or stations (STA-) is allowed while traversing. Spurs (series of TP+ and TP- measurements off the main loop) are allowed and will be adjusted correctly. A spur after the BM- is allowed.

The opening dialog is where you set up the level loop. If road files are used, an additional tab in the leveling measurement screen will be made available for entering station and offset data. To use a digital level instead of the current total station, click the Select button to the right of the Instrument and choose from the available options, which include Manual 3-Wire, Manual 1-Wire, Manual Digital Level and Sokkia SDL. Manual Total Station entry can also be done by choosing **Manual Total Station** on the **EQUIP** tab.

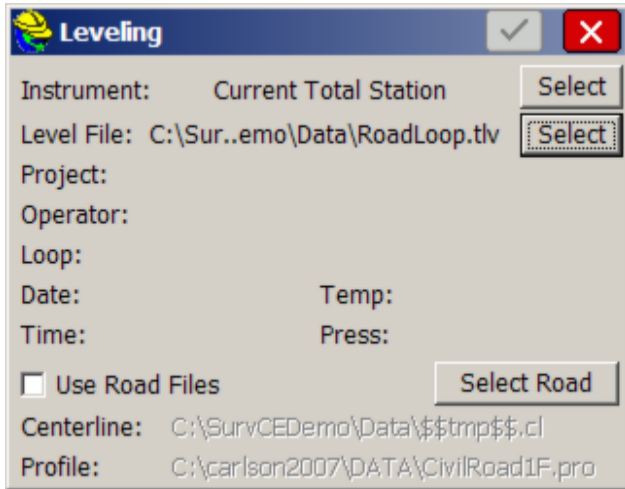

Click the **Select** button to the right of the Level File to open an existing loop or start a new loop. The user will be prompted to enter loop data, such as project name and operator, when creating a new loop.

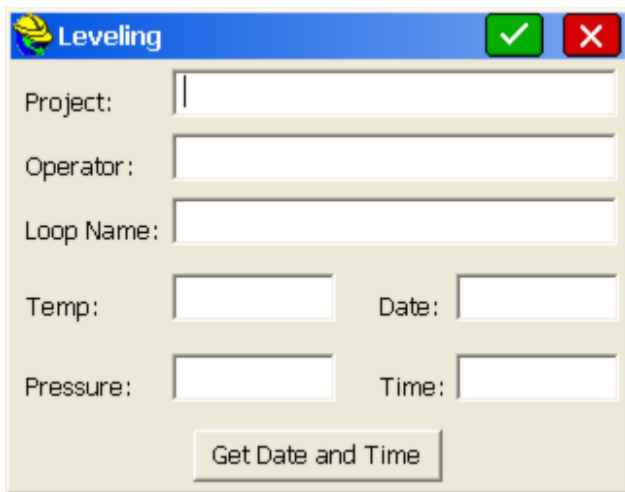

Use the **Select Road** button to choose the horizontal and vertical alignments you wish to associate.

Click the **Use Road Files** toggle to enable the use of the selected files. If **Use Road Files** is turned off, the STA+ tab will not be shown.

After the loop has been opened or created, select the Green Check button (OK) to advance to the measuring screens. The first reading of the loop **must** be a benchmark (plus) reading to establish the instrument height. Enter the point ID or known benchmark elevation, the prism height (trig levels), and a description. Then press the **Read** icon or **Enter** to measure. Once the reading has been taken,

select the **Store** icon to keep it. You can take as many readings on a single point in any face that you like. You can also review the readings, and disable any that you don't like prior to storing.

Leveling

BM +

Pt ID: 6

HT: 5 BM Elev: 101.97

Desc: CP/CHIS X

SD: 7.685 ZA: 91°50'29.1" VDiff: -0.247

Avg Elev: 107.217 Elev Spread: 0.000

Reading Count: 1

Review Readings Robotics

Trig Leveling

Leveling

BM +

Pt ID: 1

BM Elev: 100

Desc: Bench

VDiff: 5.000 HD: 200.000

Elev: 105.000

Reading Count: 1

Review Readings

Conventional Leveling

Some of the fields below only apply to one of the Leveling types. See screen shots above to see which apply.

- **Pt ID:** Use this field to retrieve the elevation from an existing point in the

coordinate file.

- **HT:** Use this to enter the prism height. If using a digital level, this field will be gray, and will be populated with the rod reading from the level.
- **BM Elev:** Enter a known elevation for the benchmark. This field will auto-populate if a point ID is selected.
- **Desc:** Enter the point description.
- **Review Readings:** This allows you to enable or disable specific readings prior to storing.
- **Robotics:** Use this to control the robot.



- **Read:** Use this icon to take a reading.



- **Store:** Use this icon to store the reading.



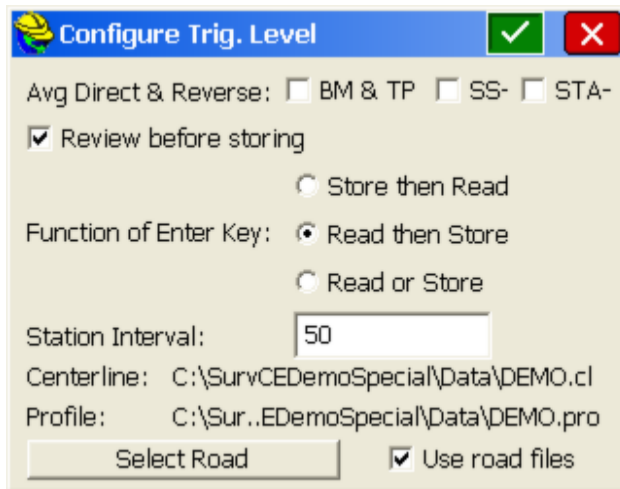

- **Configure:** Use this icon to setup direct and reverse settings and review options.

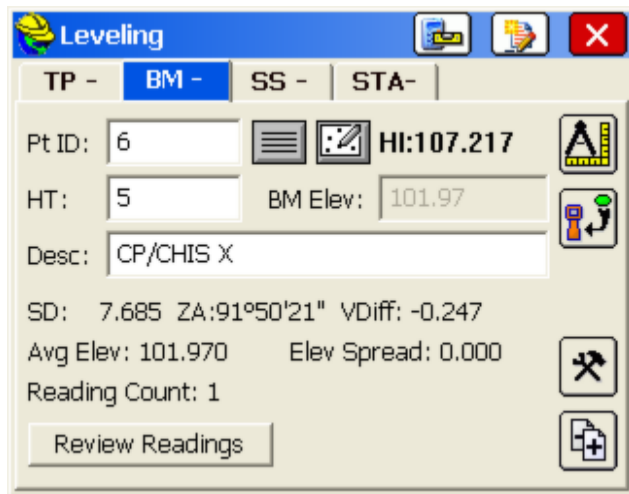

- **Avg Direct & Reverse:** This option will allow you to determine which readings take direct and reverse pairs. (only applies to Trig Leveling)
- **Review before storing:** This toggle forces the **Review Readings** dialog prior to storing. This is the same dialog that comes up when the **Review Reading** button is pressed except the Review Reading dialog has a Store Point button that stores the shown measurements

dialog will be shown. This dialog allows you to read the minus reading to a turning point (TP), benchmark (BM), sideshot (SS), or a sideshot on an alignment (STA). Turning points advance the setup while sideshots do not. A reading to the benchmark in the minus screen will end the loop.



- 

Level Reading Mode: This icon switches the interface between taking plus or minus readings.

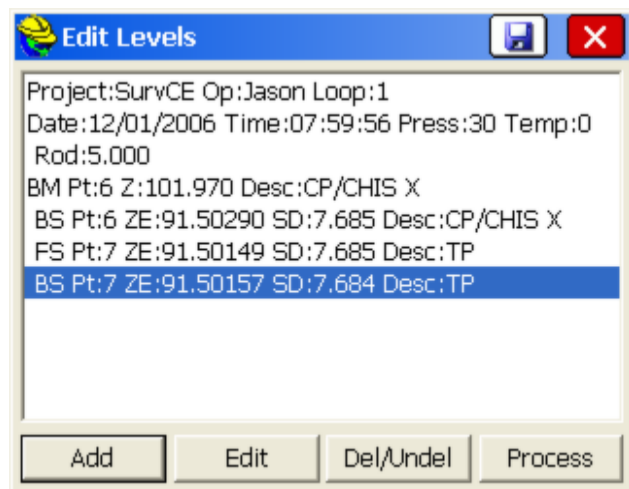
At any time during the loop, you can edit a reading using the **Edit Levels** icon to the left of the red X (Cancel) button.

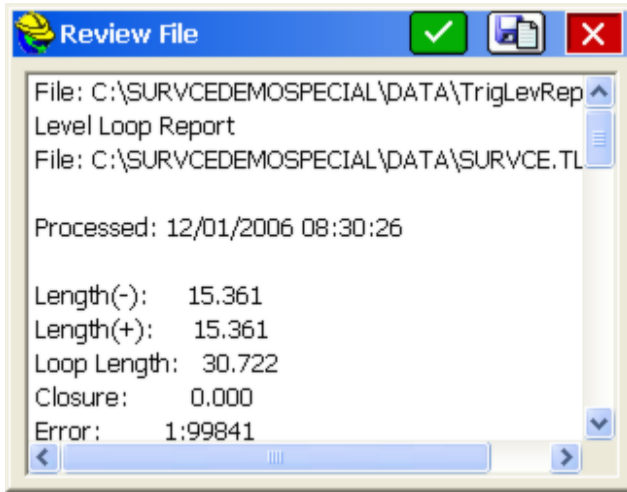

Once the minus reading on a benchmark has been recorded, you can then process the loop using the **Process** icon which is to the left of the **Edit Levels** icon. Once you've processed the loop, a **Review File** dialog will be displayed. At this point

you can choose to save the report or proceed to the **Processing Options** screen.



The Processing Options screen allows you to update all existing points in the coordinate file with the leveled elevations. It also allows you to overwrite the point descriptions using what was entered during the level loop and will compute coordinates for any points that were defined by station and offset.

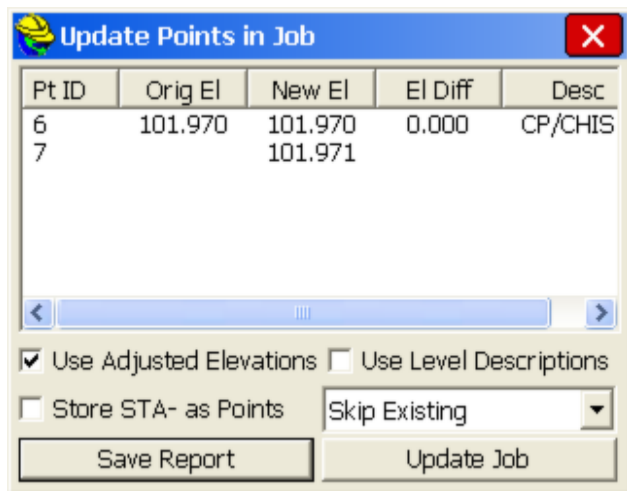

Manual 1-Wire Example

If you select the 1-Wire method of Leveling, the graphic below may be helpful in selecting the options to conduct a simple level loop:

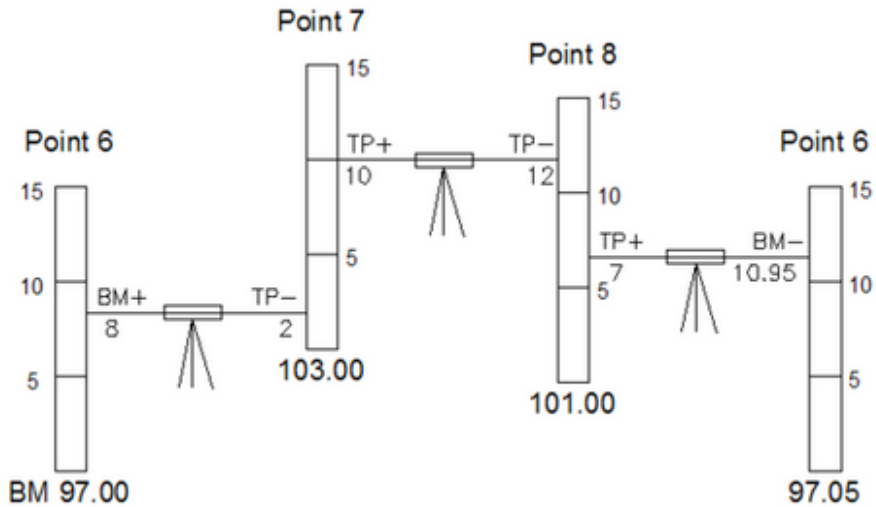

You "+" to your "backsight" and you "-" up to your foresight, and you name the points as you go. You start by referencing a benchmark, and you close the loop by referencing the starting point or a second benchmark.

After entering the example, pressing the **Edit Levels** icon shows all the measurements made. All the horizontal distances (HD) are shown as 100 because 1-wire leveling does not provide a horizontal distance. Giving all the segments the same distance causes the level adjustment to give all the segments the same weight.



Pressing the **Process** icon shows the results.

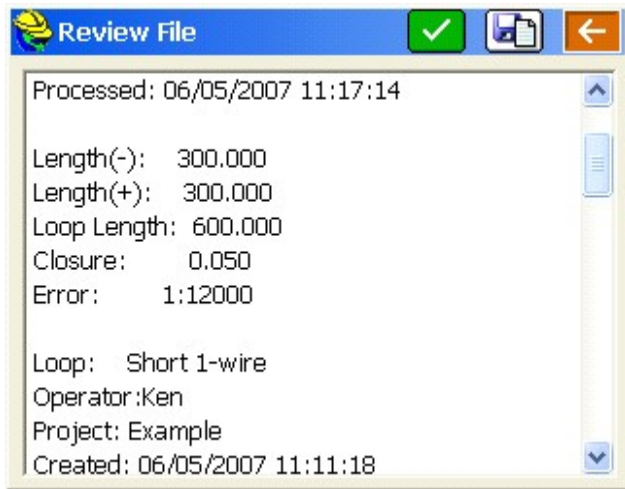

Scrolling to the end shows the adjustments that will be applied to the last two measurements.

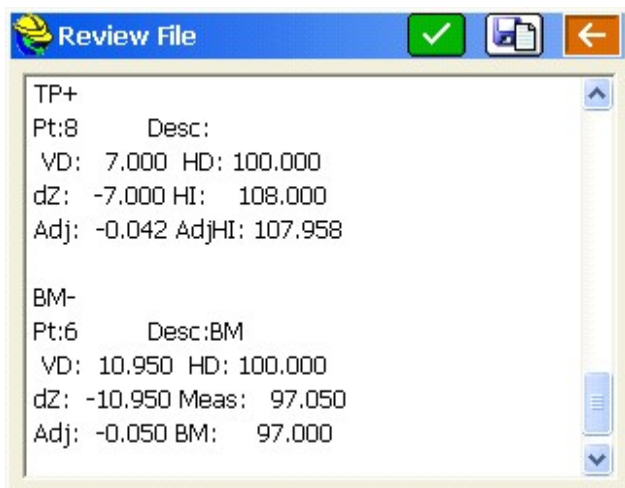

Pressing the green check icon brings up the **Update Points in Job** dialog.

Pt ID	Orig El	New El	El Diff	Desc
6	97.000	97.000	0.000	BM
7		102.983		
8		100.967		

Use Adjusted Elevations Use Level Descriptions
 Store STA- as Points Skip Existing

Save Report Update Job

Save Report will put the information shown in the **Update Points in Job** dialog into a text file for your records.

Update Job saves the new elevations to the points in the job. **Skip Existing** will not replace a point's elevation if it already exists but **Replace Existing** will.

Auto By Interval

Auto by Interval allows you to acquire and store data at a set interval value of either distance or time. This function is available with all GPS or certain robotic total stations only. When the routine is selected using a robotic total station with Prompt for Setup within Configure on, you will be directed to a **Confirm Orientation** dialog, in which you will be asked to confirm your orientation. The opening or main dialog appears as shown below.

Sideshot/Traverse

Instrument Setup Remote BM Robotics

Occupy Point: 1197

Instr. Height: 5 ft

Backsight Point: 1195

Backsight N Azi: 270°00'00"

Target Hgt: 5 ft

Use Backsight HT for Foresights

Confirm NEZ Configure Backsight

After the backsight is confirmed or measured, the **Auto Store by Interval** dialog will appear as shown in the figure below. In GPS mode, you will see the Auto Store by Interval dialog immediately. In the Auto Store by Interval dialog box you set the type of interval (distance or time) and the value of the interval. You also set the starting point number for the data set. You can assign a point description for all points acquired with this command. During actual data collection, you can change the description.

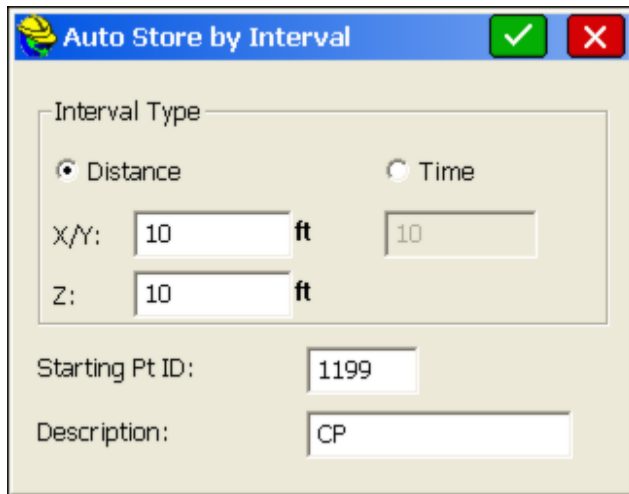

Data is acquired in the standard collection **MAP** view screen. The point ID, description, and rod height fields can all be changed while the command is active. For example, to change your point description from td (top of ditch) to gr (ground shot), simply type "gr" over the "td" in the Desc field without interrupting your collection.

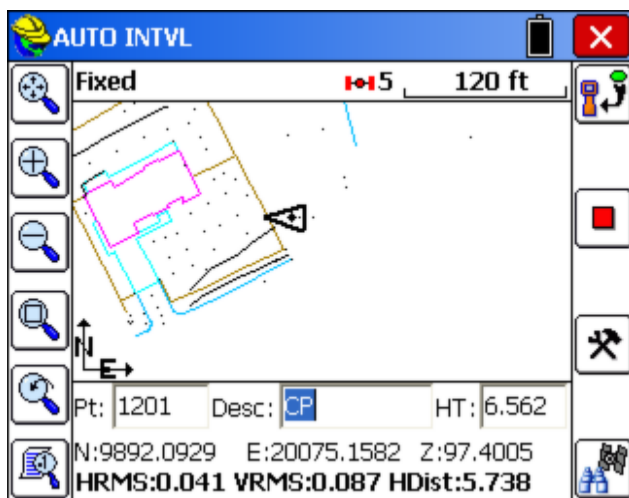

- **Store:** Pressing the **Store** icon immediately stores the point at your current

location, overriding the interval.

- **GPS Start and Stop:** This button alternates between stop (square, red) and play (arrow, green) icons. While the GPS is running or the robotic total station is tracking, the stop icon allows you to stop the surveying equipment from taking readings. When the button is pressed, the GPS or robotic total station stops, and the button switches to the play icon, which can be pressed to resume the readings.
- **Monitor/Skyplot:** This button can be found on the bottom right of the **MAP** screen for GPS. This "binocular" icon opens the **Monitor/Skyplot** dialog.

Note: In GPS mode, if you run **Auto Points at Interval** and points do not store, check that your RMS tolerances for storing are not set too low. Points will be stored only when your RMS values are less than those specified in tolerances under the **EQUIP** tab. Also note that you may find that the points store at a distance apart exceeding that specified by your interval due to latency and your speed of movement.

Remote Elevation

This command allows you to observe a point that cannot be reached vertically, such as a power line, building top, etc. The routine uses two observations - one for the base point and one for the vertical angle to the target object. The routine then calculates the target point's elevation.

By placing the prism below or above the desired point, Carlson SurvCE stores information about the base point. Then you can take a second reading, observing only the zenith/vertical angle to the true target point. Using these two observations, SurvCE calculates the intersection of the extended zenith/vertical angle with a vertical line from the base point to determine the elevation. Reporting includes the elevation of the target object as well as the elevation difference between the prism and the target object.

Steps to take a remote elevation reading are as follows:

1. Select **Remote Elevation** from the **SURVEY** tab of the main menu.
2. Confirm your orientation, and re-shoot the backsight as necessary.
3. Press **Enter** to observe base point (see the figure below). Point the instrument toward the target and press **Enter**.

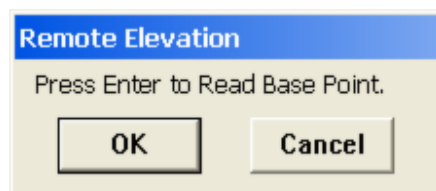

4. Press **Enter** to shoot target elevation (see the figure below). Sight instrument on the desired point (such as a wire or top of pole or point on a building) and press **Enter**.

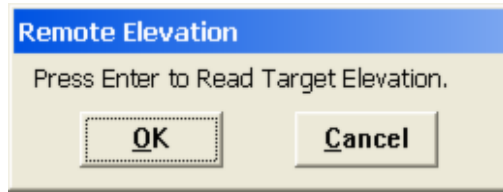

Back in the REM ELEV screen, your angle, zenith, and distance are shown, along with the remote height and remote elevation.

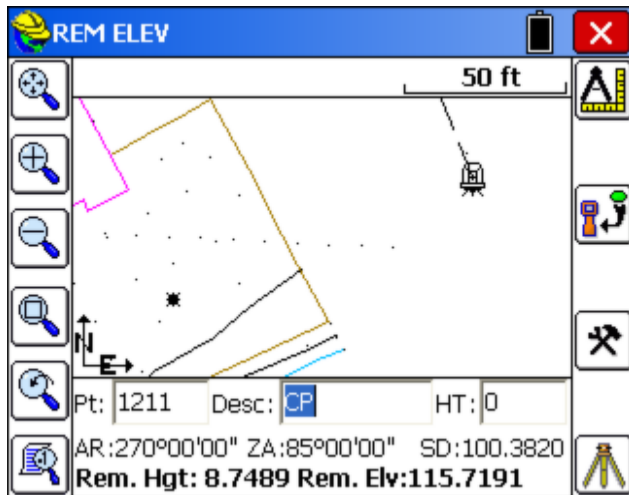

- **Read Icon:** This allows the user to take additional shots above or below the previously defined base point. Pressing the **Enter** key will also repeat this command.
- **Store Icon:** This button stores the current target offset point to the job file
- **Configure Icon:** This takes you to the **Configure** settings also found on the EQUIP tab.
- **Instrument Icon:** This takes you to the standard **Instrument Setup** dialog.

Log Raw GPS

This command allows you to log static data to the receiver or a data card (depending on instrument type) for use with post processing software.

Post Processing (Logging Static Data) for NovAtel/Sokkia Radian/Sokkia Radian IS

Go to the SURVEY tab, and select the **Log Static Data** button. You will see a screen with three buttons (see the figure below), or an error message stating that the data collector could not connect to the receiver. If you receive an error message, check connections and the data card.

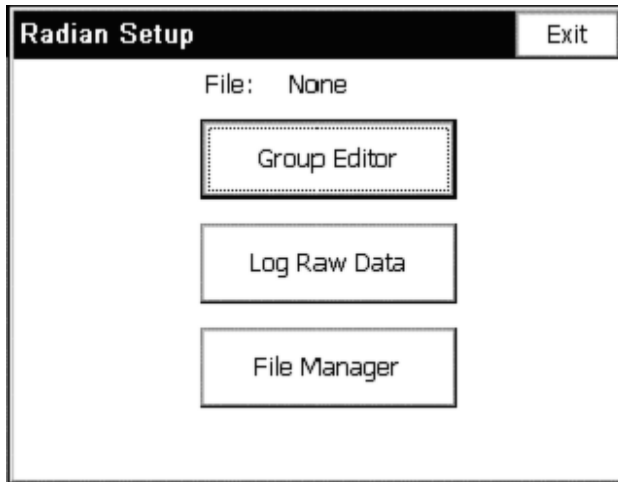

If you want to change the groups you already have on the device, select **Group Editor**. It will take up to five seconds for a dialog with group information to appear. This dialog box will be covered later, as it is only necessary for post processing if you have no groups.

Tap on the **Log Raw Data** button to start logging raw data. From this point, you can choose the **File Manager** button to see what files are on the receiver's card. You can delete files here if memory is low. More information on the **File Manager** dialog will be covered later.

The **Log Raw Data** dialog contains a list of groups (or a message that no groups were found), three buttons, and a place to enter a file name. In order to continue, select a group, enter a file name, and tap **Use Selected Group For File**. If you have no groups (or wish to see/change the groups you already have) you will need to click **Edit Groups**, and add a group, as shown below.

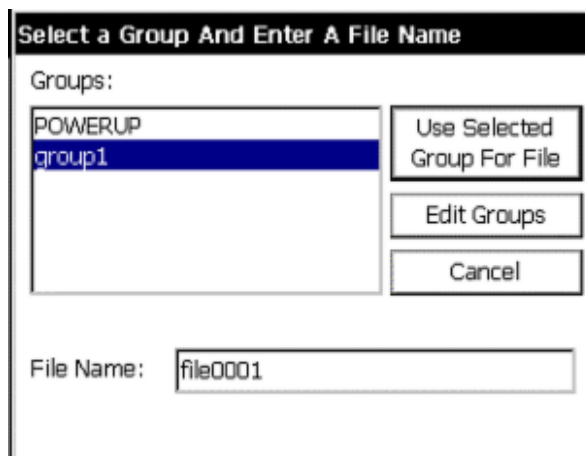

Next is the **Tagging Site** dialog. To start tagging a site, enter the information requested including site name, site code, and antenna height (changing is optional--see *Changing the Antenna*). You will also decide here whether you want the site to stop automatically after a duration of your choice, or when **End Site** is selected. Tap **Start Site**, and all the information entered will be grayed out until the site is ended. Stop the site at any time by clicking **End Site**. Before ending the site, you will have the option to change the antenna information (in case you made a mistake). View the satellite status at any time using the **View Status** button. This will not affect the tagging of the site.

You can tag as many sites as you wish. When you are done, click the **Exit** button. SurvCE will ask you if you want to continue logging the file. If you do, click **Yes**, and the next time you select **Log Raw Data**, you will go directly to the dialog box shown above. The file name will appear in the main post process screen if it is being logged. If you wish to leave the receiver logging, you can exit the setup, and the next time you come back to post processing, the software will know you are still logging a file.

File Manager

Under the SURVEY tab of the main menu, select the **Log Static Data** button. You will either see a screen with three buttons, or an error message stating that the data collector could not connect to the receiver. If you receive an error message, check connections and the data card. Click on the **File Manager** button to see what files are on the receiver's card. In this dialog, you see a list of files, along with their respective sizes.

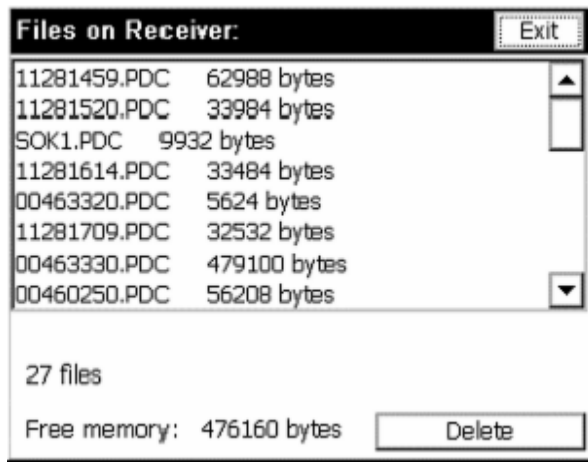

At the bottom of the dialog, the free memory is shown, along with a cancel and a delete button. If you are running low on memory, you can delete files here. To delete a file, click on the file from the list and then tap the **delete** button. You will be asked to verify that you want to delete the file. To exit this dialog, click **Exit**.

Group Editor

Go to the **SURVEY** tab, and select the **Log Static Data** button. You will see a screen with three buttons, or an error message stating that the data collector could not connect to the receiver. If you receive an error message, check connections and the data card.

If you want to change the groups you already have on the device, choose **Group Editor**. It will take up to five seconds for a dialog to appear with group information.

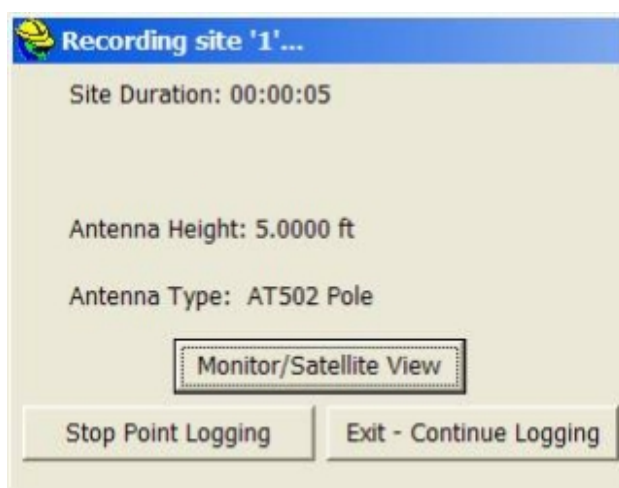

If the Group Name is “NewGroup,” there are currently no groups on the receiver.

To add one, fill out the information and click the **Save** button. If there are already groups you may add a new one by selecting **New**, filling in the required information, and hitting **Save**.

To see other groups, click **Prev** or **Next**. To delete a group, click on the **Del** button.

To edit a group, make any changes, and click the **Save** button. If a group name is modified, it may take slightly longer to make the change. In order to change the antenna, click the **Change Antenna** button (see *Changing the Antenna*).

When you are satisfied with the groups, click **Close**. You will be asked if you wish to start logging data. If you click yes, you will enter the **Log Raw Data** dialogs.

Post Processing (Logging Static Data) for Topcon

Go to the Survey Menu, and select the **Log Static Data** button. You will see a screen with four buttons.



If you want to manage the files (to see how much memory they are using and to delete files) on the receiver, click the **File Manager** button. If a file is open, you can now tag sites. Otherwise, open a file by clicking the **Start File** button.

The file name can be chosen from a list of existing file names using the suggested file name, or a file name of your choice. The antenna height and antenna type can be changed using the **Change Antenna** button (see *Changing the Antenna*). The interval can be selected from the list, or you can enter your own, in seconds.

Start New File

File Name: New 8N40318A

Existing log0712d

Elevation Mask: 10

Antenna Height: 0.000000

Antenna Type: Manual

Interval: 15.0 seconds

After starting a file, you will be returned to the main screen. From here you can leave the file recording, manage files, exit, or start tagging sites. To tag a site, click the **Tag Site** button.

Tag New Site

Free Mem on Receiver : 24102792 bytes

File: 8N40318B

Site Name: site

Antenna Type: RegAnt

Antenna Height: 2.000000

Interval (in Seconds) 15

Stop Logging:

Manually After 1 minutes

The **Tag New Site** dialog shows the available space on the receiver, and gives you the ability to enter a site name, change the interval, and change the antenna. You can choose to have SurvCE stop logging the site automatically after a specified time period, or stop it manually. Even if you choose to stop logging automatically, you will still have the option to stop it manually using the **Stop Point Logging** button.

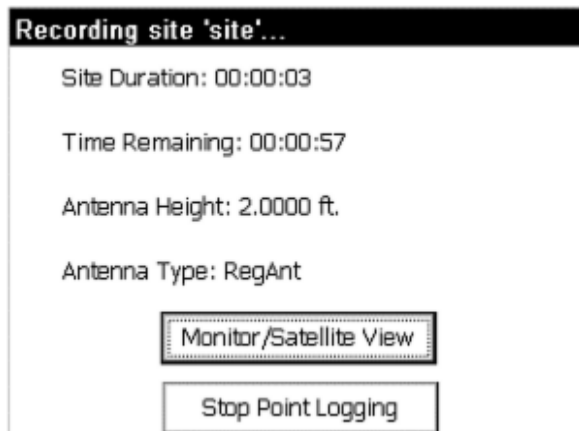

After you exit this screen (automatically or manually), you will be returned to the main post processing screen. From here, you may tag more sites, close the file, or manage your files.

When you are ready to close the file, hit the **Close File** button.

Post Processing (Logging Static Data) for Leica System 500 GPS Setting Up Post Processing as a Base

In order to do post processing as a base, you must start when you configure the base. From the EQUIP tab select **Configure Base** and enable the **Log Static Data to PC Card** check box.

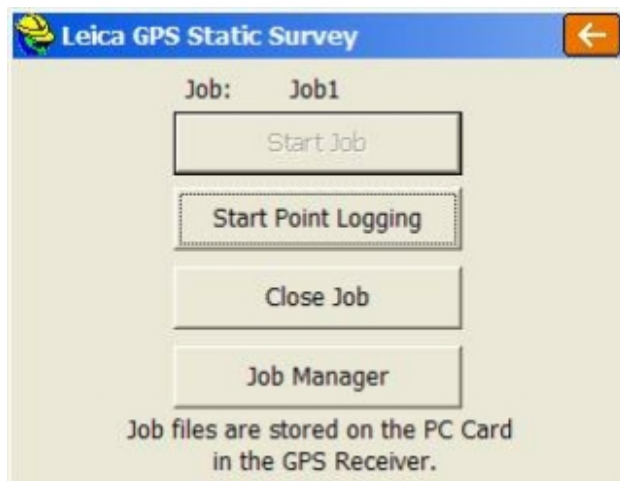

Start New Job ✓ ✕

Job Name: New
 Existing

Elevation Mask:

Antenna Height: 5.0000 ft

Antenna Type: AT502 Pole

Interval:

Tag New Site ✓ ✕

Free Mem on PC Card: 3688 kBytes

Job1

Point ID: Antenna Type: AT502 Pole

Antenna Height: 5.0000 ft

Interval: 0.5000 second

Stop Logging:
 Manually After minutes

Proceed through the **Configure Base** screens as normal until reaching a dialog asking for a job name and interval. After entering these, the job will start recording. To end the job, turn off the receiver. Your next job should start up without complication.

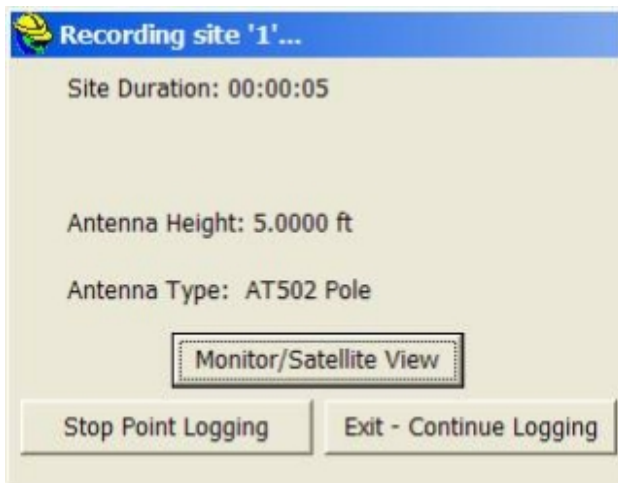
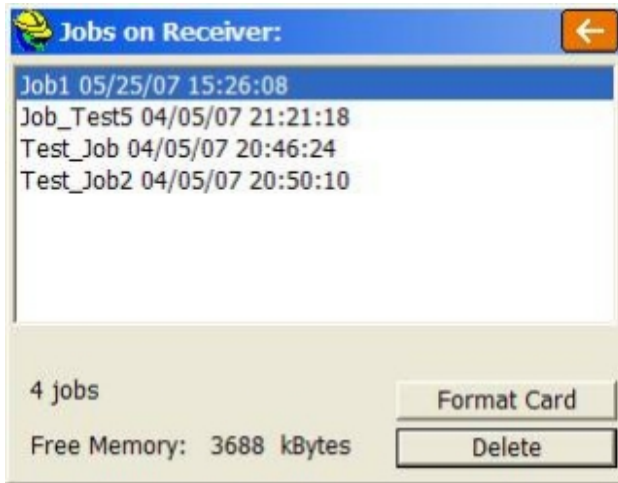

Setting Up Post Processing as a Rover

From the SURVEY tab choose **Log Static Data**. The data collector will check to see that the receiver is connected and has satellites (if the receiver doesn't have satellites, no post processing is possible). If successful, a screen with four buttons will appear.



To manage jobs, click the **Job Manager** button (more information on this feature will be covered later in the documentation). To start a post processing job, click the **Start Job** button. Select a job name from the existing jobs, or create a new one. To change the antenna settings, click the **Change Antenna** button.

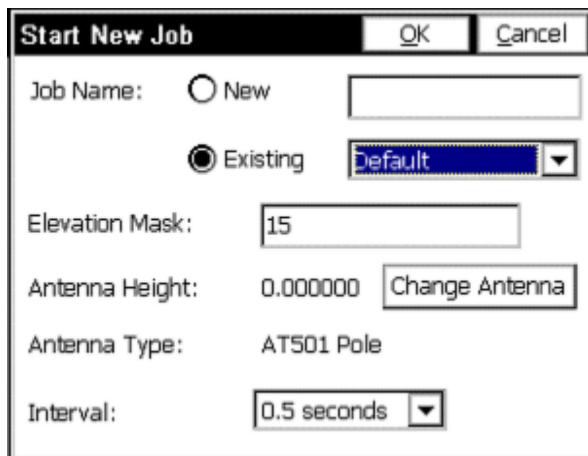

After starting a job, you will return to the Post Processing menu. Now, you will be able to log points, close the job, or manage jobs.

To start logging a point, click the **Start Point Logging** button. The current job, the available memory, the interval, and the antenna height (which can be changed by clicking the **Change Antenna** button) are shown. Here you will need to enter a site name and choose whether to stop logging the point automatically or manually.

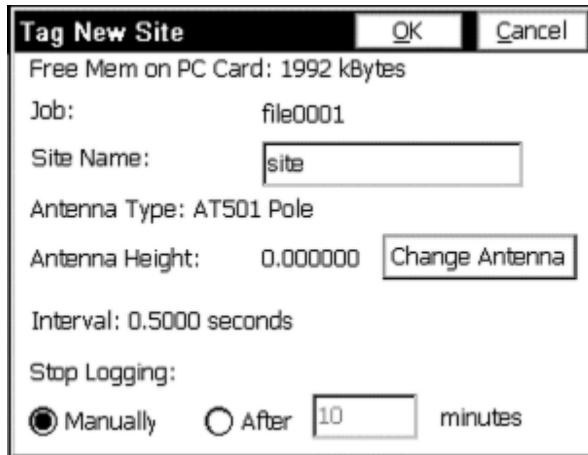

The dialog below will appear to show information about the point being logged. It can be exited without stopping the point.

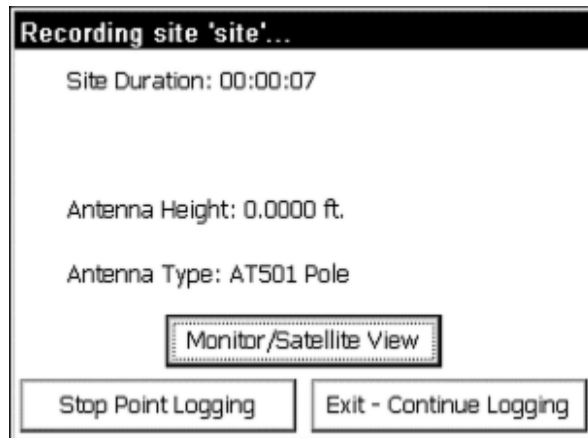

After exiting the screen, you will return to the menu. You can choose to end the job, log more points, or just leave it running while you do other things. To end the job, click the **Close Job** button.

File Manager

Go to the SURVEY tab again and click the **Log Static Data** button. Again, you will see a screen with four buttons. This time, click on the **File Manager** button to see what files are on the receiver's card. In the dialog box, you see a list of files along with their respective sizes.

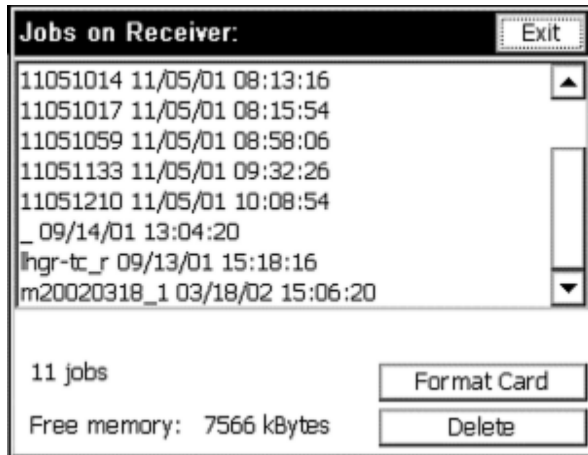

At the bottom of the dialog, free memory is shown, along with a **Delete** button. If you are running low on memory, you can delete files using this dialog box. To delete a file, click on the file from the list and select the **Delete** button. You will then be asked to confirm that you wish to delete the file. You can also format the card here using the **Format Card** button. This will destroy all the data on the card! Make sure you don't need any of the data on the card before formatting it. To exit this dialog, choose **Exit**.

Changing the Antenna for Post Processing

Clicking on **Change Antenna** from various SurvCE Post Processing dialogs leads you to this dialog. Here you can change the antenna height by choosing either Vertical Height or Slant Height.

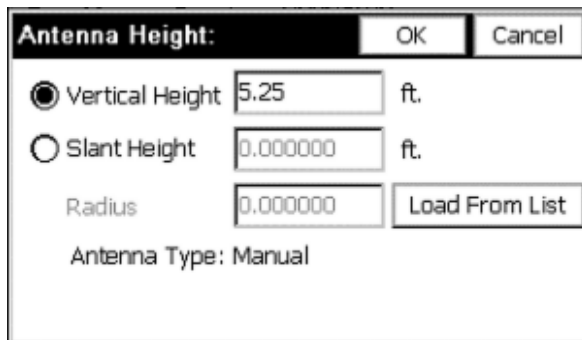

For Vertical Height, click on the radio button for Vertical Height, enter a height, and choose **OK**. For Slant Height, click on the radio button for Slant Height and enter the slant height. Then, click on **Load From List**. Choose the antenna and click **OK**. The radius should be filled in for the antenna. If your antenna is not listed, choose **Manual**, click **OK**, and enter the radius in the edit box on the main **Antenna Height** dialog.

When you are finished, click **OK**. The program will calculate an antenna height if

you chose slant height. Antenna height is displayed in the original dialog.

Post Processing (Logging Static Data) for Thales/Ashtech in SurvCE

There are two methods to log static data with a Thales/Ashtech receiver. The first is from the **Log Static Data** button under the SURVEY tab of the main menu. The second is using Configure Rover and Configure Base, as described below.

Logging Static Data from the Survey Menu

Go to the SURVEY tab, and select the **Log Static Data** button. The result is a dialog with six buttons, or an error message stating that the data collector could not connect to the receiver. (If you receive the error message, check connections on the data card.) From here, one can start a file, leave the file recording (exit), manage files, pause recording (stop processing), resume recording (start processing), or start tagging sites. To manage files, see below. If a file is open, but paused, you can choose to resume it here.



If a file is open, you can now tag sites. Otherwise, open a file by clicking the **Start File** button. The receiver chooses the file name based on the names of the last site in the file. The antenna height and type can be changed via the **Change Antenna** button (see *Changing the Antenna*). The interval can be selected from the list, or you can enter your own, in seconds, using the edit field.

Start New File

Elevation Mask:

Antenna Height: 5.000000

Interval:

After starting a file, the software returns to the main screen. From there, you can leave the file recording (exit), manage files, or start tagging sites. To tag a site, click the **Tag Site** button.

Tag New Site

Free Mem on PC Card: 27493 kBytes

Site Name: Site Attr.:

Antenna Height: 13.0000 ft.

Interval (in Seconds)

Stop Logging:

Manually After minutes

The **Tag New Site** dialog shows the available space on the receiver, and allows you to enter the site name (which must be four characters) and site attribute. You may also change the interval and the antenna height here. You can choose to have SurvCE stop logging the site automatically after a specified time period, or manually. If you choose to stop the logging automatically, you will still have the ability to stop it manually using the **Stop Point Logging** button.

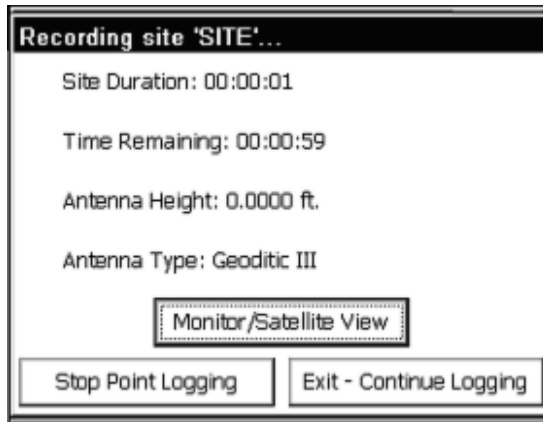

The **Recording Site** screen can be exited by clicking the **Stop Point Logging** button or the **Exit-Continue Logging** button (which leaves the site running but exits the dialog). You will return to the main post processing screen. From here you may exit, tag more sites, manage files, or close the file by clicking the **Close File** button.

Start Processing/Stop Processing

These buttons pause and resume recording to the file. If the file is recording, **Stop Processing** will pause the recording. If the file is not recording, **Start Processing** will resume the file. When the file first starts, it is recording.

File Manager

Go to the SURVEY tab, and click the **Log Static Data** button. You will see a screen with six buttons, or an error message stating that the data collector could not connect to the receiver. If there is an error message, check connections on the data card.

Click on the **File Manager** button to see what files are on the receiver's card. The next screen contains a list of files and their respective sizes.

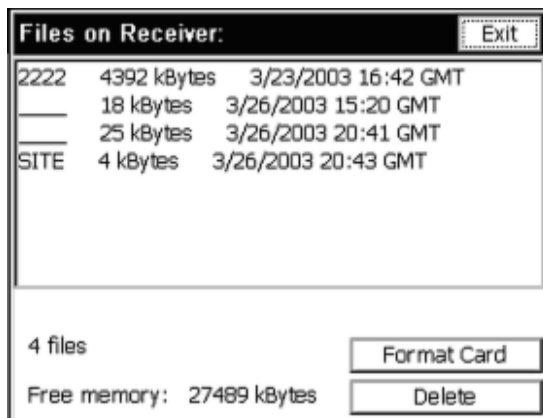

At the bottom of the dialog, free memory is shown, along with a **Delete** button. If you are running low on memory, you can delete files using this dialog box. To delete a file, click on the file from the list and select the **Delete** button. You will then be asked to confirm that you wish to delete the file. You can also format the card here using the **Format Card** button. This will destroy all the data on the card! Make sure you don't need any of the data on the card before formatting it. To exit this dialog, choose **Exit**.

Thales/Ashtech File Types & Logging Static for RTK Points

The Thales/Ashtech receivers log data into various files on the receiver during Log Static Data. These files are all contained in a U-file, which is what the **File Manager** will list from the PC Card. When these files are decompressed on the computer intended to do post processing (using the Ashtech Download program), they are split into the following files: an almanac file, a **B-file** (raw data), a **D-file** (description and antenna information), an **E-file** (ephemeris data), and an **S-file** (session information). D-files are created automatically from the antenna and site information.

SurvCE creates **O-files** automatically on the data collector from receiver information. The O-file is named the same as the coordinate file name, with an .obn extension, and placed in the data directory. This file is needed for GNSS Studio, as it contains vector information. However, this information can only be added if the point stored has a GPS fixed position.

To store an RTK point into the O-file, go into Store Points with the GPS position fixed. Enter information for point (site id), description (site attribute), and antenna height, and click the **Average** button to store an OBEN average. For every reading taken by GPS Average, an OBEN measurement will be taken to be averaged into the final measurement. The final measurement is stored in the crd file and the O-file on the data collector, as well as the static data files on the receiver.



Remember, the file must be recording in order to log static data from Store Points. If a point is stored, and no site is logged, to log one, go to the **Log Static Data** Menu, select **Start Processing**, and return to **Store Points**. It is now possible to

log a point from Store Points.

Note: In one reported instance, a damaged PC card caused the equipment to display a “Card Full” message. Use the **File Manager** within **Log Static Data** to review data on the PCMCIA card in the receiver and use File Manager to re-format the PCMCIA card on the receiver if the card appears to be causing errors. Be sure to copy any useful information from the PC card before re-formatting, or install a new PC card.

Logging Static Data with Navcom Receiver

The Navcom Receiver supports logging of static data to a file. The files generated with this option can be post-processed to increase the accuracy of your Survey using software produced by third parties such as Way Point. SurvCE allows you to turn Navcom static data logging on and off, and manipulate files on the receiver, but you will still need third party software to post-process the resulting files. To begin logging static data, go to the SURVEY tab and click the **Log Static Data** Button. If an error message appears, stating that the data collector could not connect to the receiver, check connections and the data card. You have three choices on the setup screen.

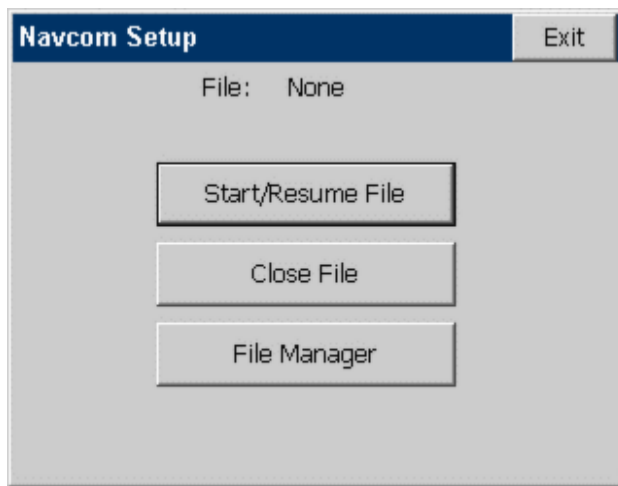

- **Start/Resume File:** To start a new file on the receiver or to append to an existing file, select **Start/Resume File**. In the next menu, type the name of the new file, or select the name of an existing file from the drop list, and press **OK**.
- **Close File:** Select this to close a file that is open for logging.
- **File Manager:** To manipulate files on the receiver, choose this button.

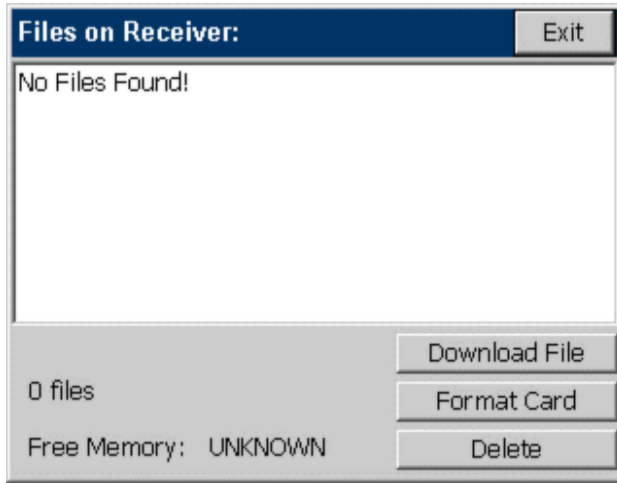

All of the files on the receiver, along with their sizes and creation dates, are displayed in the list. Also, the total memory used is displayed in the lower left corner of the dialog. To delete a file, select the file and press **Delete**. To download a file to your data collector, select the file and press **Download File**. To format the MMC data card on your receiver, press format card. Formatting the card will erase all existing data.

COGO

This chapter provides information on using the commands from the COGO menu.

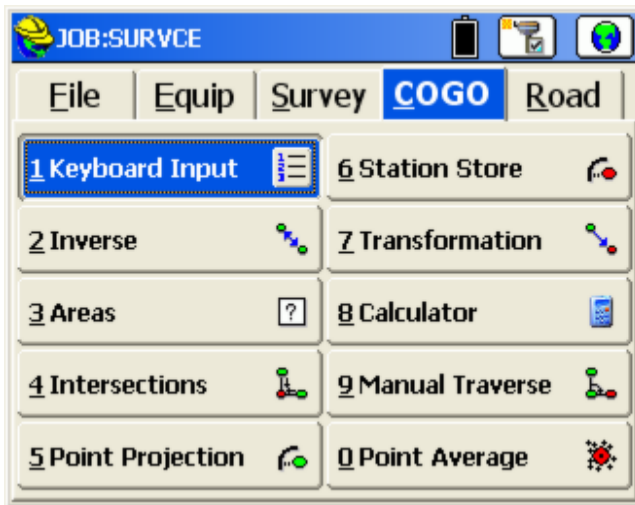

Keyboard Input

This feature allows you to manually enter or edit coordinates in the current job file or the current control file. The option to edit points in the control file only appears if **Use Control File** is enabled in Job Settings. There are fields for Point ID, Northing, Easting, Elevation and Description. If adding a point to an existing job, SurvCE displays a point ID one greater than the highest in the file. If starting with a new job, the point ID will default to 1.

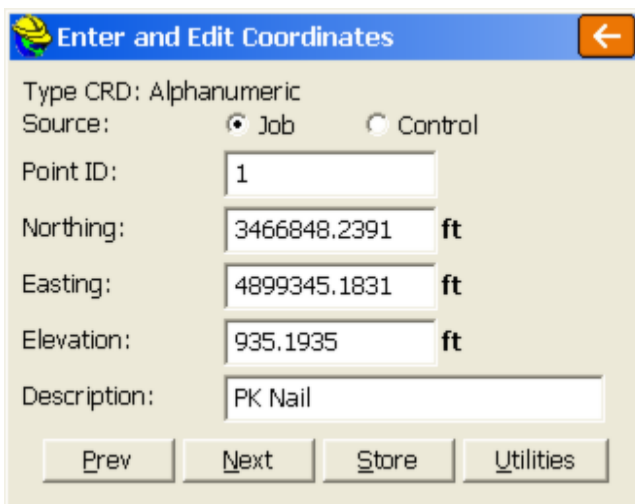

- **Previous and Next:** These buttons move back and forth through the coordinate file, skipping points with zero coordinates. The **Next** button will not store the current data to the file.
- **Store:** This writes the entered data to the file and advances the display to the next point. If you are editing an existing point, when you press **Store**, SurvCE will warn you that the point number has already been used. You then have a choice to overwrite this point number or use a new number.

If you want to create a duplicate point, simply change the point number and press **Enter** or **Store** to save it.

If you a duplicate point with a different elevation, change the point ID and elevation and press **Enter** or **Store** to save it.

- **Utilities:** The Utilities button allows the user to modify or delete a point or range of points. The Utilities screen appears below:

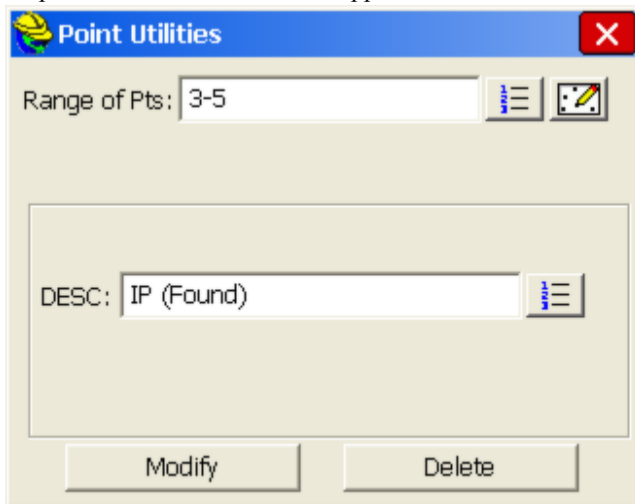

There are two uses of the command: to Delete a point or range of points, and to Modify the descriptions of a point or range of points. For example, if you wished to assign the description "IP (Found)" to points 3 through 5, you can enter the point range and description as above, and then tap "Modify". You will have a confirming screen as shown below:

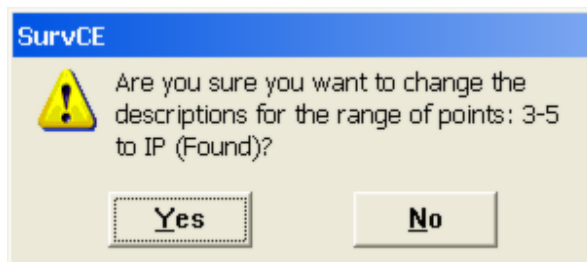

Inverse

This command reports the bearing and horizontal distance between any two user-specified points that are contained within the current job. If under **Units** in **Job Settings**, Angle is set to Azimuth, then inverse will display azimuths instead of bearings. You can override the display settings in **Job Settings** by choosing between Bearing (Brg N,E or Brg E,N), North Azimuth (NAz N,E, NAz E,N) and South Azimuth (SAz N,E or SAz E,N) at the bottom right of the Inverse screen.

Inverse can be run in either 2D or 3D mode as selected at the top of the screen. In 2D mode, the program displays only the bearing and distance between the two points. As many as four inverses can be viewed at once, as shown below.

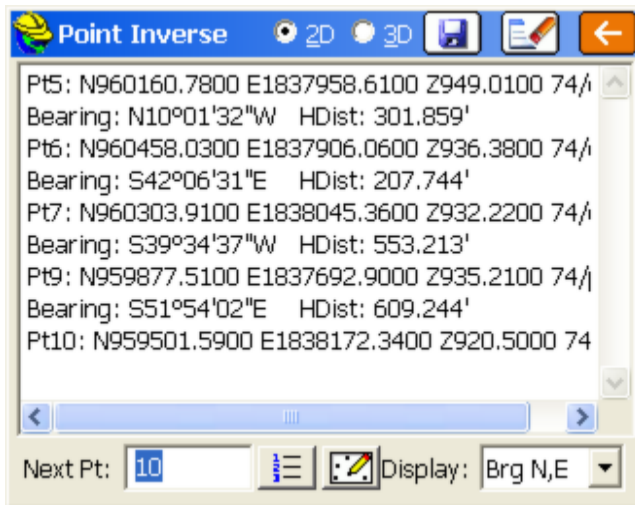

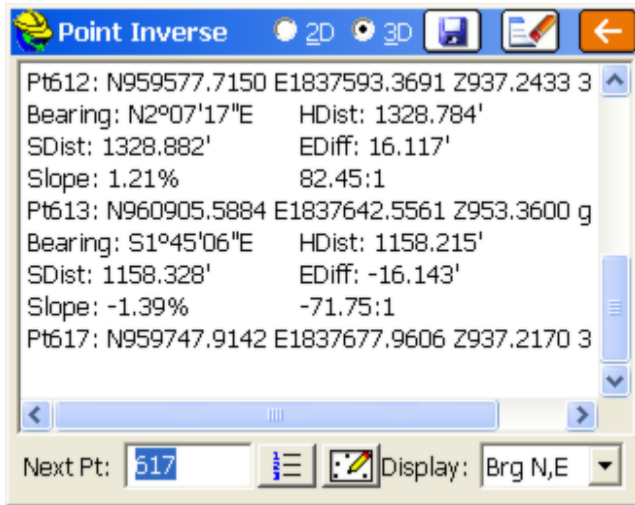

In 3D mode, the report also displays the slope distance, elevation difference, slope in percent, and slope as a ratio, between each point. The Northing, Easting, Elevation and description of the specified points are also shown.



To run the inverse routine, enter the first point number at the bottom (you may also select from a point list or select from the map screen). Press **Enter**, and then enter the second point and press **Enter** again.

If a control file is specified in **Job Settings**, then when you run inverse, you can choose the **List** icon at the bottom center of the screen and then select points from the control file. In this way, you can inverse between points in your current file and your control file as needed.

If under **Units** in **Job Settings**, Angle Unit is set to Grads/Gons, then the Inverse command will default to the 400 circle and will display North azimuths.

-  **Clear Command:** Use this icon to clear the results window.
-  **Save Command:** Saves any inverse to a TXT file, and will auto-append data if the the same TXT file is used.

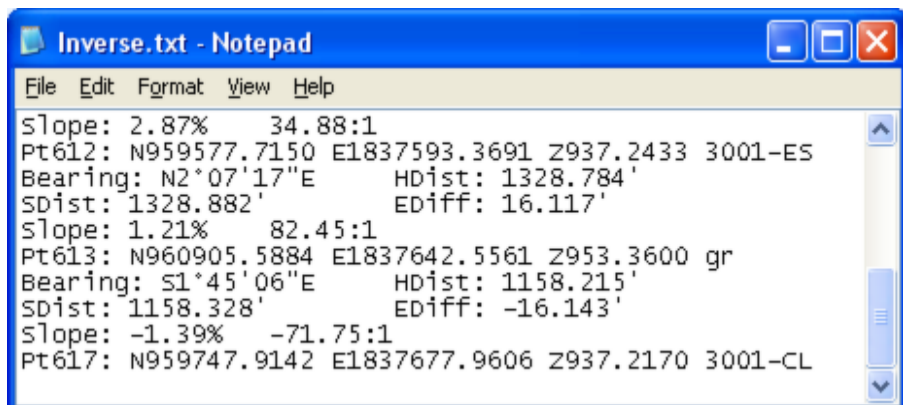

Areas

This command calculates the area of a closed figure that is defined internally by user-entered point numbers contained within the current job, or by a polyline picked from the screen. The polyline method allows selection of figures with arcs.

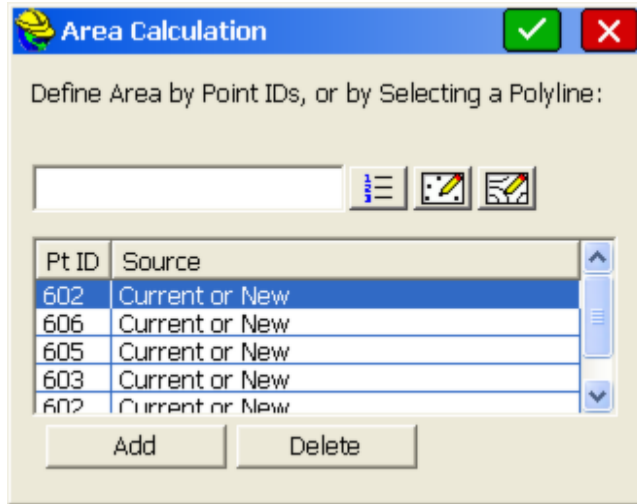

You may specify individual point numbers or type in a range of point numbers to define the area. Individual point numbers can be entered as 602,606,605,603,602 or each number followed by Enter. After clicking OK (green checkmark), the area is reported at the bottom of the map screen. A temporary polyline is also drawn between the points. Results are reported in square feet and acres when units are set to feet, and square meters when units are set to metric.

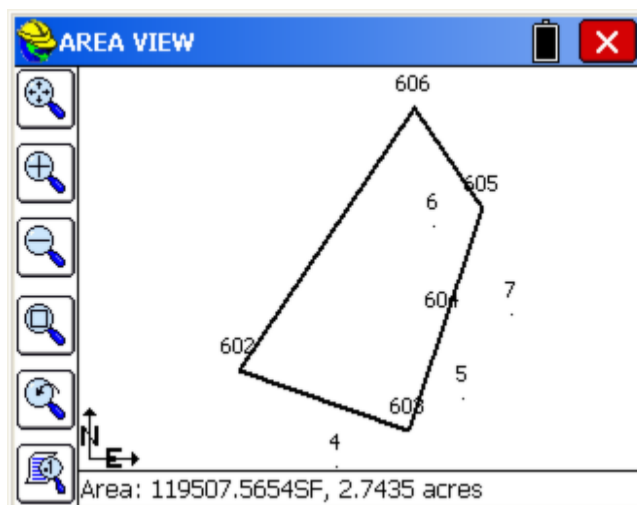



If the polyline method is used to solve the area, the program will bring up the **MAP** screen where you pick a polyline. Since the area can be written to a raw file (see below), you can use the direction icon in the lower right of the screen to confirm or change the direction that the polyline is drawn.

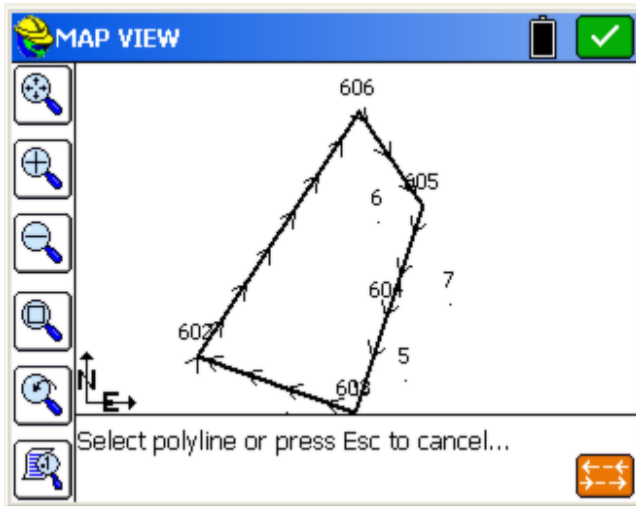

When you are certain that you have selected the desired polyline, press **OK**, and the graphic screen presents the area. Since the point-defined area is a straight point inverse, the advantage of the pick polyline approach is that the polyline may contain arcs.

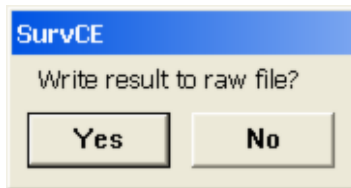

At the end of each area calculation, you are asked if you would like to “Write result to raw file?” This will write a line in the raw file as "Calculate area of polyline 602,606,605,603,602: Area = 119507.5654SF, 2.7435 acres." For point-defined figures in metric, the raw file record presents square meters.

Intersections

This command allows for the calculation and storing of points based upon standard surveying practices of Bearing-Bearing, Bearing-Distance, or Distance-Distance Intersection calculations. Data can be entered manually or defined by selecting points from a point list or map. The kind of intersection calculation to be performed determines the number of possible solutions. With a Bearing-Bearing calculation, there will be only one possible solution. Bearing-Distance, and Distance-Distance calculations will have two possible

solutions prompting the user to pick the desired solution. Note that in intersection calculations of Bearing-Distance and Distance-Distance there may be no solution for the input data. In these cases, Carlson SurvCE will display the message, "No Valid Solution."

The screenshot shows a software dialog box titled "Intersection". The title bar includes a yellow icon, the text "Intersection", and three buttons: a pencil icon, a green checkmark, and a red X. The dialog is organized into two main sections: "First Point" and "Second Point". Each section contains a "Point ID" field with a list icon and a map icon, an "Azimuth" field, a "Distance" field with a unit "ft" and an "Off:" field, and a "Use Points" button.

From the COGO Menu, select **Intersections**. Fill out the appropriate data fields to perform the desired calculation. The **Enter** key moves forward through the edit boxes. The current Angle setting in **Job Settings, Units**, dictates whether angles are prompted as azimuth or bearings.

- **Off:** Use these edit controls to create intersections that are defined by parallel offsets to the defined or computed direction.

All Intersect routines create SP records in the raw file, storing the calculated coordinates for each new point. This SP record is identical to records created by keyboard input.

Bearing-Bearing

This method locates a point at the intersection of two lines. Select Point 1 by entering the desired point number, or pressing the **Point List** icon and selecting the desired point. Pressing the **Map** icon will allow for selection of the desired point directly from the screen. Note that when selecting a point from the screen, if the desired point cannot be determined from the picked point on the screen, a listing of the nearest points to the desired location will appear allowing for verification of the targeted point. If the list appears, select the desired point from the list by clicking on it.

Define the bearing from the first point by typing in the bearing or by specifying two point IDs. Repeat the procedures for defining the bearing from the second point.

Bearings can be entered in three forms:

- SE40.5945 becomes S40d59'45"E
- S40.5945E becomes S40d59'45"E
- 240.5945 becomes S40d59'45"E

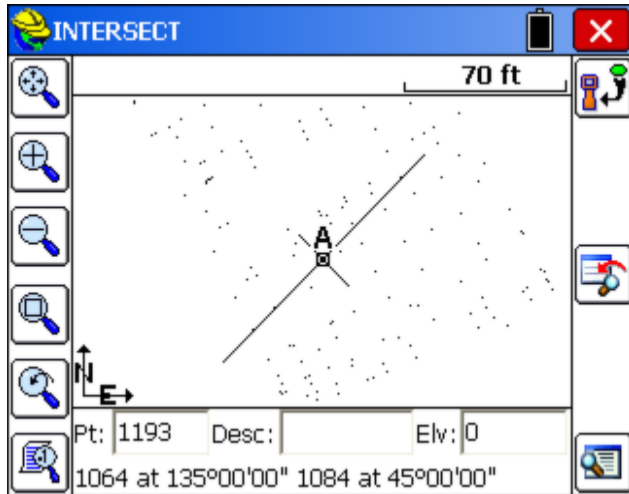

Once data entry is complete, press the **OK** button. The calculated point will appear on the screen with the input data detailed at the bottom of the screen. Store, Modify (review and revise) and RESULTS Options are located on the right side of the **Map** screen.

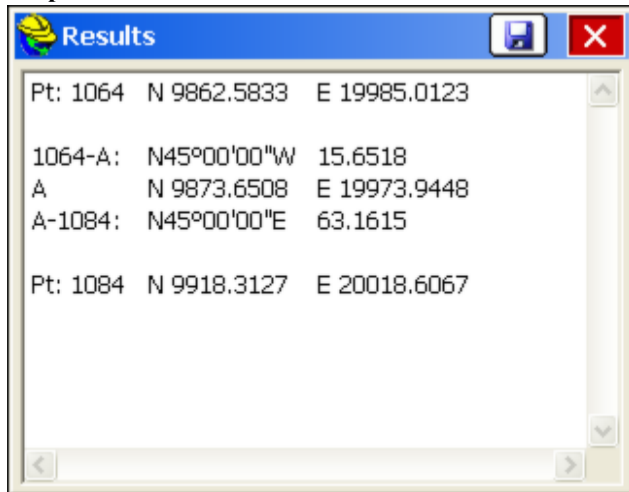

-  **Save:** Use this icon to save a report of the inverse.

The results screen will display the coordinates of the base points, the inverse bearing, the distance from the base points to the calculated INT1 point (and INT2

for distance intersections), and the coordinate data for the calculated points. Note that calculated points are labeled as Int1 and Int2 until the points are stored. These Option Buttons are present on all **Map** screens displayed while in the Intersections routine. Once **Store** is selected or the **Enter** key pressed, the stored point will inherit the specified point number, description, and the elevation displayed at the bottom of the screen (optional). There can be only one solution for a bearing-bearing intersection.

All Intersect routines handle the 400 circle, if configured to grads/gons within **Job Settings, Units**.

Bearing-Distance

Define the Bearing from the first point, then define the known horizontal distance from the second point.

The screenshot shows a dialog box titled "Intersection" with a blue header bar containing a yellow and green icon, a pencil icon, a green checkmark, and a red X. The dialog is divided into two sections: "First Point" and "Second Point".

First Point:

- Point ID: (with a list icon and a pencil icon)
- Azimuth: (with a "Use Points" button)
- Distance: ft Off:

Second Point:

- Point ID: (with a list icon and a pencil icon)
- Azimuth: (with a "Use Points" button)
- Distance: ft Off:

Select **OK** and the map screen will appear showing a circle radiating from the distance base point and a line from the bearing base point, defined by the entered bearing. The line is extended to intersect the circle at the two possible solutions.

Pressing **Enter** or **Store** will display the prompt "Pick a Solution". To select the point, simply pick it from the screen. Picking near the desired solution is sufficient. The program will select the nearest solution position. Pressing **Enter** again will accept the second possible solution for the intersection.

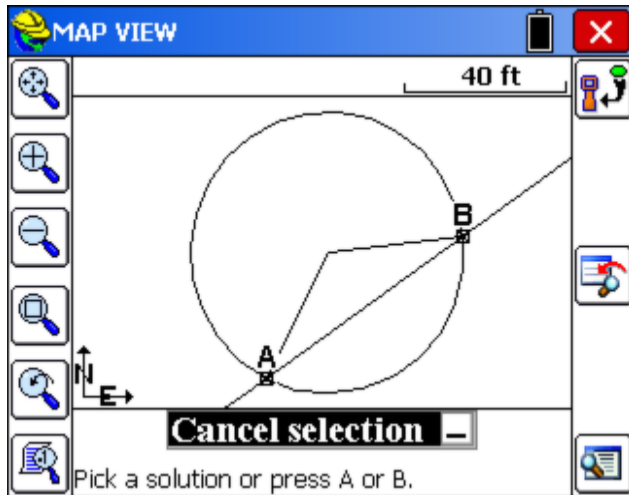

Distance-Distance

Enter the known horizontal distances from both points.

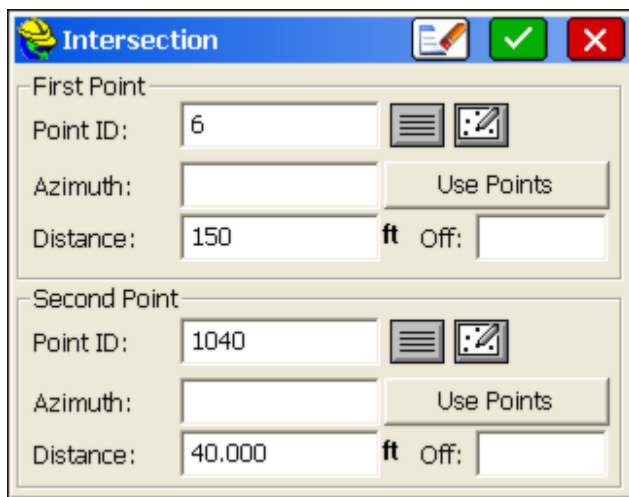

Select **OK**, and the map screen will display showing circles radiating from the first and second selected base points. Lines leading from both base points to the two possible intersections of the circles are also shown.

Pressing **Enter** or **Store** will display the prompt "Pick a Solution". Select the desired calculated solution. To select the point, simply pick it from the screen. Picking near the desired solution is sufficient. The program will select the nearest solution position. Pressing **Enter** again will accept the second possible solution for the intersection. If there was no solution for the input data, SurvCE will display "No Valid Solution".

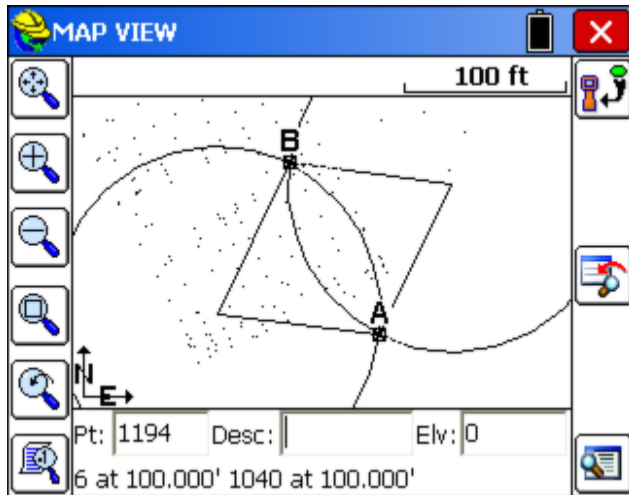

Point Projection

This command allows you to calculate the station and offset of any entered or surveyed point relative to a known centerline or baseline. Note that the Station Store command will calculate a point at a given station and offset. Point Projection does just the reverse — it calculates a station and offset for any given point. It also will calculate the “Intersect”, or the projection of that offset point on the baseline. This baseline “intersect”, or perpendicular projection point, can be staked out and stored. The application of the routine is shown below.

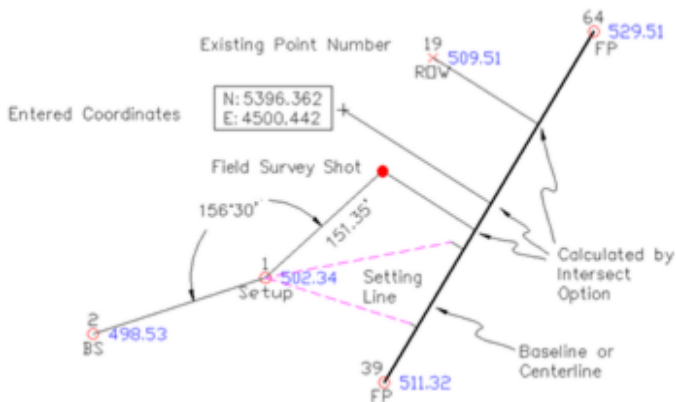

The coordinates from which to project can be entered in three ways:

- By point number
- By entering the coordinate values
- By taking a GPS or total station reading

The station, offset, and vertical difference of the point is then calculated, and the **Intersect** button (see the above figure) will calculate the projected perpendicular intersect point on the baseline. This Intersect can also be staked out using the Stake button.

You must first define the baseline. You can define the baseline by one of the following methods:

- **Define Line:** Select two points to define the line.
- **Define Alignment:** Select a predefined centerline file (.cl file), graphically pick a polyline or enter a sequence of points.
- **Define Arc (3 Points):** Select three points on the arc.
- **Define Arc (PC, PT, Value):** Select the start and end points of the arc and enter the radius length.

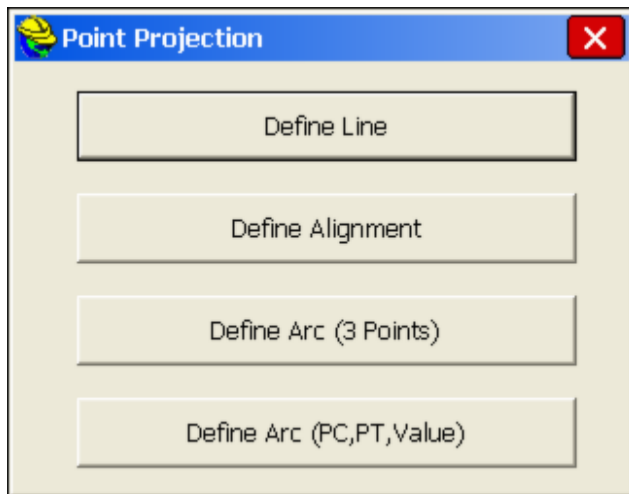

If you choose two points, you must then define the line in the **Point Projection** dialog box as shown below.

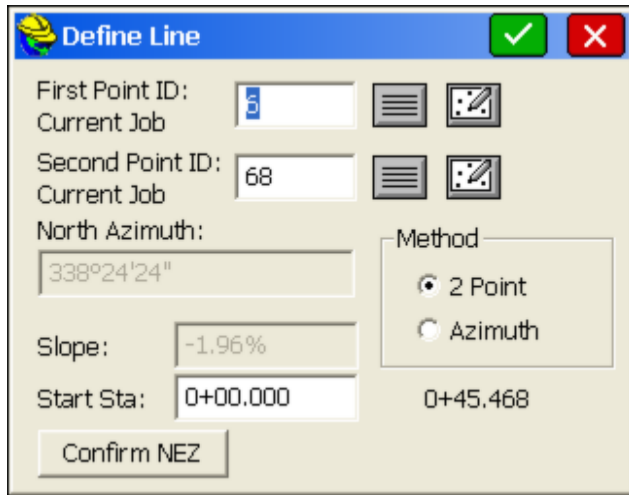

With the two points method, you simply enter two point numbers, or choose them from the point list or MAP. The azimuth and slope between the two points is calculated, along with the ending station, based on the entered start station. With the Azimuth method, you define the line by entering a first point and then entering an azimuth and slope. You can confirm the coordinate values of the points by choosing **Confirm NEZ**. When the line is defined, choose **Continue**. You must now define, or designate, the point that is offset from the line in the **Point Definition** dialog.

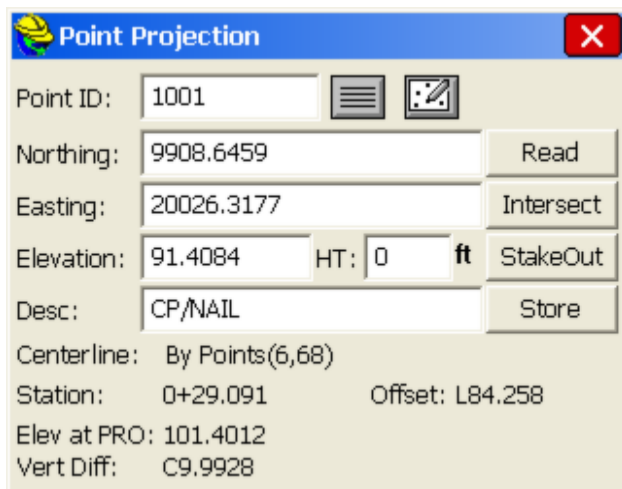

You can enter a point ID, select one from the list, or select one from the map. You can also enter coordinates to define a new point, or read values from the instrument. As soon as enough information is entered, the station, offset and vertical difference is displayed or the message "OFF CENTERLINE" is displayed. This message lets you know that a station/offset cannot be computed for the coordinates entered.

- **Read:** This command reads the instrument to gather coordinates for point projection.
- **Intersect:** This command will project the coordinates entered perpendicular, back to the centerline and enter these new coordinates into the **Point Projection** dialog. From there you can store or stakeout the intersect points.
- **Stake:** This command will allow you to stakeout the displayed coordinates (typically used to stakeout the intersect points).
- **Store:** Pressing **Store** after **Read** stores the offset coordinate. Store after **Intersect** is selected stores the coordinates for the intersect point on the centerline (perpendicular from the offset point). Store after entering coordinates or a point number for the offset point, without selecting Intersect, will simply store the offset point coordinates again as a new point number. Store is most often used to save the calculated intersect points to the coordinate file. Pressing Store will save an SP (store point) record in the raw file, and a note record will indicate that the point was calculated within Point Projection.
- **Computing Ranges of Point Offsets with Special Report:** A range of points can be entered leading to reporting of all stations and offsets to a selected horizontal alignment (centerline). In the example below, a centerline has 7 points shown at offset.

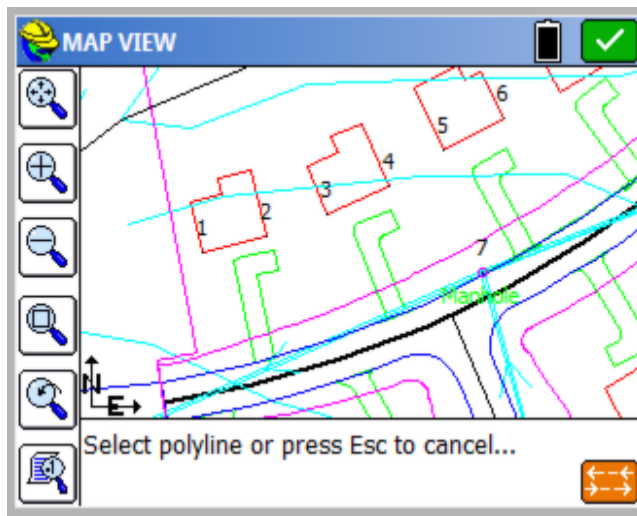

If point 1 is entered, you get the normal station and offset report. And if point 1 has an elevation, and "Use Vertical Alignment" is clicked on when selecting the alignments, you will get a cut and fill as shown:

Point Projection

Point ID: 1

Northing: 3337.2459 Read

Easting: 4398.4759 Intersect

Elevation: 841.839 HT: 6.610 m Stake

Desc: Store

Centerline: 2D Polyline
 Station: 0+41.304 Offset: L82.275
 Elev at PRO: 840.1080
 Vert Diff: C1.731

When entering a range of points, use normal range conventions (eg. 1-6, or 1-7,10,14-16). You can present the range appearance by clicking the Settings icon at the top of the screen, just left of the back arrow. You can compare Survey to Design where if the field point is 841 and the profile vertical alignment is 840, it would be a Cut 1, or you can compare Design to Survey in which case that would be a Fill 1. Comparing Survey to Design is normal operation.

Settings

Include Header

Include Station, Offset, Elevation

Include Cut/Fill Survey->Design

Include Point ID

Round Station to the Nearest 5

Offset Prefix: Left: L Right: R

Then click the report button to see the results for points 1 to 7, as output to a TXT file and viewed in Notepad.

#Station	,Offset	,Elevation	,Cut	,Fill	,Point ID
0+41.304	,L 82.27	,841.839	,1.731	,	,
0+86.930	,L 82.20	,841.839	,2.400	,	,
1+31.460	,L 83.16	,840.449	,1.437	,	,
1+77.185	,L 84.28	,840.449	,1.644	,	,
2+22.791	,L 88.96	,840.598	,1.766	,	,
2+68.853	,L 87.43	,840.598	,1.501	,	,
2+09.384	,L 14.36	,838.172	,	,0.630	,Manhole

Station Store

Station Store is a pure calculation routine that will create points based on a station and offset from an alignment. The alignment may be defined as a centerline, a 3-point arc, an arc defined by a PC, Radius and PT, a selected polyline, or a sequence of points. The user may also assign an elevation to the calculated point. Station Store is useful for calculating right-of-way locations, which are typically defined as station and offset. Station Store might also be used to enter elevations of pipe culverts, for example, where inlets and outlets are located at distinct stations, offsets, and elevations. Then the two calculated points at the inlet and outlet can be used within Stakeout Line to stake any point along the culvert, with the cut/fill calculated. Although the command Stake Centerline, found within Stakeout Line/Arc, will directly stakeout a particular station and offset to a centerline, some users prefer to pre-calculate the station and offset and assign a point ID, then stake by point ID. Station Store permits this pre-calculation of points at any station and offset.

The very first screen within Station Store offers several methods of defining an alignment, similar to Stake Line/Arc.

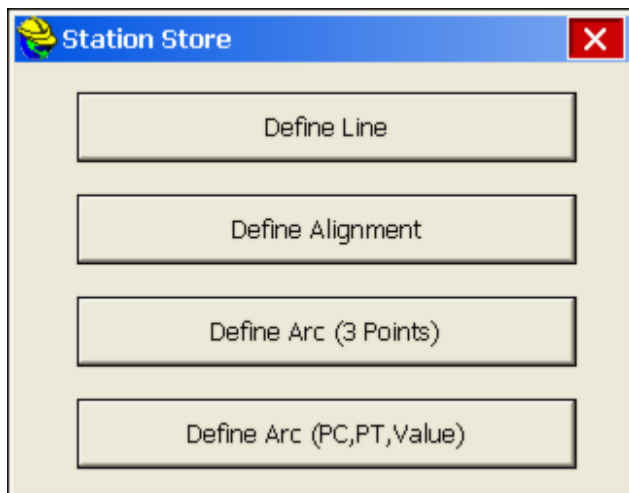

The following screen is where you enter the station, offset, and elevation to compute and store a point location.

Station Store

Starting Sta: 100.0000, Ending Sta: 834.0870

Station: 567.1750

Interval: 50

Offset: 65.451

Left Right

Elevation:

Segment (H): Spiral (V): None

Point ID: 9 **Store**

Description: 567.1750 L65.451

Store Multiple

In this example, a right-of-way point on a metric-based horizontal alignment is calculated at 0+567.175, offset left 65.451 meters, and assigned point ID 9. Note that the program detects that point 9 is within a spiral curve segment of the defined alignment.

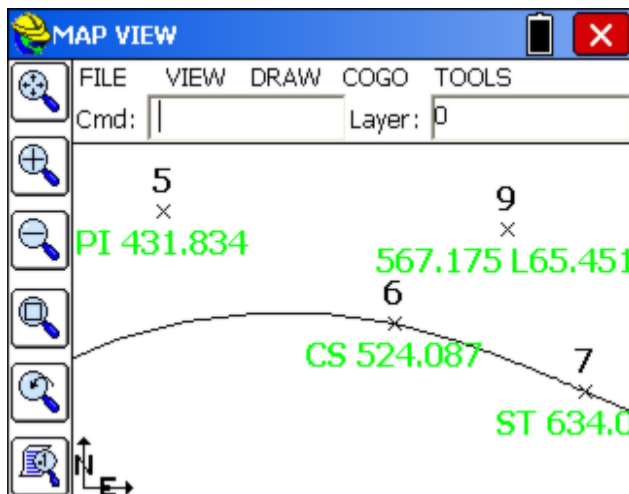

The description is fixed as the station and offset, but can be edited using the command Keyboard Input or File, Points. The "Interval" option is not typically applied, unless Store Multiple is selected, in which case points will be stored sequentially at the entered offset from the starting station to the ending station as entered. In addition to calculating a station and offset perpendicular left and right, skewed pipes can be calculated by selecting the "skew back" or "skew

ahead" options in the pulldown list where "offset" is the default. A zero skew pipe is perpendicular to the horizontal alignment. So a "skew ahead" of 20 degrees would be 20 degrees "ahead" of the 90 degree offset, or 70 degrees to the right of the forward tangent. Here is an example where both ends of a pipe are calculated, with the resulting graphic shown below. Decimal places on the stationing are set under File, Job Settings, Format Tab, Station Display.

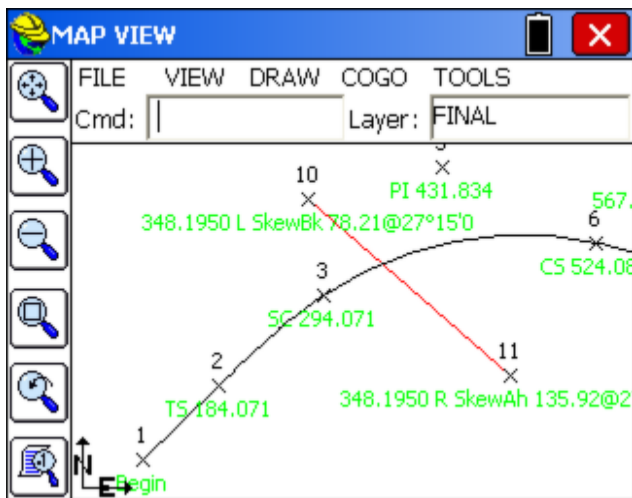

Transformation

This command allows you to translate, rotate, and/or scale points in the current job. Any point drawn on the map screen will be updated automatically in addition to updating the coordinates.

All three transformations can be performed individually or all at once if desired. You first fill out the options in one or more of the tabs (Translate, Rotate and Scale), and then you press Enter and obtain a second screen where you fill out the range of points to transform.

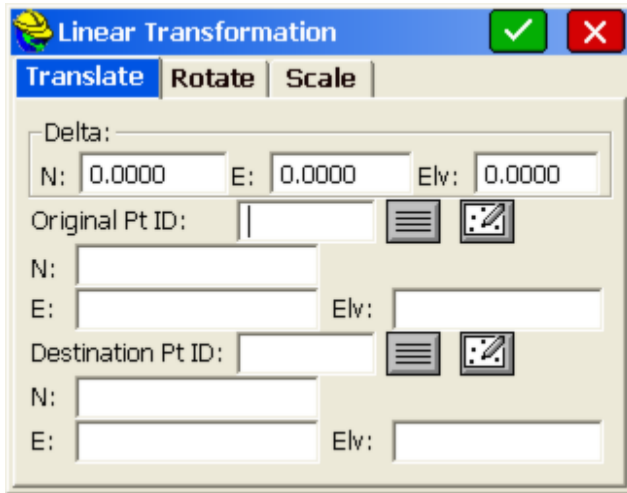

Range of Points: Enter the range of points to translate. Ranges can be entered in the following format: 1-20,32,40-45, etc..

Add to Point Numbers: Enter a number to add to existing point numbers when creating new point numbers. This option is not available when overwriting your existing point numbers. See example below under *Use New Point Numbers*.

Use New Point Numbers.

Overwrite Existing Point Numbers: Overwrites the existing point coordinate data with the new coordinate data.

Use New Point Numbers: Uses new point numbers for the new coordinate positions while keeping the existing point numbers and coordinate data. Each time a point is to be overwritten, you will be prompted whether to overwrite or use a new point number. This method is only recommended when you are transforming very few points and wish to give each a specific point number assignment.

Store in New CRD File: This option writes the transformed points to a new CRD file while keeping the existing point numbers and coordinate data. You may also choose to input a number for Add to Point Numbers, but this is not required.

Translate

On the translate dialog, enter in the Delta North, Delta East, and the Delta Elevation. These values represent the change in the original coordinate values and the desired coordinate values. When complete, select the **OK** button on the dialog, or navigate to the **ROTATE** or **SCALE** Tabs for further data input.

The lower portion of the screen shows an alternate method of defining a translation by comparing an original point to a destination point. Data entered here, as point ID or directly entered northing, easting and elevation, will lead to computation and display of the delta N, delta E and delta Z in the upper portion of the screen.

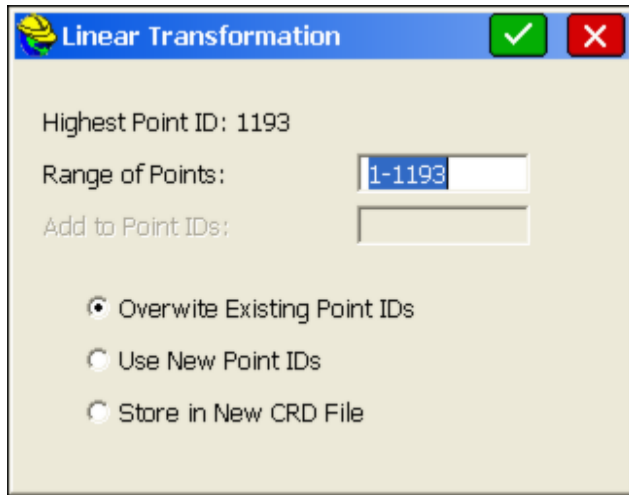

When **OK** is pressed, a second screen appears which controls the range of points to be translated.

Assuming you have 55 points in your file, you could "preserve" these 55 points by adding 100 to the point numbers, and saving the transformed points as 101 through 155. If you choose **Overwrite Existing Point IDs**, the Add to Point Numbers option is not available. If you choose **Use New Point Numbers**, then you will be prompted to enter a new point number for each existing point to be overwritten (recommended only when you are overwriting a few points). You can even store the transformed points in a completely new CRD file by selecting **Store in New CRD File**.

Raising and Lowering Elevations: Users often ask, "How do I raise or lower elevations on a range of points?" The answer is the **Translate** option in the **Transformation** routine. To adjust elevation only, enter only the delta elevation (leave Northing and Easting at 0 translation).

Rotate

The ROTATE tab is used to rotate points in a coordinate file. Enter the desired degree of rotation into the degree of rotation data field. Specify the rotation base point. This can be accomplished by either entering the point number of the desired point manually, or by selecting the point using the **List** or **Map** icon. You may also enter in coordinates for the rotation point if the point is not present in the coordinate file. Lastly, you can define the rotation by referencing two points (such as "From 1, To 2"), then specifying the desired new bearing for these points. Even the new bearing itself can be computed from two points used as a reference.

The second screen appears, which allows you to set the range of points to transform and choose how to store the newly calculated points. For all rotations, the rotation value is written into the RW5 file as dd.mmss (the current angle format).

Scale

The scale tab is used to scale the points in a coordinate file. The northing, easting, and optionally, the elevation, are multiplied by the specified scale factor. Enter the desired scale factor in the scale factor field. Select the base point by entering the point number of the desired point manually, or by selecting the point using the **List** or **Map** icon. You may also enter coordinates for the scale base point if the base point for scaling is not present in the coordinate file. The coordinate of the base point will remain unchanged. All other points will scale. If the **Ignore Elevations** toggle is enabled, then only the northing and easting values are scaled. Note that you can scale your points from base coordinate 0,0,0 by entering a scale factor and answering Yes to the warning screen.

Raw Data Records

The transformation raw data records are expressed as one string per command with the values separated by spaces. These records will be recorded to the raw data file for processing purposes so that all Carlson processors will recognize the records and perform the transformation during re-processing.

- **TRANSLATE:** Range Dx Dy Dz Process_Zero_Z
- **ROTATE:** Range Angle Base_Y Base_X
- **SCALE:** Range Scale Base_Y Base_X Use_Z
- **ALIGN:** Range From1 To1 From2 To2

Example:

```
CC,Translate,8-9 200 50 0 0
```

```
CC,Rotate,7 33.1234 79613.662 15619.725
```

```
CC,Scale,7 1.5 79613.662 15619.725
```

```
CC,Align,8-9 8 6 9 7
```

Calculator

This command eliminates the need to carry a separate calculator in the field. The calculator can be used to do scientific computations, standard calculations, conversions, triangle calculations, including angles, and curve calculations.

Standard Calculator

Most basic calculations can be performed using this tab in the calculator. Memory functions are also available.

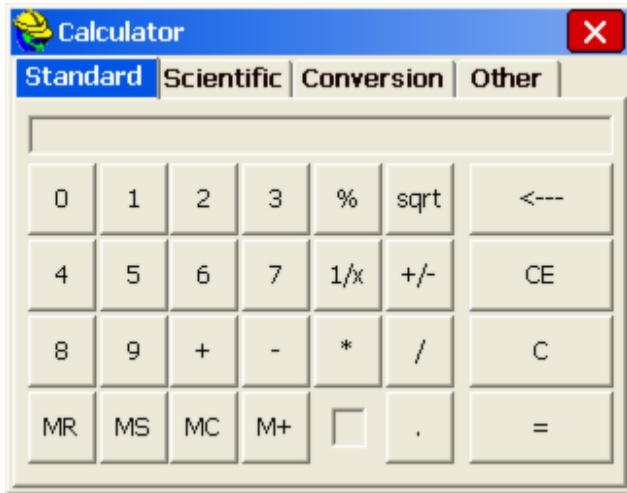

Scientific Calculator

Values can be entered on the X register by typing on the keypad. The values can be rolled up and down with the up and down arrow keys and the **Roll** and **RollD** buttons on the screen. The **Enter** key finishes the entry of a number and pushes the stack. The **C** on the touch screen clears an entry. Additional functions on the screen can be obtained through touching the scroll [**<**] and [**>**] area of the screen.

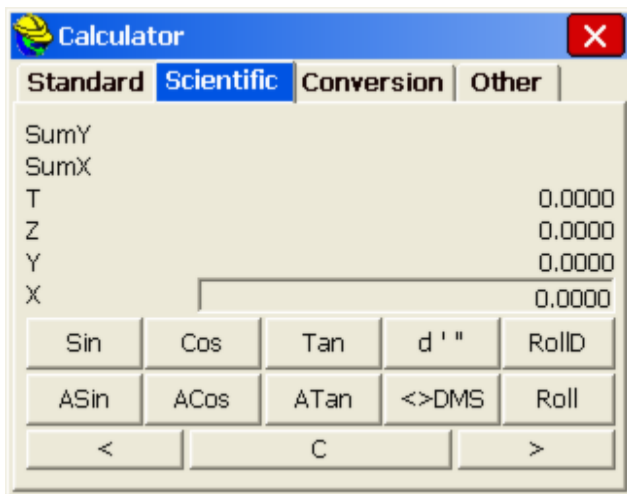

Conversion Calculator

Conversion values can be entered for various unit types and scenarios.

- **M to Ft:** This option provides for conversion between many units. Enter a value in any field and press **Enter** to find the conversion value. The following units are available in Feet, Meters and International Feet Degrees, Minutes, Seconds and Gons/Grads and Decimal Degrees

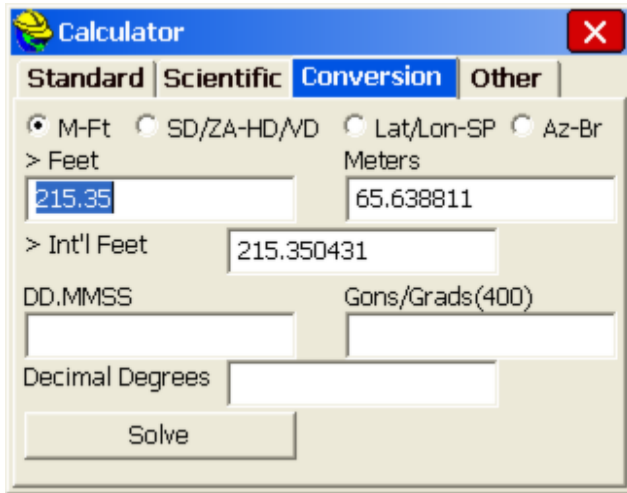

- Slope Distance to Horizontal Distance:** This option allows you to convert slope distances with zenith angles to horizontal distances and vertical differences, and vice versa. See figures.

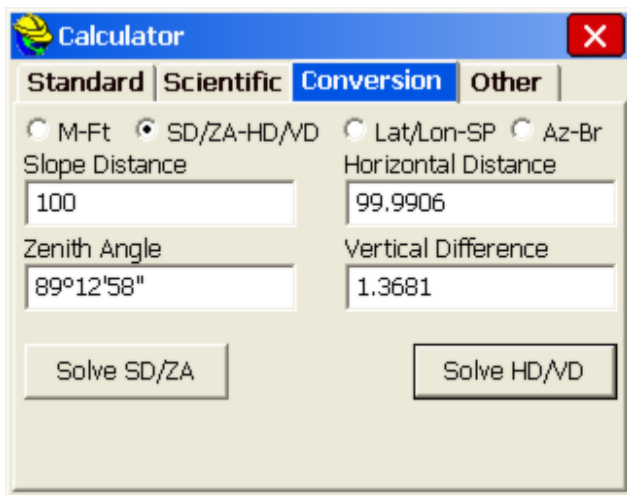

- Lat/Lon-SP:** This option allows you to convert from Latitude/Longitude to grid system coordinates and vice versa. If you are configured for U.S. State Plane Coordinates, the routine conveniently displays your zone, and you can even change zones for quick calculations without altering your GPS zone settings in **Job Settings**. Otherwise, the calculation is based on your Job Settings GPS Zone. To solve for northing and easting, fill in the latitude and longitude and press Solve N/E. To solve for latitude and longitude, fill in the northing and easting and press Solve Lat/Long. You can set the state plane zone at the bottom of this dialog.

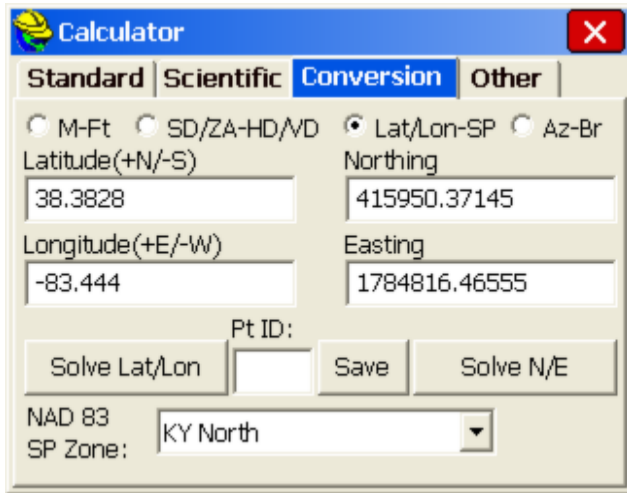

After completing a conversion, you may enter a point ID and press **Save** to save the coordinates to the current job. You can also change the type of transformation or zone system used. If you don't want NAD 83 (primarily used in the U.S.) you can go to **Job Settings, GPS** and change the Transformation type. For example, you could change the Transformation to UTM or NTF-France. Then, back in Calculator, your coordinate to Lat/Long calculation would be based on the configured transformation. Note that when converting Grid System Coordinates to WGS84 coordinates and going WGS84 to Grid, the geoid separate file (if any) is applied to the calculation.

- **Az-Br:** This does a straight, simple calculation converting azimuths to bearings. A prime example, shown below, would be converting an azimuth of 119.2547.

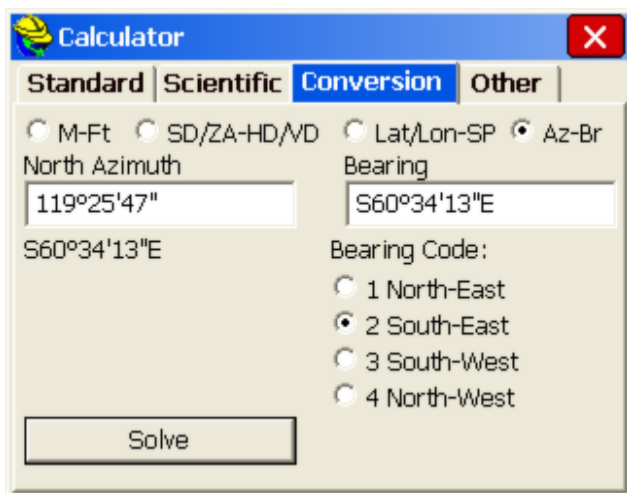

Other Calculations

There are two types of calculations that can be performed from the OTHER tab. Click the large, square icons to go to the Triangle or Curve calculator.

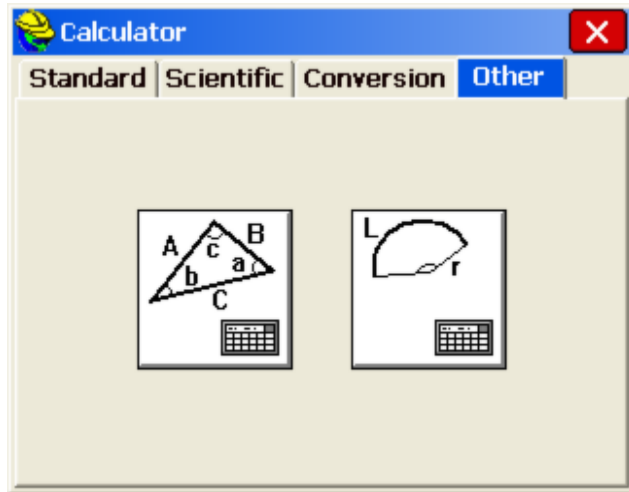

Triangle Calculator

The figure below shows the Triangle calculator. The top of the dialog box indicates the mode of calculation. To change the mode, simply use the pull-down and to select the desired mode.

- Side-Side-Side
- Angle-Side-Angle
- Side-Angle-Angle
- Side-Angle-Side
- Side-Side-Angle

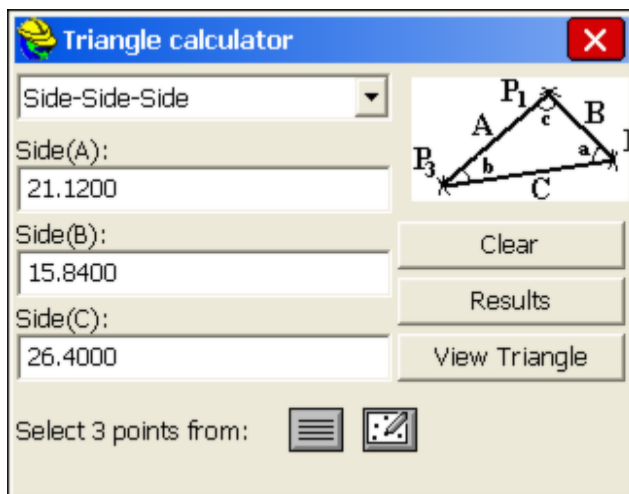

After choosing a mode, simply apply the values to the appropriate blank and hit **Solve**. Points from your current job can be selected to fill out the blanks as well. The points can be selected from the screen or from the point list by picking the appropriate button icon. After the calculations have been performed, you will see the **Clear**, **Results**, and **View Triangle** buttons. **Clear** will clear the entry fields. **Results** will show the results dialog again. **View Triangle** will draw the triangle on the screen connecting the points chosen for the calculation. The triangle calculator, using 3 points, is a convenient way to calculate the interior angle between 3 points. For example, if you were setup on 1, backsighting 10, and turned a 90 degree angle to 21, then the triangle defined by 10 to 1 to 21 would indicate a 90 degree angle at point 1.

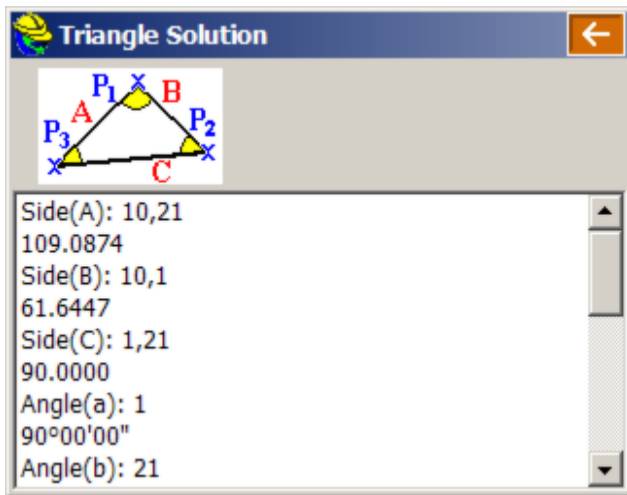

Curve Calculator

The figure below shows the **Curve calculator**. Simply use the pull-down at the upper left to select the desired method of curve calculation.

- Radius-Delta Angle
- Radius-Chord Length
- Radius-Arc Length
- Deg. of Crv.-Delta Angle
- Deg. of Crv.-Chord Length
- Deg. of Crv.-Arc Length
- Delta Angle-Chord Length
- Delta Angle-Arc Length
- Chord Length-Arc Length

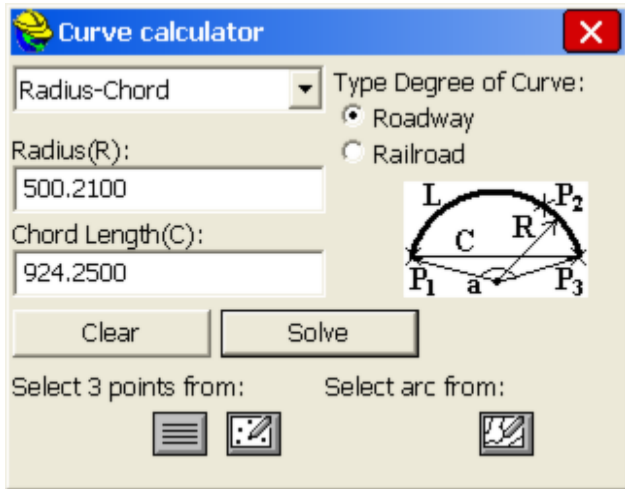

The type of curve can be toggled between roadway and railroad. Values can be entered into the blanks by keyboard entry, by selecting points from the current job, from a point list, from the screen, or by selecting an arc drawn on the screen. Once the values are entered, the results are displayed on the screen. The results can be viewed by selecting the **Results** button. The curve can be viewed on the screen by selecting the **View Curve** button.

Manual Traverse

This command allows for manual entry of angles and distances, and calculates sideshots or traverses from a known occupied point. If the direction is defined by a bearing or azimuth, a backsight point is not required. If the direction is defined by angle left or right or a deflection angle left or right, then a backsight point is required.

Manual Traverse is actually one of three options for manual traverse and sideshot entry. A second option is to go to the Map screen, and at the command line (Cmd:) enter "I" for inverse, to inverse to an occupied point, or from backsight point to occupied point, then "T" for traverse or "S" for Sideshot, using angle codes 1-NE, 2-SE, 3-SW, 4-NW, 5-AZ, 6-AL, 7-AR following the prompting for angle and distance entry. This style works strictly off the keyboard and does not require any screen tapping to switch from traverse to sideshot to inverse. The points plot on the screen as you go. A third option for traverse and sideshot entry is to set the equipment type to Manual Total Station, and enter the traverse and sideshot data within the **Store Points** command. All three of the methods will store data to the raw survey file for re-processing, and will allow entry of instrument heights and target heights. In the Map screen, **Traverse Defaults** (TD) will turn instrument and target height prompting on and off. All three methods allow for zenith angle prompting as an option.

The command centers around one main entry screen. You must enter an occupied point for traversing. You must also enter a target point number to calculate.

- Horizontal Angle:** You must select a horizontal angle method. Options here are AR (angle right), NE, SE, SW, NW, AZ, SAZ (south azimuth), AL (angle left), deflection left, and deflection right. If a bearing or azimuth is selected for traversing, the backsight point number will become inactive. Only an occupied point is required to traverse forward by bearing or azimuth. All other turned-angle methods will require a backsight point number. The stored descriptions for the occupied point and backsight point will display as shown above (TRV MAG and TRV N in this case). Occupied points and backsight points can be selected from the list or the map using the appropriate icons. You can also enter point-defined angles, as in 6,7 for the direction from 6 to 7, or 6,7+90 for 90 degrees to the right of the direction of 6 to 7.
- Elevation/Vertical Angle Method:** There are many ways to calculate a vertical differential between the occupied point and target point. The most common method is zenith angle (ZE). Manual Traverse also offers vertical angle, delta Z (elevation difference), slope by percent (SP), slope by ratio (SR), and known elevation (Z). To get the slope from point 6 to point 7, switch to SP mode and enter 6,7 for the slope.
- Distance Method:** There are four methods of distance entry: **Horizontal Distance** (in which case the elevation line is inactive), **Slope Distance; Slope Distance, No Elevation;** and **Horizontal Distance, No Elevation..** Both Slope Distance methods will prompt for vertical angle/zenith angle, etc., but Slope Distance, No Elevation will calculate a zero-elevation for the target point number and will reduce the slope distance by the effect of the vertical angle/zenith angle. You can also enter the distance in the form of 6,7 for the distance from 6 to 7, or as 6,7/2 as half the distance from 6 to 7. Note that if you wanted to interpolate a point 12 midway between 6 and 7, you can use all 3 edit boxes to accomplish this. The azimuth or bearing could be entered as 6,7. The slope would be entered as 6,7, and the distance would be entered as 6,7/2. So if point 6 is elevation 100 and point 7 is elevation 101, point 12 will have elevation 100.5.

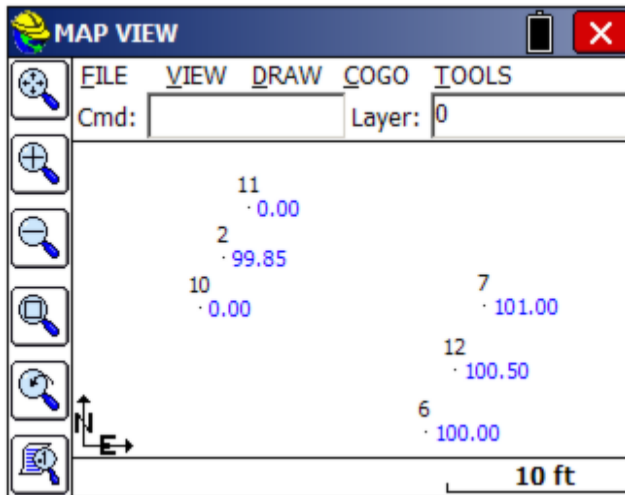

- **Enter Elevation:** If **Enter Elevation** is enabled, a check screen is activated to display the calculated elevation. From here you can override the calculated elevation with a new elevation. This option is useful in combination with Horizontal Distance for calculating points at a known distance and fixed elevation.
- **TR Mode:** Enabling **Traverse Mode** will cause the routine to “traverse up” to the target point number, so that the new occupied point number will automatically change to the last target point number, and the new backsight will change to the last occupied point. You can always manually change the fields for occupied point and backsight point and “force” a traverse, but enabling **Traverse Mode** will update these fields automatically, so that you immediately “move up”, and are awaiting the next angle and distance entries. With TR Mode disabled, **Manual Traverse** defaults to sideshot mode.

When you are entering in the horizontal angle, distance, or elevation/vertical angle information, the program displays the current mode as an extra confirmation at the bottom of the screen. Hitting **Enter** from the last entry line, or tapping **Calculate**, or entering a **C** for calculate, will solve for the coordinates and display them at the bottom of the screen. Hitting **Enter** again, tapping **Store**, or entering **S** will store the points. Before storing, you can also tap the **Map** icon to see the location of the calculated point, in reference to the occupied point and backsight point.

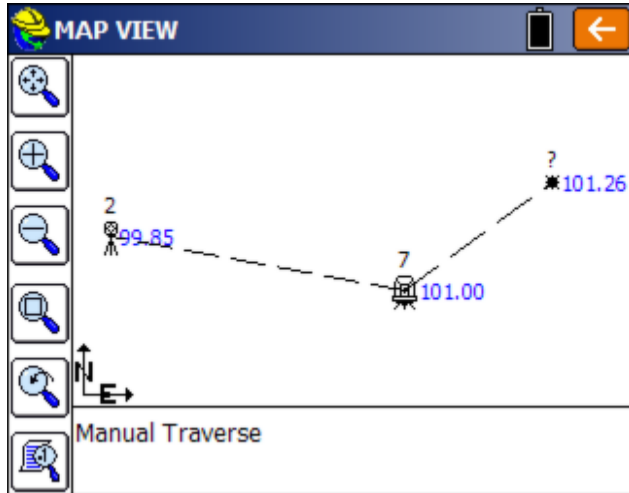

Click **Back** to return. You always have the option to enter new angle and distance information, Calculate, check the Map, then Store, as desired. **Point in Direction** offers the flexibility to check point locations graphically prior to storing.

- **EI/Off:** If EI/Off is clicked on for Elevation mode, a “check screen” is activated that allows you to see the calculated elevation and potentially override it with a new elevation. This option is useful in combination with **Horizontal Distance** for calculating points at a known distance and fixed elevation. This screen also allows you to offset the point perpendicular to the computed traverse leg. Enter positive for right and negative for left.

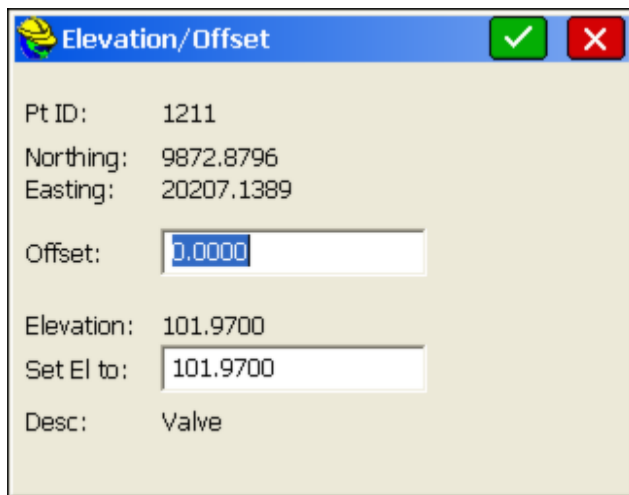

Point Average

Standard Point Average: The standard **Point Average** command works

especially well in conjunction with the Auto Store by Interval command found in the Surv menu. If you set the Auto Store by Interval command to storing by Time rather than Distance, you can also set the maximum number of points to store (eg. 100), and in this way, store a specified number of readings at any desired time interval. Stored points will auto-increment from the entered Starting Pt ID. If the "Record Max Number of Points" is not clicked On, then storing will occur until the user ends the process by clicking the Red Stop icon or the Red X in the subsequent screen. The Auto Store by Interval dialog is shown below:

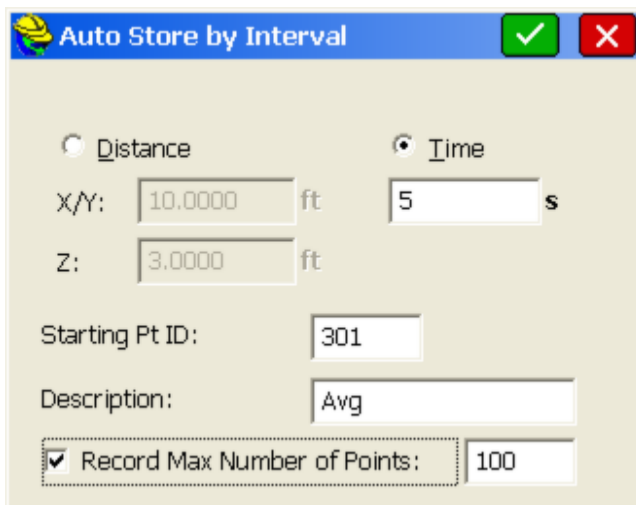

Point Average is a processing command useful in obtaining both the average value of a set of readings as well as estimates of the variation of the data. If 100 points are measured from 301 to 400, the calculation of the average is shown below:

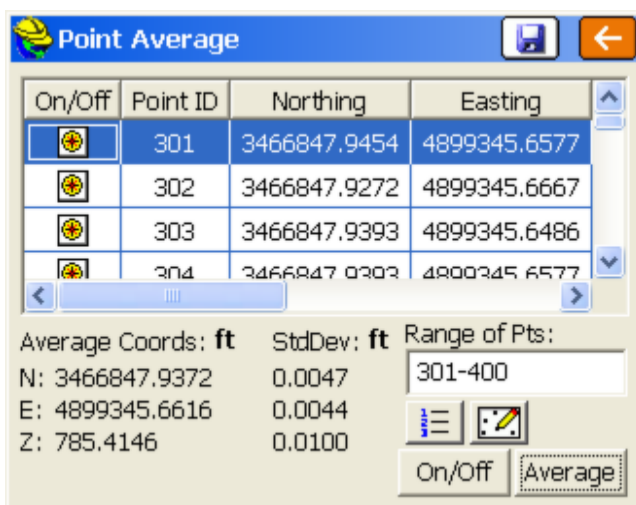

Individual points can be turned on and off for purposes of the calculation. The standard deviation is presented. The range of points is entered using the standard SurvCE convention of dash and comma separators. For example to average points 401 to 410 as well as 415 and 420 to 425, the entry format would be 401-410,415,420-425. Additional points can be added using the "From List" and "From Map" icons. When new points are added or points are turned on or off, clicking Average initiates a fresh calculation. To store the averaged coordinate values as a point ID, click the "Store to Disk" icon at the top of the screen. Click the back arrow to return to the main COGO menu screen.

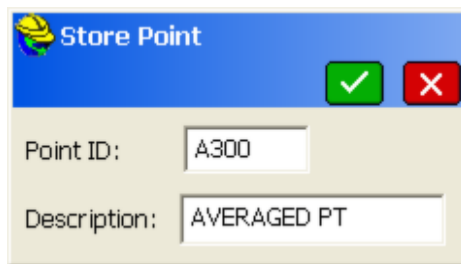

GNSS Analysis Point Averaging: If under Job Settings, Options tab, "Apply GNSS Analysis" is turned on, then the Point Average methods and screen dialogs are completely changed within **Point Average**. This analysis approach deals with one Point ID at a time, and works if multiple measurements were taken on that Point ID, either as distinct Store Point exercises or as A for Average within Store Points. The method, however, is designed for a field procedure of distinct single point measurements using Store Point, storing the same Point ID, typically at intervals over a period of time, capturing different satellite configurations. By using this procedure, greater point positional certainty can be obtained through statistical analysis. The Store Points option of A for average can work similarly if a longer time interval between measurements is used, but the advantage of the individual Store Points approach is that the GNSS rover can be used for other work between returning to the same point to measure it again with the same point ID. So if you were mixing topo or data gathering work with key point, boundary point measurement, you could measure the key point, do 30 minutes of topo, measure the key point again, do another 30 minutes of topo, and repeat that procedure, accumulating multiple data on the same point ID for the key point, in preparation for "**GNSS Analysis Point Averaging**". If all of your work was "key" point measurement, you could simply sequence from one key point to another, returning to the same points over an extended time period. Then the GNSS Analysis method will calculate the measured points to greater certainty (as reported statistically), with blunder detection and blunder removal.

With GNSS Analysis, extensive testing has shown reliability of between 1 and 2 centimeters with multiple readings, but with statistical standard deviations of as little as 3 millimeters. Blunder detection is accomplished using the Chi Square Variance Test. The parameters and error estimates are hard coded in the preliminary release of this feature, based on thousands of point measurements. This trial, fixed parameter feature is provided with the caveat that most testing has been conducted with Topcon and Altus GNSS receivers, and for fixed antenna

conditions involving low and secure antenna positions. The parameters for statistical analysis may not apply to your specific condition. These parameters will be converted to user-defined variables with suggested ranges for settings in subsequent releases based on reports from trial usage with a wider range of equipment.

Preconditions to GNSS Analysis: The following preconditions must be set for GNSS Analysis.

- The GNSS Receiver itself must offer the option to store GPS vectors and make this available to Carlson Software.
- **File, Job Settings, Options Tab, Apply "GNSSAnalysis" to average identical GPS Pts: IDs or IDS+Descs**
- **Both the CRD file AND the associated RW5 file of the same name must be on the same data directory:** If you just copied a CRD file to a data collector without the associated RW5 file, GNSS Analysis will not work. The companion, same name RW5 file must be present on the same directory. Plus the data in the RW5 has to contain RMS values, DOP values and vector data, stored based on the following two preconditions.
- **File, Job Settings, Options Tab, Store GPS Accuracy in Raw File On.** This stores the HRMS, VRMS, PDOP and other DOP values necessary for the statistical analysis.
- **File, Job Settings, Options Tab, Store GPS Vectors in Raw File On.** This stores the base to rover vector data necessary for the least squares calculations used.

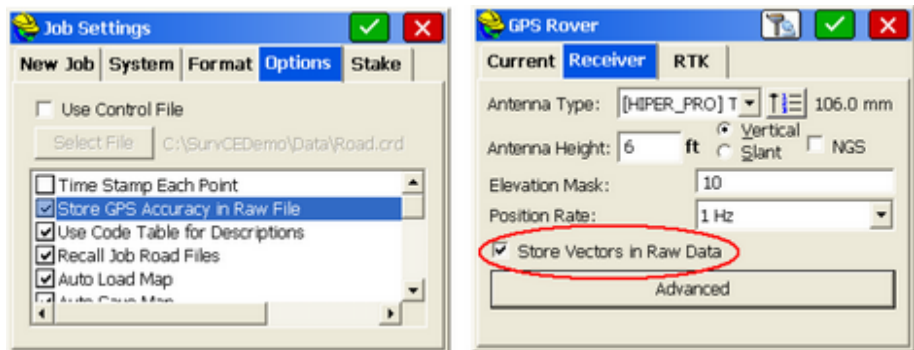

Because it is important to use the same Point ID, and because SurvCE will naturally increment points, it is also useful to turn on "Avg Same Point ID" in the Height/Description prompt screen as shown below:

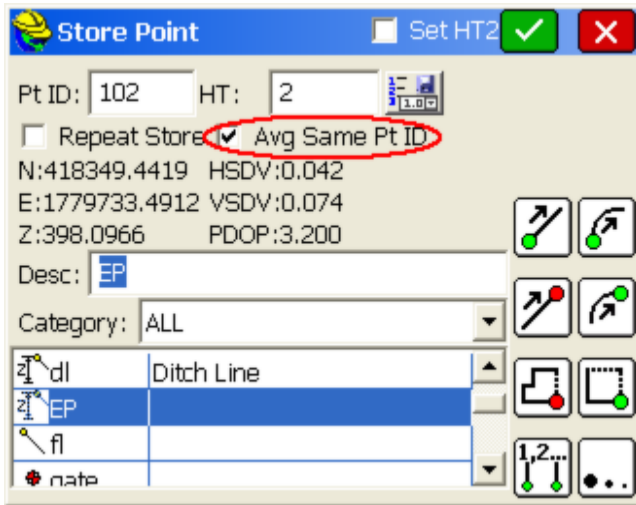

In this mode, if you measure a point for the second time, with the same ID, the program will assume you wish to overwrite it, will avoid the Point Protect screen and will display the duplicated points in a list as shown below: And on the next measurement, after two appear in the list, the auto-increment is disabled and the program will remain on the same Point ID until you enter a new Point ID to measure. In this dialog, the point you choose to store can be averaged, with any individual point turned on or off in the left column. Click the Store Icon to store the point. Otherwise, the last point measured will be stored. This Point Average screen shown below left appears within the command Store Points itself with the option "Avg Same Point ID" on, as above. The screen shown below right appears if GNSS Analysis is on, Store GPS vectors is on and Store GPS Accuracy in Raw File is on. So the Store Points screen itself shows, in effect, the same dialogs as appear in Point Average, whenever "Avg Same Pt ID" is on. In that sense, the Point Average command is a way to recall measurements and do point averaging later, after you take field measurements. Conducting the averaging by standard and advanced "GNSSAnalysis" methods can occur while in Store Points with "Avg Same Pt ID" on or later by going to Point Average. Observations appear as 0 in upper right of dialog, until the minimum of 3 raw measurements for calculation purposes are obtained. Clicking Enter proceeds to the next measurement, equivalent to tapping the Green Check. So when repeating point IDs and remeasuring points, with Hgt/Description Prompt On, you can take measurements using GNSS Analysis with Enter for the measurement, Enter for the Hgt/Description Prompt, Enter for the Analysis review. With Hgt/Description Prompt Off in Configuration, each measurement would be 2 Enters.

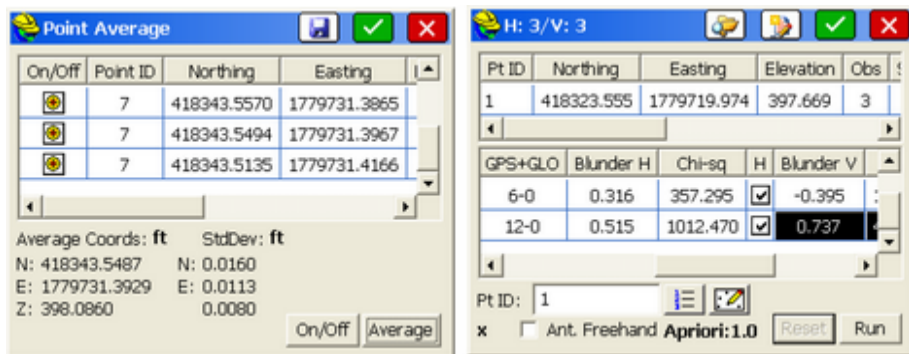

Whether working from within Store Points or within the Cogo Menu, Point Average option, with GNSS Analysis on, AND with both vectors on, leads to analysis options as shown below:

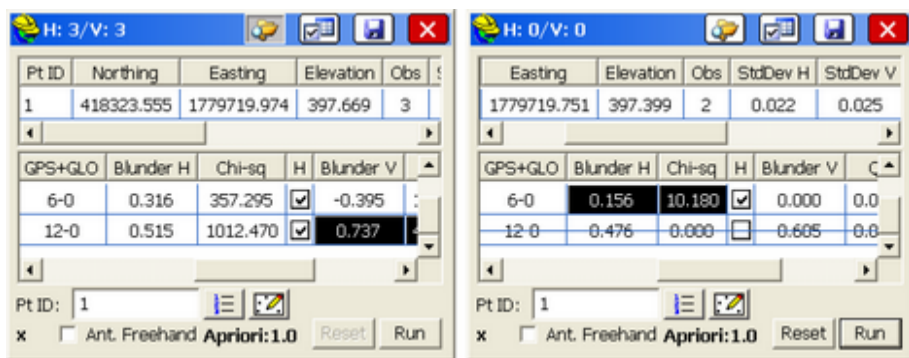

The program defaults to the display above right, by auto-running the blunder removal until H=0 and V=0 in terms of potential blunders. By clicking Reset, the "original" blunder status of all observations can be viewed. This example has only 3 field measurements, and when the 3rd measurement is removed, the remaining two observations pass the statistical analysis parameters. After clicking Reset, you can click Run to allow the program to automatically remove blunders, distinctly in the H and V columns, to obtain the maximum remaining number of measurements that pass the statistical test. With Chi-Square set to approximately 23, the program seeks to get the maximum F test value for the x,y (H) calculation around 10 or less and the maximum Q value for the Z (V) under 1.

If you don't use "Run", you can allow the program to present the highest contributor to errors and then remove these one at a time. In this way, you are rejecting the single observation with the largest contribution to the sum of the squares (standardized residual). Repeat until all observations that qualify for rejection are removed. In the report, the External Reliability is the maximum point deformation, or the maximum effect of a theoretical undetected blunder on the final computed coordinate. The calculations use the covariance information found in the data accuracy estimates of the GNSS receivers. A least squares calculation is used to find the best center point.

Although designed for 5, 10 or more same points readings, here is an example of 3 field measurements and how the blunder detection works when identified and removed manually:

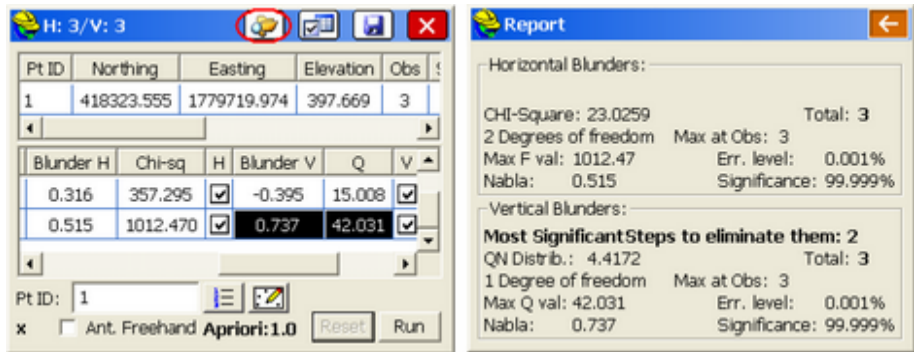

Start by entering the Point ID in the lower left of the dialog to study. Press Enter after selecting the point for the data to appear. The "worst" blunder is identified by highlighting to the left of the H or V column. So in this case, click of the V to the right of the highlight. Prior to doing so, if you click the Report icon (highlighted with red circle), you see the Report at right which shows the high F Value for the horizontal component and also high Q value for the vertical component. The process of removing blunders will reduce these values to acceptable levels (also accomplished automatically by tapping "Run"). So after removal of the first blunder (V), on the third observation, the next worst blunder appears below, which is the (H) on the same 3rd reading. Note that when one blunder on the same reading is already identified, the next blunder on that reading is identified by reverse coloring (here white, not dark):

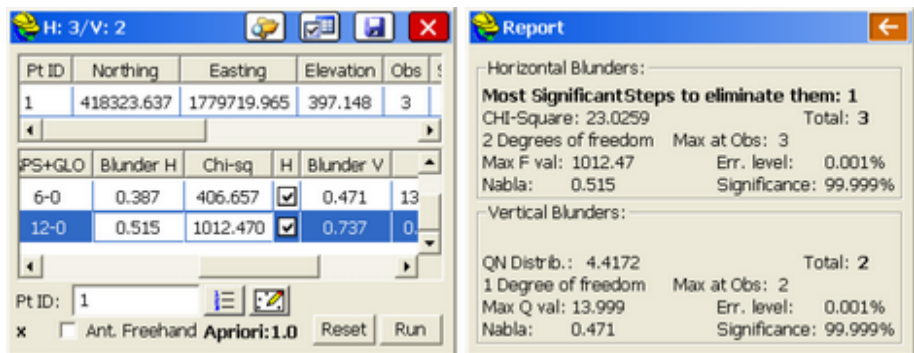

Notice how the Q value came down after removing the first vertical reading. Next, remove the "reverse highlighted" (H) reading for the third observation, which in effect eliminates that third reading altogether:

Pt ID	Northing	Easting	Elevation	Obs
1	418323.328	1779719.735	397.348	2

Chi-sq	H	Blunder V	Q	V	Date	Time
10.180	<input checked="" type="checkbox"/>	-0.026	6.011	<input checked="" type="checkbox"/>	13/27/02	18:54
10.180	<input checked="" type="checkbox"/>	0.026	6.011	<input checked="" type="checkbox"/>	13/27/02	18:54

Pt ID: 1

Ant. Freehand **Apriori:1.0** Reset Run

Report

Horizontal Blunders:

CHI-Square: 23.0259 Total: **0**
 2 Degrees of freedom Max at Obs: 2
 Max F val: 10.18 Err. level: 0.001%
 Nabla: 0.156 Significance: 99.999%

Vertical Blunders:

Most Significant Steps to eliminate them: 1
 QN Distrib.: 4.4172 Total: 2
 1 Degree of freedom Max at Obs: 1
 Max Q val: 6.011 Err. level: 0.001%
 Nabla: -0.026 Significance: 99.999%

With the third observation entirely removed, the horizontal blunders are eliminated (now 0) and maxF value is an acceptable 10.18. The vertical Q value is still at 6, and one more blunder has been identified that is "significant" enough that removal is necessary and recommended. This is the vertical reading on the first observation. Remove that to obtain the final result (use of observations 1 and 2 for horizontal, observation 2 only for vertical). Remember, remove to the right of the highlighted item (the H or V):

Pt ID	Northing	Easting	Elevation	Obs
1	418323.371	1779719.751	397.399	2

Blunder H	Chi-sq	H	Blunder V	Q	V	Date	Time
0.156	10.180	<input checked="" type="checkbox"/>	-0.026	0.000	<input type="checkbox"/>	13/27/02	18:54
0.156	10.180	<input checked="" type="checkbox"/>	0.000	0.000	<input checked="" type="checkbox"/>	13/27/02	18:54

Pt ID: 1

Ant. Freehand **Apriori:1.0** Reset Run

Report

Horizontal Blunders:

CHI-Square: 23.0259 Total: **0**
 2 Degrees of freedom Max at Obs: 2
 Max F val: 10.18 Err. level: 0.001%
 Nabla: 0.156 Significance: 99.999%

Vertical Blunders:

QN Distrib.: 4.4172 Total: **0**
 1 Degree of freedom Max at Obs: 2
 Max Q val: 0 Err. level: 0.001%
 Nabla: 0 Significance: 99.999%

Observation 1 was used for the H only, observation 2 for H and V and observation 3 was not used at all (those observations get a line drawn through as below). This same result is obtained by tapping "Reset". The next "worst" blunder is still highlighted, but there is no reason to continue the process--analysis parameters are satisfied.

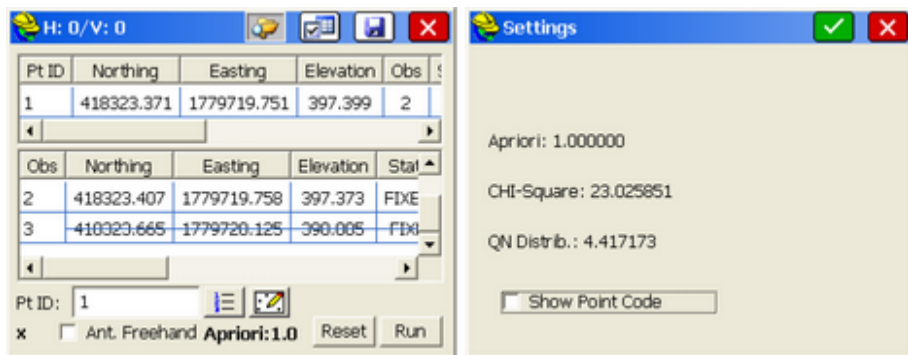

The "X" in the lower left of the screen is a somewhat arbitrary designation category. If 3 or more observations are used and pass the analysis, the quality of the observations are ranked 1 through 4 as follows: 1=city center, 2=rural area, 3a=farm land, 3b=forest, 4=unproductive land. The calculation will "qualify" for one of these designations with sufficient observations. Clicking the Settings button shows the hardcoded Apriori, Chi-Square and QN Distribution values. These values were selected based on extensive testing with a variety of commercial GNSS equipment. The "Antenna Freehand" setting will impact the calculation. If the GNSS antenna is on a fixed tripod, that resets parameters for the least squares calculations in terms of expected errors. If "Antenna Freehand" is clicked on, errors from a potentially moving antenna will be higher.

Here is another example, collected in the field using A for Average within Store Points. Note how all 5 observations are used.

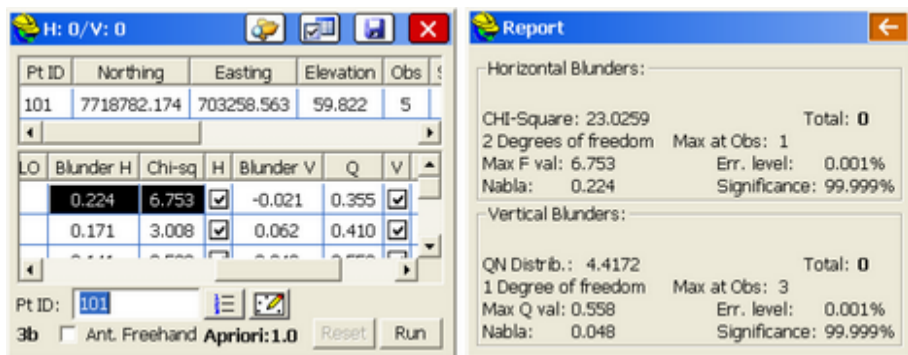

Shown below is the right-side presentation of the statistically averaged point, including external reliability values and data on the duration of the measurement (delay), which in this case was 13 minutes. Longer delay values are recommended to obtain different satellite constellation configurations.

H: 0/V: 0

StdDev H	StdDev V	ExReliab H	ExReliab V	Delay
0.050	0.051	0.200	-0.162	00:13:00

Obs	Northing	Easting	Elevation	Stat
4	7718782.094	703258.471	59.781	FIXE
5	7718782.102	703258.501	59.758	FIXE

Pt ID: 101

3b Ant. Freehand **Apriori:1.0**

ROAD

This chapter provides information on using the commands from the Road menu.



Centerline Editor

This command allows you to enter new centerlines, as well as recall and edit existing centerline files. Centerline files in SurvCE are ASCII files with a .CL extension. When the routine is selected, a dialog will appear in which you can load existing centerlines or begin entry of new centerline information.

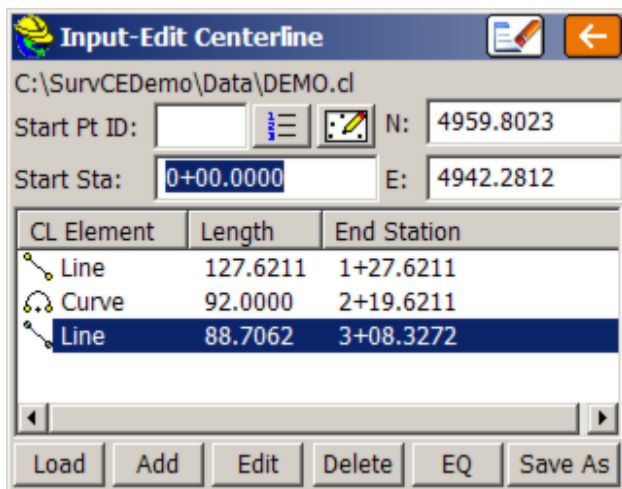

-  **Clear:** This icon, at the top of the screen, clears out all information in the dialog in preparation for entering a new centerline. With no centerline

file loaded or saved yet, the file name in the upper left is displayed as “None.”

- **Start Pt ID:** If the centerline starts on a point number that exists in your current coordinate (.crd) file, you can enter the point number here, and it will recall and display the starting coordinates. The point can also be selected from the list or map using the appropriate icons.
- **Start Station:** You must enter the starting station for the centerline. (“Station” is the same as the European term “Chainage.”) Many surveyors and engineers prefer not to start centerlines at station 0. If the job backs up or needs to start further back along the centerline, this method will leave you with negative stationing. There are three centerline “forms” as set in **Job Settings, Units**. A starting station of 1500 can be displayed as 1+500 (metric, US-style, showing whole kilometers left of the “+”), as 1500.000 (pure decimal chainage, common to Europe), and as 15+00 (feet, US-style, sometimes also used on metric roads in Canada), often referred to as “station 15 plus 00”. In all cases, you would enter it as 1500, but it would display in the correct format after pressing **Enter**. For example, you would see 1+500.0000 if configured to kilometers. The program will also accept use of the “+” in the entry of the station, and will convert to the configured form after you press **Enter**.
- **Northing, Easting:** If the northing and easting are not recalled from a starting point number, you will need to enter the northing and easting for the start of the centerline. It is not necessary to enter the northing and easting if you use the **Pick PL** (pick polyline) option for defining a centerline, since the starting coordinates of the selected polyline are automatically used, and would overwrite anything previously entered.
- **Load:** This command allows you to load an existing centerline for review or edit.
- **Edit:** Use this button to edit the highlighted element.
- **Delete:** Use this button to remove the highlighted element.
- **Add:** Returning to the starting dialog, you can add elements to get a centerline started. Typically, you will start with a line or tangent segment, but you can also start on a curve or spiral curve element. When you select **Add**, you get to choose which element to use. These options include:

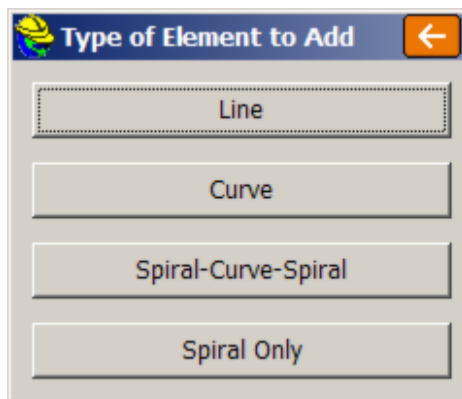

- Add (Line):** A tangent section of the alignment. This option allows you to enter a point ID or coordinates to define the end of the tangent, or enter the station, or distance and the direction. To force the element to be tangent to the previous element, toggle on the **Tangential to the previous elem** option. This will gray out the direction field and will compute the tangent direction and enter it for you.

Line(Tangent) Element	
Start Pt ID:	Sta: 4+08.3272
Nor: 5221.6515	Eas: 5167.8994
End Pt ID:	
End Station:	Northing:
5+08.3272	5317.3574
Length:	Easting:
100.0000	5196.8888
North Azimuth:	16°51'05.949923"
<input type="checkbox"/> Tangential to the previous elem.	

- Add (Curve):** A typical circular curve section of the alignment. The first element of the curve defines what the options for the second element can be (See Lists Below). The **RR** toggle allows the user to use Railroad definitions. The **Review** button allows you to verify the Tangent In and Tangent Out bearings or azimuths (depending on Job Settings, Format, Angle Display settings), as well as confirm PC and PT coordinates. For example, this allows you to verify computed Tangent Out bearings against paper plans, before continuing entry of new elements.

Curve Element ✓ ✕

PC Sta: 4+08.3272 ◉ Left ◊ Right

Radius >

Delta

R Pt ID: Nor:

Eas:

PT Pt ID: Nor:

Eas:

Tang to Previous Element

Chord North Azimuth: PT Sta:

RR

Radius >

Length

Delta

Length

Chord

Tangent

External

Mid-Ordinate

Degree of Arc >

Length

Delta

Length

Chord

Tangent

External

Mid-Ordinate

Delta >

Length

Length

Chord

Tangent

External

Mid-Ordinate

Chord >

Length

Length

Tangent

External

Mid-Ordinate

- Add (Spiral-Curve-Spiral):** The Spiral-Curve-Spiral element is really just two implementations of Spiral Only (line-spiral-curve and curve-spiral-line). The advantage of Spiral-Curve-Spiral is that it completes three elements at once and is a fairly common application on high-speed highways. This routine also allows the user to define the spiral-curve-spiral using known points as long as the spiral in and spiral out lengths are entered first.

Spiral-Curve-Spiral Element

Begin Sta: 4+08.3272

Spiral In Length: Spiral Out Length:

Data for Simple Curve: Left Right

Radius: Arc Len:

Tangent Out(Bearing):

End (ST) Sta:

Central PI Station:

From Points

Spiral In Length: None

Spiral Out Length: None

TS:	None	<input type="button" value="Get Coords"/>
SC:	None	<input type="button" value="Get Coords"/>
PI:	None	<input type="button" value="Get Coords"/>
CS:	None	<input type="button" value="Get Coords"/>
ST:	None	<input type="button" value="Get Coords"/>

- **Add (Spiral Only):** The Spiral Only element will handle a spiral between any line and arc segment (e.g. line-spiral-arc or arc-spiral-arc).

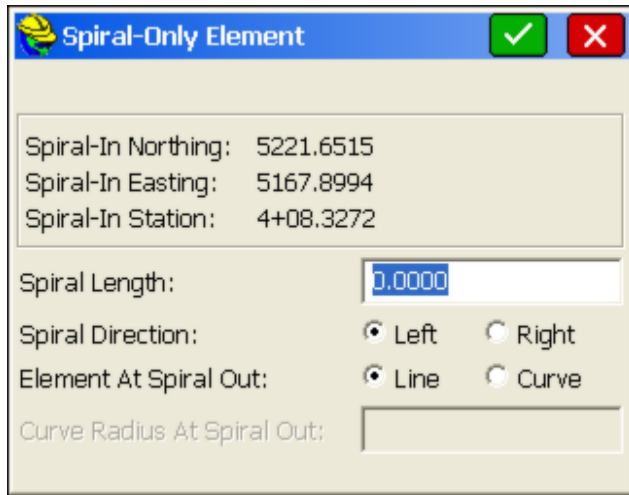

- **Pick PL:** This option is only visible if you Clear the dialog. With this option, you can pick a centerline from any screen polyline, including polylines with arcs. When you choose **Pick PL**, you are immediately presented with the graphic screen, where you can pan by dragging your finger across the screen, or zoom using the many zoom options. You can choose not to select a polyline (maybe there were none to select!) by pressing **OK** or **Enter**. When you select a polyline, it will highlight as a darkened polyline. After selecting a polyline and pressing **OK** or **Enter** you will see the polyline elements. Note that if you change the start station to 500, all the stationing for the polyline elements will change accordingly. This is also true regarding the starting northing and easting. If these are changed, all element coordinates will change accordingly, as can be verified using the **Edit** option.

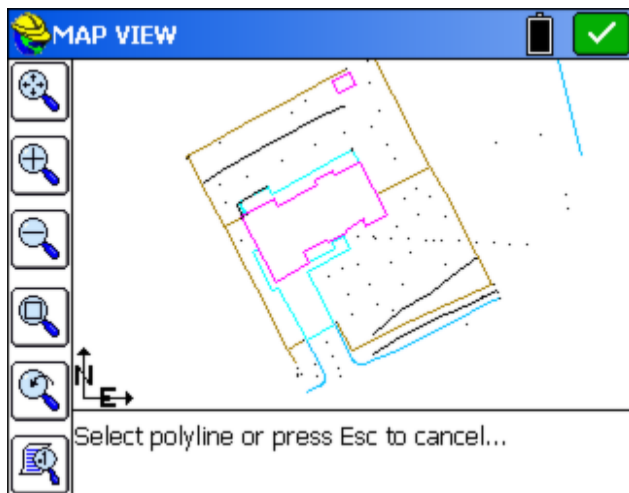

- **EQ:** The EQ button allows you to enter station equations.

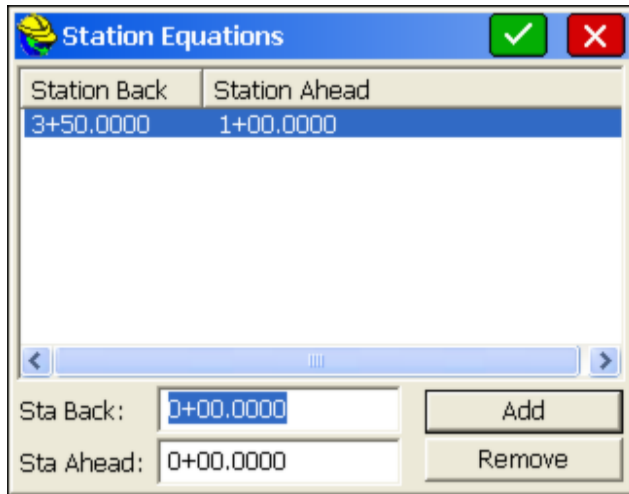

- **Save As:** This saves the file. Enter a name.

Note: You can create new points with Input-Edit Centerline. When you enter and save a centerline, it will prompt “Do you want to save centerline points?” You may answer **Yes** and save point IDs for the start, end, PI, PC, radius point, PT and any key spiral points found in the file. In the same way, a centerline that you load can be re-saved with new coordinate IDs assigned to all key points, as long as you make some change, like adding a point number to one of the Pt ID fields for a CL Element. If you answer Yes to Save Centerline Points, the dialog box below appears. If you have entered point IDs of your own choosing in the Input-Edit dialogs, use the upper option. The lower option will auto-number from the starting point ID without regard to any numbers you’ve entered, but will respect and not overwrite used points in the file. Points are not stored to the centerline file itself, so after loading a stored centerline, no point IDs will appear.

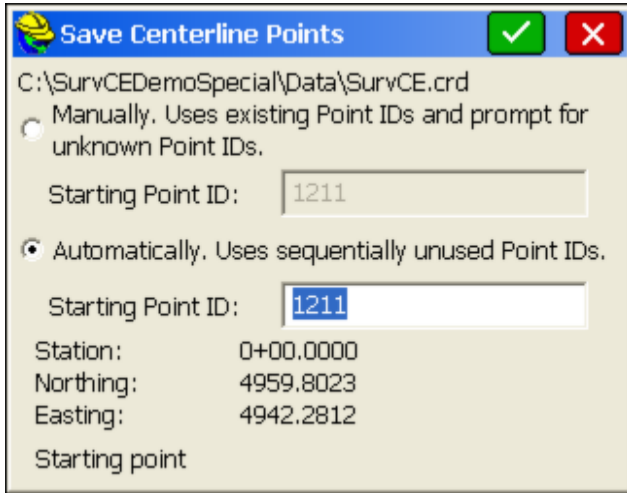

Draw Centerline

Draw Centerline will draw the selected centerline on the screen. All the zooming commands [Zoom In, Zoom Out, Zoom Window, Zoom Previous and Pan] are available to you in the **Draw Centerline** command. The program will automatically zoom to the extent of the centerline when drawn. If there are point numbers and polylines on the screen in that area, they will appear as well. This command only temporarily displays the centerline for reference and does not draw it on the screen as part of the dxf file associated with the job. To actually draw the centerline as a permanent feature (unless erased later), use **Map** (globe icon), **Tools, Centerline, CL to Polyline**.

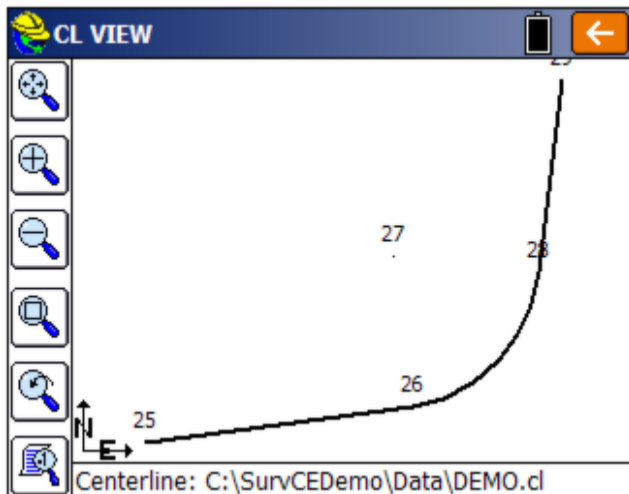

Profile Editor

This routine allows field entry of vertical alignment files for roads, sewers and other types of alignments. Vertical alignments can also be loaded and edited. In addition, high and low points can be calculated and the elevations of individual stations can be calculated. Vertical alignments are stored as files with a .PRO extension. Vertical alignments are typically referred to as profiles. In Carlson SurvCE, the station ranges of the profile and centerline do not need to match. As long as they have station ranges in common, any profile can be used with any centerline for all advanced Roading commands as well as Survey menu routines such as Offset Stakeout and Elevation Difference by Road Design files.

Profile Entry

Profiles are extremely easy to enter. When the command is selected, if no prior profile has been entered, you will encounter the blank Input-Edit Profile dialog. You can also obtain a blank screen and start a new profile by tapping the **Clear** icon (eraser) at the top of the screen.

PVI Station	PVI El	Slope %	VC Lng
100+78.69	526.49	XXXXXXXX	XXXXXXXX
106+00	529.1	0.5007	600
114+29.25	520.8075	-1	600
122+52.25	541.3825	2.5	600

Check Sta: 107+25.5

El: 527.4642

Show Zeroes
 Slope as Ratio
 Circular Curve

Load Add Remove High-Low Save As

- PVI Station:** PVI stands for Point of Vertical Intersection, similar to a PI (Point of Intersection) for the horizontal alignment. In some locations, the term VPI is used (Vertical Point of Intersection). You can start immediately by typing in the starting station under the PVI column. For our highway example, the starting station is 10078.69.
- PVI Elevation:** The starting elevation is 526.49. So simply press **Enter** and move from the PVI column to the PVI Elev. column and enter 526.49. Pressing **Enter** again moves onto the next PVI field, where you can enter 10600 for the next station, then 529.10 for the next PVI elevation.
- Slope %:** Once a second station and elevation are entered, the program will calculate the percent slope. Alternately, if you enter under the Slope % before entering the PVI elevation, then the program will calculate the PVI elevation. The slope column is a nice check against bad entries in the PVI elevation column. In other words, you often expect even slopes, and you can check the computed slopes against the plans. Slopes can be entered as ratios when that option is clicked, and if you click "Show Zeroes", the dialog will

show a consistent number of decimals (typically 4) in all columns, causing the data and decimal places to line up vertically.

- **VC Lng:** For road jobs, you can enter the vertical curve length in this column. This is the total length of the vertical curve. If the length entered is 600, this means that the vertical alignment transitions through a curve (parabola) beginning 300 units (feet or meters) before the PVI and ending 300 units after the PVI. If a vertical curve is uneven, that is, it transitions from, say, 400 feet before the PVI to 200 feet after the PVI, then the curve must be entered using the form 400-200 (the before and after distances separated by a dash). SurvCE assumes all vertical curves are parabolas (U.S. road industry standard). However, you can tap the circular curve option when that applies. For sewer and water line alignments, there is typically no vertical curve transition, so this column can be left blank, or 0s can be entered for vertical curve lengths.
- **Check Station:** When the profile for a highway job has been entered in a dialog, you can also enter a value to Check Stations. This feature is at the bottom of the dialog. This will check the grades at any desired station. When entering stations, you may include the "+" that is often used, as in 12+680.5 (English) and 126+80.5 (metric).
- **Load:** The Load command presents a list of all previously stored profiles. When one is selected, it displays the profile information in the dialog. To load a stored file, you simply enter the name (for example, "Demo"). No file extension is necessary. Alternatively, you can select a name from the list and accept it by pressing **OK** or **Enter**.
- **Add:** The Add button will create a new row at the cursor position with 0 entries (with the exception of slope, which will compute based on the 0 entries). If, for example, you touch line 1 (to move the blinking cursor to line 1--the first row), the **Add** command will allow you to insert a new row in the front of your profile. This would be necessary if you needed to start the profile at an earlier station. To add to the end of your profile, just click the down arrow key at the right until a blank line becomes available and make your new entries.
- **Remove:** This button deletes the current line.
- **High-Low:** This button can be used to calculate high and low points.

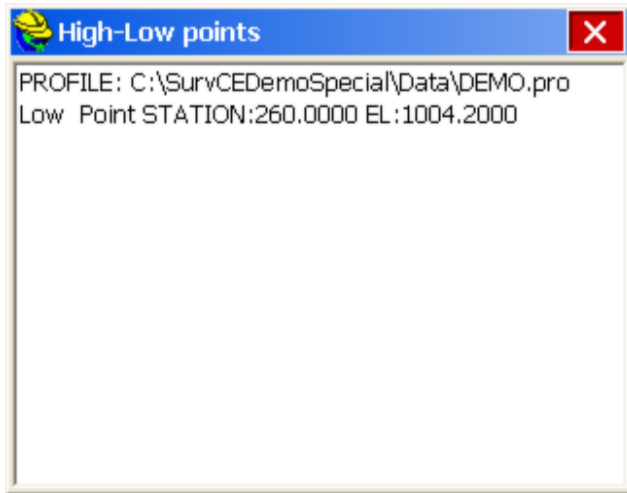

- **Save As:** This command will save your profile to a specified file name. There is no need to enter a file extension. If you want to save the file as Baker.pro, just enter "Baker". The **Save As** command will default to the current profile name. If you are entering a new profile, it will default to the current coordinate file name.

Draw Profile

The **Draw Profile** command will draw the selected profile on the screen. The profile will be exaggerated (typically 10:1 or 20:1) in order to maximize detail. You can control the vertical exaggeration by selecting the vertical scale icon, located at the lower left of the Draw Profile screen. All the zooming commands [Zoom In, Zoom Out, Zoom Window, Zoom Previous and Pan] are available to you in the Draw Profile command.

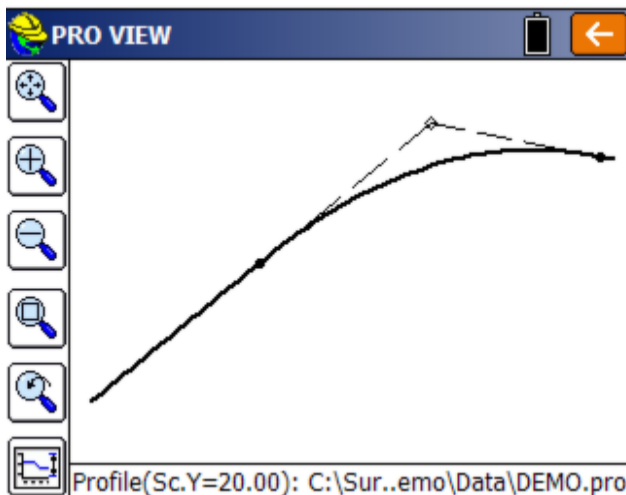

If you want to change the display scale, click the icon in the lower left corner. The dialog shown below will appear. Change the scale and tap **OK**.

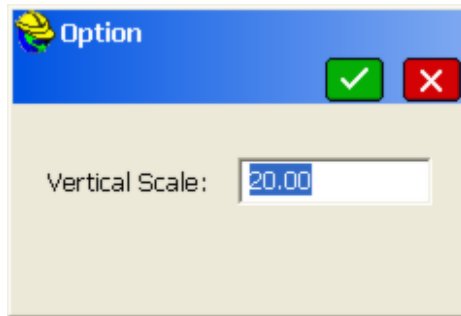

Template Editor

Templates for roads, levees, ditches and other earthwork can be created in Carlson Software products such as Carlson Civil or Carlson Roads, or alternately they can be entered in the field using **Input/Edit Template**. These templates can then be used in Carlson SurvCE in the **Stake Slope** command, where the template is one of the design files for slope staking, along with the centerline and the profile. Templates are also used in **Stake Road** (for staking those portions of the road from left shoulder to right shoulder) and for **Elevation Difference** by Road Design Files. Templates can be reviewed graphically using the command **Draw Template**. Templates are not necessary for the command **Stake Offset**, found on the SURVEY tab. In Offset Stakeout, road or other cross slopes from centerline are entered within the command itself.

Currently, SurvCE uses only templates created in Carlson Civil and Carlson Roads or entered directly within SurvCE using the command **Template Editor**. Every point on a template has an ID such as "EP" and "SH" or "CB1". Templates in SurvCE have only one surface—the surface you are staking. To stake out a subgrade, you could enter the surface grade information, then use a vertical offset in **Stake Road** or enter the subgrade surface directly as a template.

After selecting **Template Editor**, you are presented immediately with the input dialog shown in the figure below. If an existing template is loaded (based on the last template used), you can clear the screen by clicking the clear icon (eraser) in the upper right.

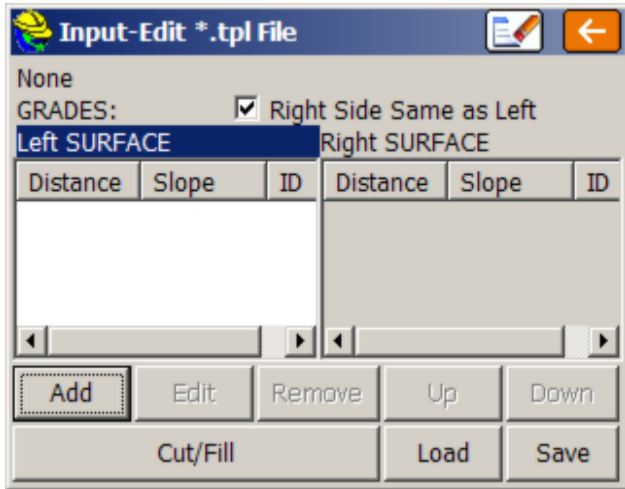

Template grades are entered top to bottom, and extend out from the middle position of the template. If you are dealing with a symmetrical template, keep the **Right Side Same as Left** option enabled. This will reduce entries by half. Otherwise, you must select the appropriate side and use **Add** to add entries, or **Edit** to revise. One trick, if you have non-symmetrical grades, is to keep **Right Side Same as Left** on and enter the symmetrical portion (perhaps the pavement lanes and first shoulder lane), then when you get to the outside shoulder or other lane where one side is different than the other, disable **Right Side Same as Left** and complete the non-symmetrical portion of the template. With the **Right Side Same as Left** turned off, you can click the words **Left SURFACE** or **Right SURFACE** and the left or right columns become active for editing. Alternatively, you may simply click into the items in the columns and edit or add.

In the curb-and-gutter template shown below, the **Add** option is used to enter the grade breaks from centerline out to the back of shoulder.

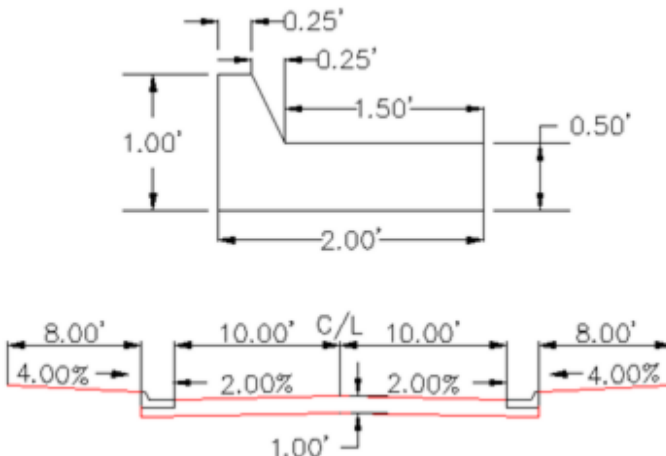

Since templates used in Slope Staking help define all grades into the centerline from the slope stake, it makes sense to focus on the subgrades that are built by the dozer, motor grader or trimmer. Thus, despite all the surface grades involved, there are only three distinct grades in this example curb and gutter template between centerline and the pivot point of the cut and fill slopes: 12.00 at -2% (subgrade at back of curb), 0.01 horizontal and 1 vertical, and 8.00 at 4%. For the **Vertical** method, some positive horizontal distances must be entered, such as 0.01 or 0.001. By pressing **Add** in the dialog, we can enter the first two grades.

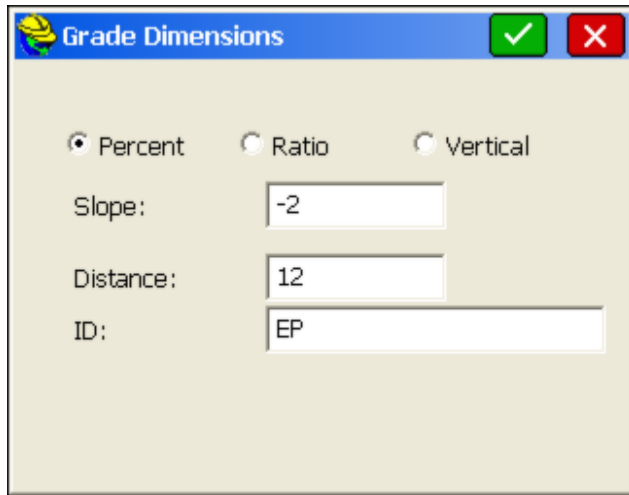

The dialog box titled "Grade Dimensions" has a blue header with a yellow and blue icon on the left, a green checkmark icon, and a red X icon on the right. It contains three radio buttons: "Percent" (selected), "Ratio", and "Vertical". Below the radio buttons are three input fields: "Slope:" with the value "-2", "Distance:" with the value "12", and "ID:" with the value "EP".

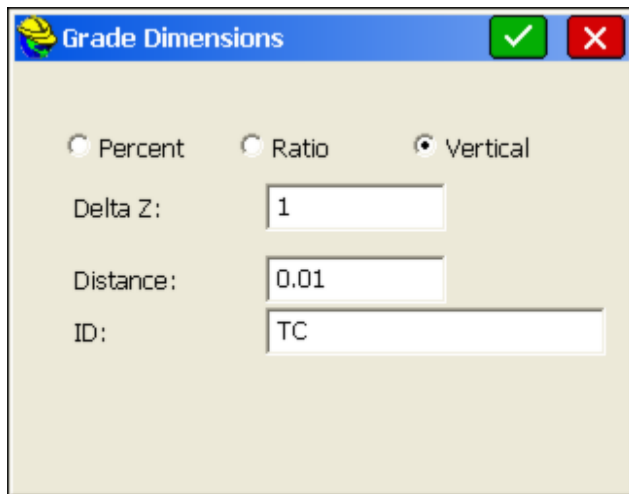

The dialog box titled "Grade Dimensions" has a blue header with a yellow and blue icon on the left, a green checkmark icon, and a red X icon on the right. It contains three radio buttons: "Percent", "Ratio", and "Vertical" (selected). Below the radio buttons are three input fields: "Delta Z:" with the value "1", "Distance:" with the value "0.01", and "ID:" with the value "TC".

Downhill slopes, going out from the middle of the template, are entered as negatives. Note that it is necessary to enter an ID for each break point in the template. This helps identify the description of the grade on the progressive slope stake report (e.g. from the outside going in, 8' at -4% to TC, 0.01' at -1 vertical to EP, 12' at 2% to CL). The shoulder slope going out (8' at 4%) is entered similarly, as above. The **Input-Edit Template** dialog now appears.

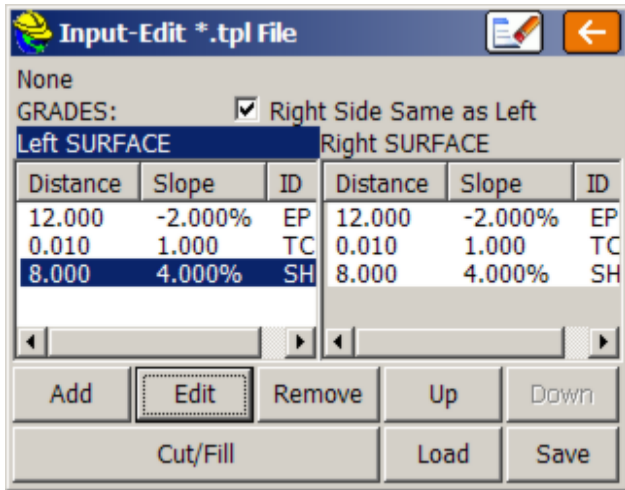

You can press **Save** any time to save your work. Here the template has been saved and named “curb.” Now it is time to enter the Cut and Fill slopes, which are used in slope staking. If the cut slope is 3:1, but the fill slope is 4:1, you would select Cut/Fill above and enter as shown. Distinct left side and right side cut and fill slopes can be defined. After entry of the cut and fill slopes, press **OK** or **Enter** to return to the main **Template Editor** dialog, and press **Save**. Templates can be drawn using the command **Draw Template**.

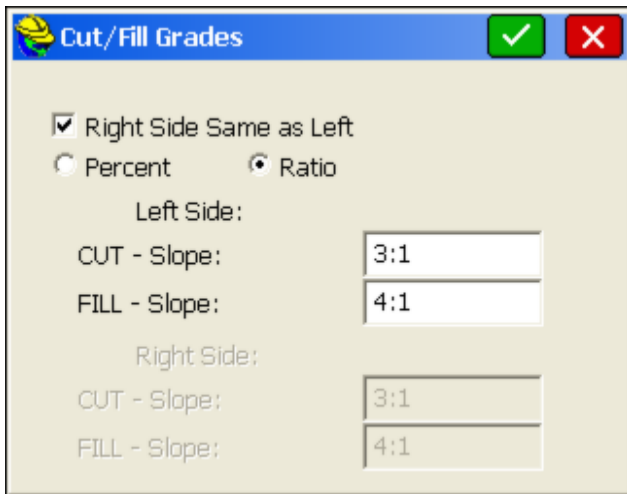

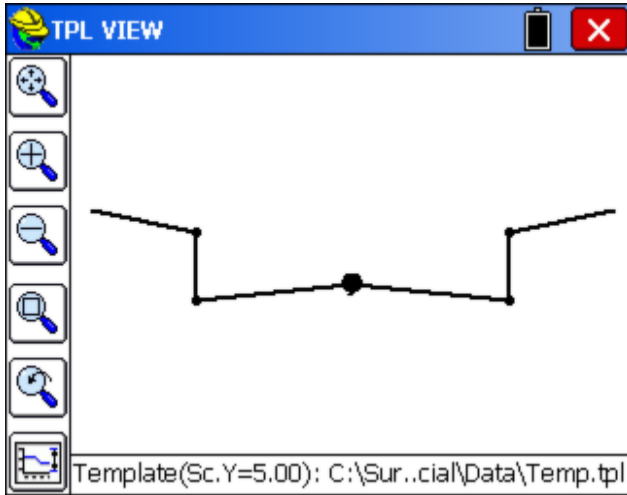

For highway projects or subdivision roads with cut slopes down to a ditch line, four template definitions may be necessary for slope staking: (1) Cut Left, Fill Right, (2) Cut Left, Cut Right, (3) Fill Left, Cut Right, (4) Fill Left, Fill Right. The appropriate template can then be used for any condition. Shown below is the Cut Left, Fill Right for a 2-slope (pavement and shoulder) road. The last slope in each column acts as the "pivot point" for the slope stake calculation. The fill slope is set at 4:1 and the cut slope at 3:1.

Left SURFACE			Right SURFACE		
Distance	Slope	ID	Distance	Slope	ID
12.000	-2.000%	EP	12.000	-2.000%	EP
8.000	-4.000%	GB	8.000	-4.000%	GB
12.000	-3.000:1	BD			

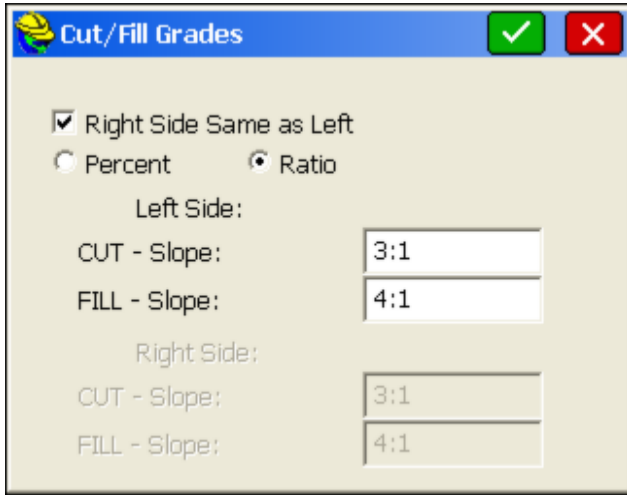

Using this template, cut slopes on the left side of the road will find the pivot at the base of ditch, while fill slopes on the right side of the road will pivot from the edge of shoulder.

Draw Template

The **Draw Template** command will draw the selected template on the screen. All the zooming commands [Zoom In, Zoom Out, Zoom Window, Zoom Previous and Pan] are available to you in the Draw Template command. Tap the **Menu** button to exit this command. The figure below illustrates this command using the “demo.tpl” template.

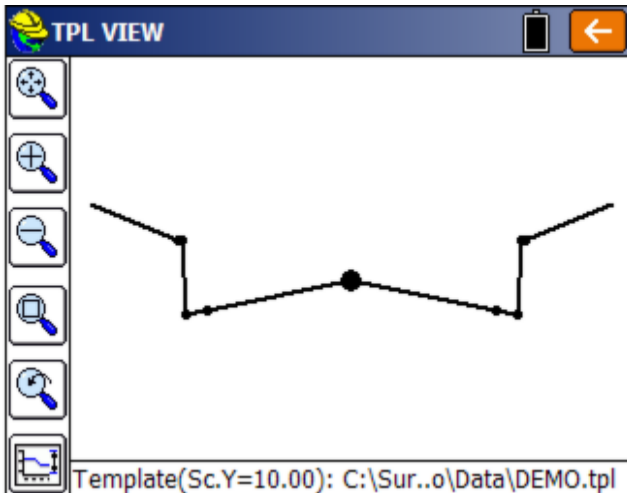

Utilities

Road Utilities includes necessary routines to convert centerlines, profiles and

cross sections from other formats to the formats used by SurvCE. SurvCE uses ASCII file formats for centerlines (“.cl” files), profiles (“.pro” files) and cross sections (“.sct” files). These same formats are used by other Carlson products such as Carlson Civil (formerly SurvCADD), Carlson Survey, Takeoff and Construction.

Road Utilities will also scale up or down centerlines and profiles, usually to convert between metric and English units. In addition, Road Utilities includes a command for entering a superelevation file (“.sup”). This file can serve as an optional input file and react with templates in commands such as **Stake Road**, **Slope Staking** and **Elevation Difference**. Road Utilities has an option for a Template Series file (“.tsf” file). This file will transition from one template to another automatically between designated stations, as long as the templates share identical IDs. The Template Series file can be substituted for a standard template file in **Slope Staking** and **Stake Road**, wherever design files are applied. Finally, a "Template Grade Table" can be entered in Road Utilities, which designates slopes and offsets that apply left and right of centerline for any road segment, between which a proportional grade and lane width transition is calculated. Template Series files and Template Grade Tables are alternate methods of transitioning roads of variable width or slope and should not be used in combination in the same station range.

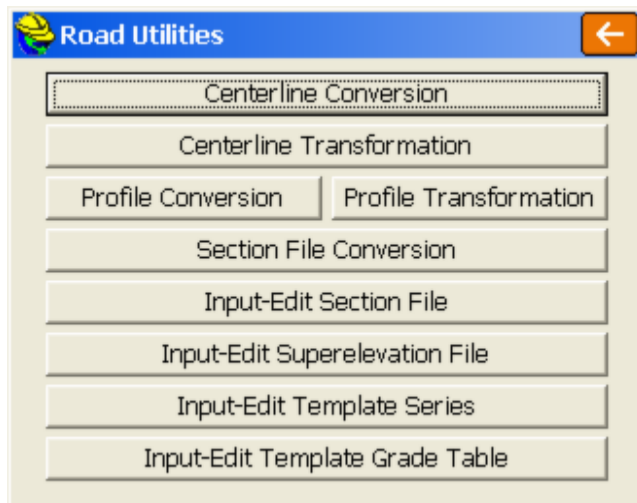

File Conversion and LandXML: The LandXML file format is becoming an encouraged standard of many departments of transportation (DOTs). This standard is also recommended by Autodesk, Bentley and Carlson. LandXML files have an “.xml” extension and may contain multiple road design files including centerlines, profiles, and cross sections. The “header” lines within the “.xml” file will indicate what design files are included. In some cases, several files of the same type, such as three or four centerlines or profiles, may appear in the same LandXML file. As more and more software companies offer LandXML file output, this file type may become the preferred form of data exchange. Be aware that each company tends to implement the LandXML format in slightly

different ways, much like DXF files for drawing data exchange were sometimes slightly different in format between Autodesk and Microstation, or from release to release. Therefore, if a LandXML file containing centerlines, profiles or cross section files fails to convert, it is recommended that the file be emailed to Carlson Software so changes can be made in SurvCE to enable conversion. LandXML is an evolving format that is likely to solidify in the near future.

Centerline Conversion

This command converts horizontal alignment files to and from the Carlson centerline format (*.CL). Supported file types include:

- ASCII Inroads (.ASC)
- ASCII LDD (.TXT)
- Caice (.KCP)
- CLIP (.PLA)
- Geopak (.OSD)
- ISPOL (.ALI)
- LandXML (.XML)
- Leica (.GSI)
- MOSS (.INP)
- SDMS (.ALI)
- SDR (.SDR)
- SMI Chain (.CH)
- TDS (.RD5)
- Terramodel/Geodimeter (.RLN, .ALN and .ARE formats)

The SurvCE format has a “.CL” extension. These source files can be loaded into SurvCE using **Data Transfer**, located in the File menu options. When performing the conversion, and selecting a particular format, SurvCE automatically looks for the corresponding file extension.

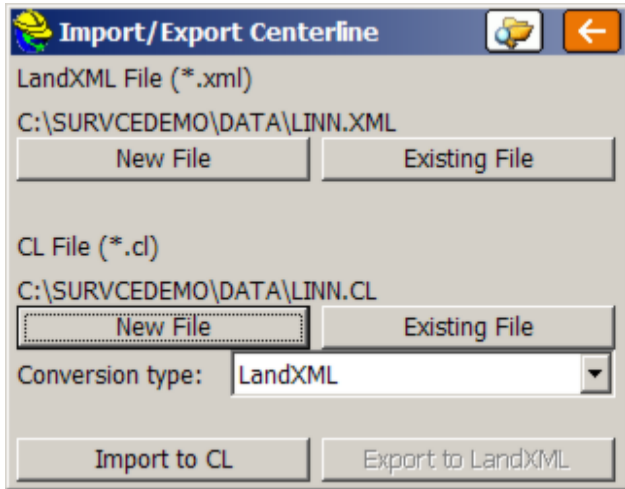

Report Icon for LandXML Files: If you are importing a LandXML file specifically, you can click the Report icon left of the "Return" icon in the upper right of the dialog, and review the source of the data as shown:

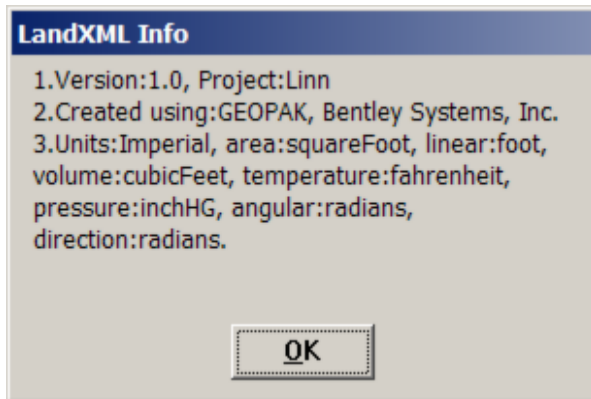

Conversion: Clicking **Existing File** in the upper right (in the Land XML section) will load the file, and clicking **Select New** under the CL File section will save the centerline file in the correct format for use in SurvCE. To convert in the opposite direction, select **Existing File** under the CL section to recall a SurvCE centerline file, and then click **New File** in the upper left (under LandXML file) to save it back to a LandXML file, for use in other software.

For file types in which both Import and Export options are available, the conversion procedure forms a “criss-cross”: You bring the files into SurvCE by going upper right (“Existing”) to lower left (“Select New”). You send the files back to the “non-SurvCE” format by going lower right (“Select Existing”) to upper left “New”.

When the files have been selected, the appropriate action is highlighted below,

"Import to CL" or "Export to <type>". When the process is completed, the program announces "Process Done," and you are free to move on to the next command. Most formats only convert to SurvCE and not back again, and therefore only have "one-way" dialogs. These include ASCII-Inroads, ASCII-LDD, Geopak, Moss, TDS and Terramodel/Geodimeter.

Importing TDS RD5 Files

Importing TDS RD5 Files: If TDS is selected, centerlines can be converted one-way to SurvCE centerlines (centerline files CANNOT be converted back to TDS files). It is important to note that the TDS RD5 file is a dual centerline and profile file. Because the TDS RD5 file does not display the starting station, an extra dialog will appear requesting starting coordinates (which can be recalled from a point) and a starting station.

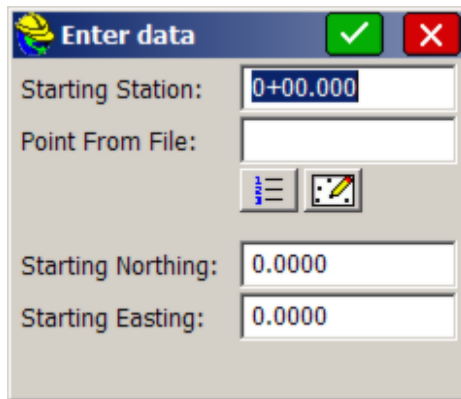

Verify the Conversion

It is recommended that after converting centerlines, profiles or cross section files to SurvCE format, you go to the Editor and Draw options for these file types and review the data to verify that the correct file was converted and that the conversion was successful. So, for example, after converting a centerline from Inroads format to SurvCE ".cl" format, go directly to **Centerline Editor** in the Roads menu and verify the data.

Recognizing File Formats

For reference, portions of four of the file types are shown below, as they might display in a Text Editor. The LandXML, SurvCE and SDR examples all reference the file DOT1.CL. These displays may help you recognize these file types in the future. The new LandXML format, endorsed by many Departments of Transportation in the United States, may soon become the standard in the future for internet transfer of roading and other types of design files.

LandXML	<pre> <CoordGeom> <Line length="848.64000000" dir="2.38921515" > <Start>10000.00000000 10000.00000000</Start> <End>10579.94056914 9380.43661675</End> </Line> <Curve rot="ccw" chord="1914.99460706" crvType= <Start>10579.94056914 9380.43661675</Start> <Center>2213.99512832 1549.51682467</Center> <End>11767.20701020 7877.90450628</End> </Curve> <Line length="1947.71000000" dir="2.55652497" > </pre>
SurvCE	<pre> 0,10078.69000,L,10000.00000000,10000.00000000 0,10927.33000,L,10579.94056914,9380.43661675 0,10927.33000,PC,10579.94056914,9380.43661675 0,9.351012766,R,2213.99512832,1549.51682467 0,12844.56000,PT,11767.20701020,7877.90450628 0,14792.27000,L,12842.84117284,6254.14793824 0,14792.27000,PC,12842.84117284,6254.14793824 0,7.125600000,R,3289.62929108,-74.23974329 0,16235.38163,PT,13562.04766716,5004.12304528 0,24641.89003,L,17287.56502100,-2531.78459252 0,24641.89003,TS,17287.56502100,-2531.78459252 </pre>
SDR	<pre> 00NMSDR33 V04-04.24 Jul-29-99 14:49 122211 28KIDOT1 1 06NM1.00000000 29NM10078.6900 313.108056 10000.0000 30NM10579.9406 9380.4366 32NM1917.2300 -11459.1600 30NM11767.2070 7877.9045 30NM12842.8412 6254.1479 32NM1443.1116 -11459.1600 30NM13562.0477 5004.1230 30NM17287.5650 -2531.7846 </pre>
TDS	<pre> HR+++++ HL,77.0204,151.834 HC,-1.0,300.0,114.436,L HL,-1.0,128.892 HC,-1.0,800.0,846.144,R VR+++++ VG,47.02,0.000000 VG,215.48,5.000000 VC,75.0,5.000000,8.000000 VG,25.0,8.000000 VC,75.0,8.000000,9.430000 </pre>

Centerline Transformation

This routine is designed primarily to convert centerline data from Metric to Survey Feet or from Survey Feet to Metric. The image below shows the dialog and scale factor when converting from Metric to Survey Feet.

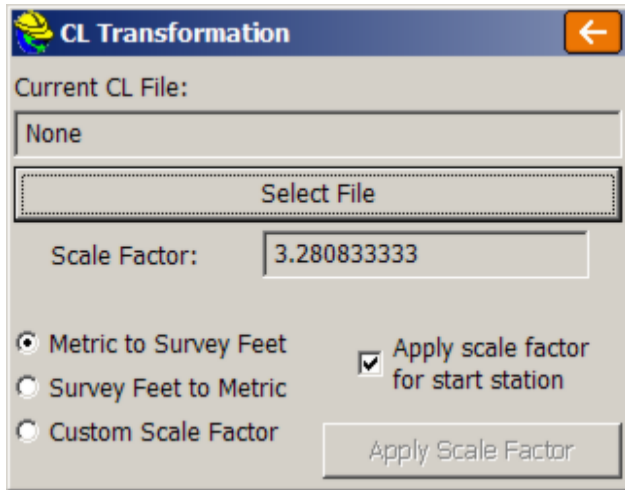

Apply scale factor for start station: If this option is enabled then the starting station will be converted using the scale factor. For example, a start station of 1000 would become 3280.833. If disabled, the start station would remain at 1000. If the goal is to change the starting station by a certain amount unrelated to the scale factor, then you must use **Input-Edit Centerline** and enter a new start station in the initial dialog. This will automatically translate all stations in the centerline by the appropriate amount.

When **Apply Scale Factor for start station** is enabled, the centerline is adjusted by the scale factor, after a confirming warning screen.

Profile Conversion

This command converts vertical alignments to and from the Carlson profile format (*.PRO). Supported file types include:

- ASCII-LDD (.TXT)
- Caice (.KCP)
- CLIP (.ALZ)
- ISPOL (.RAS)
- LandXML (.XML)
- Leica (.GSI)
- MOSS (.INP)
- **SDMS (.PRO)**
- SDR (.SDR)
- **SMI (.CH)**
- TDS (.RD5)
- Terramodel/Geodimeter (.RLN, .ALN and .ARE)

The SurvCE format has a .PRO extension. These source files can be loaded into SurvCE using the **Data Transfer** feature in the FILE tab. The conversion screen is similar to Centerline Conversion, with the characteristic “criss-cross” logic for 2-way conversion (LandXML and Leica) and one-way import only conversion for the other options.



The SurvCE Profile File Format: It should be noted that of all the SurvCE file types that are ASCII and therefore viewable in standard text editors, the profile (.pro) file has the simplest format. The format is station, elevation, length of vertical curve, and description for road profiles. For example, the Demo.pro file that is typically provided with the software has the following four lines (which can be viewed in Notepad):

```
0.0000, 997.0000 , 0.0000,  
200.0000, 1005.0000 , 200.0000, (200 foot vertical curve length)  
308.0000, 1003.9200 , 0.0000,  
0.0, 0.0, 0.0 (this is an “end-profile” line)
```

Profile files can be created from within SurvCE, but are simple enough to be hand-entered using a text editor as well. Unequal vertical curve lengths can be entered in the form 150-50, indicating 150 units to the point of vertical intersection and 50 units to the point of vertical tangency. Other ASCII file types, such as centerlines, can be deciphered, but are generally of a more complicated design and are best created using the editors provided within SurvCE.

Profile Transformation

Like Centerline Transformation, this routine is primarily used to scale a profile up or down to go from Survey Feet to Metric or from Metric to Survey Feet.

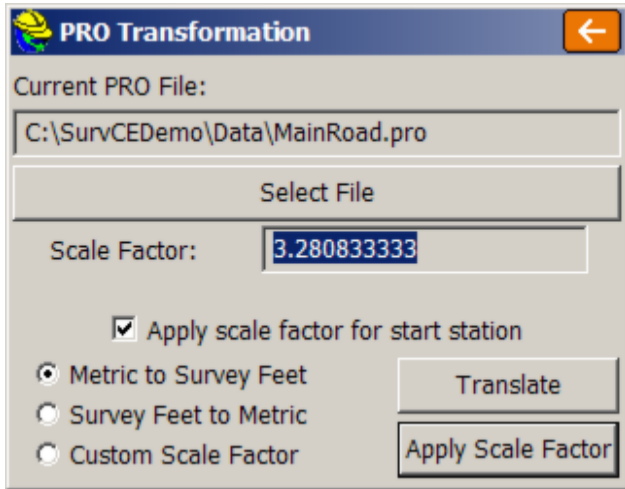

Unlike **Centerline Transformation**, **Profile Transformation** can directly translate the profile up or down. You can also scale the profile stationing and elevations. If you want to apply a translation to selected stations, tap the **Translate** button. The Translate option leads to its own dialog of entries, which allows you to translate both the stationing and the elevations, as shown below. In this way, you can make the starting station 1000, or raise the entire profile 15 feet or meters.

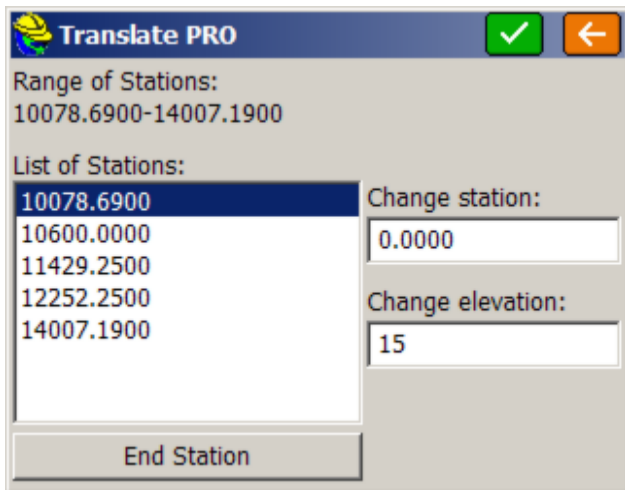

By default, the entire range of stations is selected. If you wish to only translate a range, highlight the beginning station, then click **End Station** and highlight the end station. Next enter the amount to translate in the **Change Station** box. You may also translate the elevation using the **Change Elevation** box. Tap **OK** when you are finished.

Section File Conversion

This command converts section files to and from the Carlson section file format (*.SCT). Supported file types include:

- Caice (.FFF)
- CLIP (.TRV)
- Geopak (.XRS, .XSR, .SOE & .TXT)
- IGRDS (.LIS, .RDS & .TXT)
- **Inroads (.TXT)**
- ISPOL (.SC1 & .RAS)
- LandXML (.XML)
- Columnar Text (.TXT, CSV & .ASC)
- Terramodel/Geodimeter (.XSC)

The SurvCE format is “.SCT”. Section files are used for **Stake Slope, Stake Road** and **Elevation Difference**. **Cross Section Survey** also has the ability to output section files. TDS will store cross sections in an RD5 format that behave as a series of templates, following "rules" for slopes coming from the design profile grade. You can import TDS-style cross sections using **Input-Edit Template Series** within Road Utilities, and for "Files of Type", select TDS.

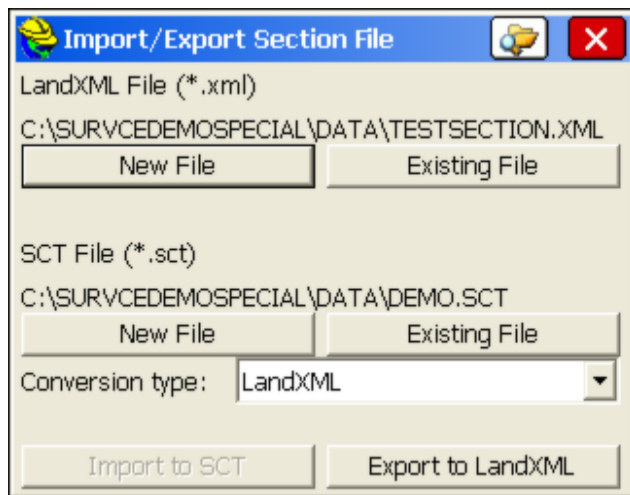

Note that if you select **XML Info** at the top of the screen, you'll see some of the "header" information associated with the XML file to be exported or imported.

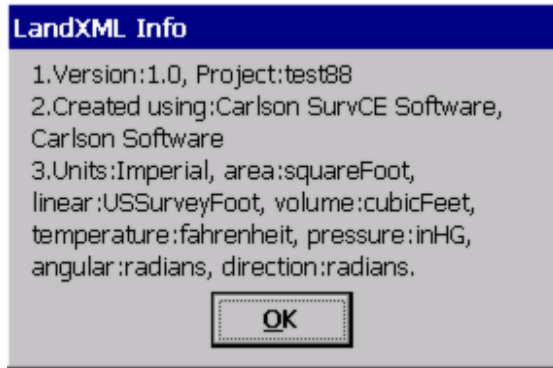

To export to LandXML, you need to load a LandXML file that already contains a centerline covering all or part of the station range in the SCT cross section file. Otherwise, you will see an error message.

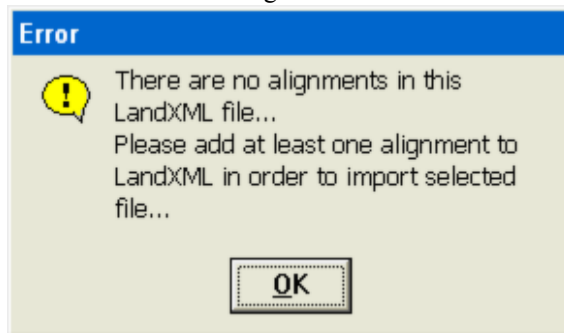

Despite the message, you can add the horizontal alignment portion to the LandXML file after creating the file with sections only. However, if you first create a LandXML file containing one or more alignments, then choose that existing LandXML file to export to, you can select among those centerline alignments when making the cross section file.

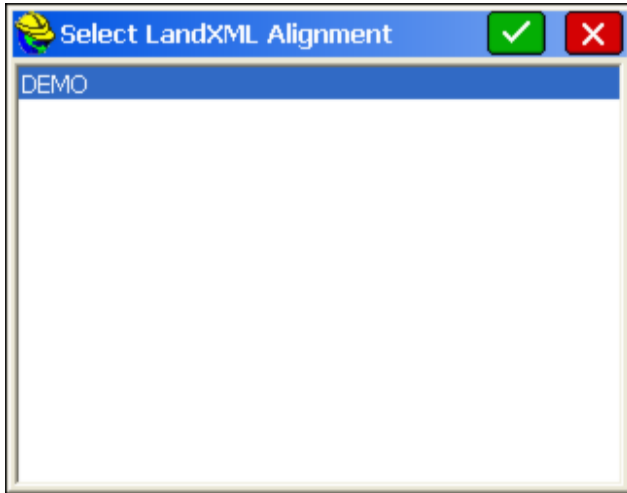

Section files in SurvCE can contain descriptions useful for reference in other routines such as **Stake Road**. If descriptions are found in the source section file, they will be captured by the import process into the “.set” file for use in SurvCE.

Pipes running longitudinally along horizontal alignments can be imported in the form of cross sections using the Columnar Text form. The example below shows the layout of the pipe format that is recognized by SurvCE.

```
STA,Offset,FL elev.,Link - ID,Link - Library Item,Type
13+00.00,52.13,22.32,NP-26,18" RCP,T
14+00.00,-47.61,22.08,NP-1,18" CMP,T
14+00.00,49.63,22.02,NP-26,18" RCP,T
15+00.00,-39.58,21.78,NP-1,18" CMP,T
15+00.00,49.15,21.73,NP-27,18" RCP,T
16+00.00,-38.00,20.22,NP-3,24" RCP,T
16+00.00,48.92,21.45,NP-28,18" RCP,T
```

Within Stake Road, Section Method, the pipes can then be loaded as a cross section file and the pipe inverts can be staked in the same way that road cross section points can be staked. The pipe format is recognized and the pipes display with their correct diameter shown. Note the ability of the program to display the pipe size, captured as the 5th field in the ASCII file (above):

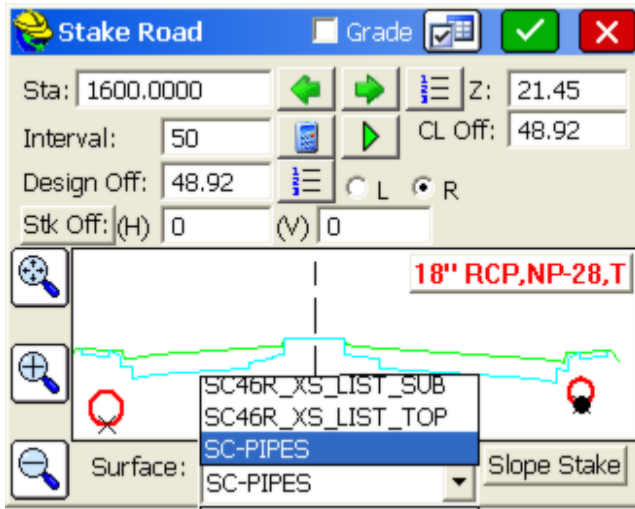

Input-Edit Section File

This routine is a convenient cross section editor. It can be used for entering new sets of cross sections or for editing and reviewing an existing set of cross sections. One nice application is **Slope Staking**. If you know the left and right “pivot points” on stations to be slope staked, you can enter very simple, two-point cross sections consisting of the left pivot offset and elevation, and the right pivot offset and elevation. Then, without taking a cheat sheet into the field, you can slope stake by cross section method, and the program will seek these pivot points, and even interpolate the correct pivot points between entered cross sections.

A better approach would be to include all break points in the sections from pivot left to pivot right, along with descriptions. Then Slope Staking will report the progressive information to grade each point from the catch all the way into centerline. This “section-based slope staking” is a cross between user-defined (where you need the cheat-sheet!) and design files, where the pivot offsets and elevations are taken from the pivot points in the template as they react with the profile and superelevation files. Sections used in **Stake Road** should be complete cross section files, with all offsets, to enable precise, interpolated stakeout within the left-to-right range of the sections, on station, or at interpolated stations.

The Input-Edit Section File routine begins by prompting for a cross section file name. If you wish to start a new cross section file, just enter a new name.

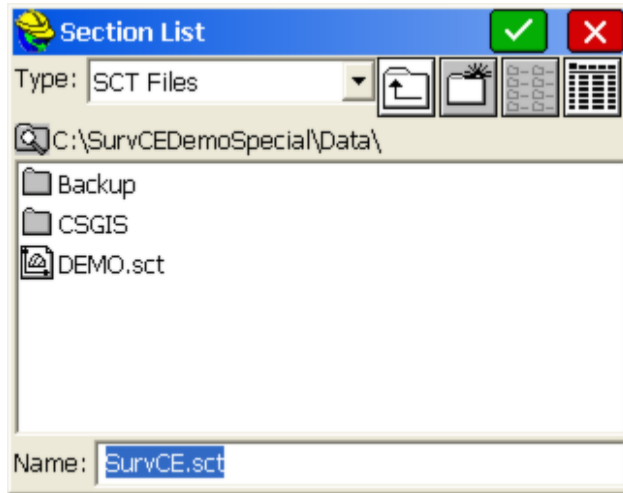

If you choose to select an existing cross section file, such as DEMO.sct, after selecting the file, you will see the “Section List” dialog.

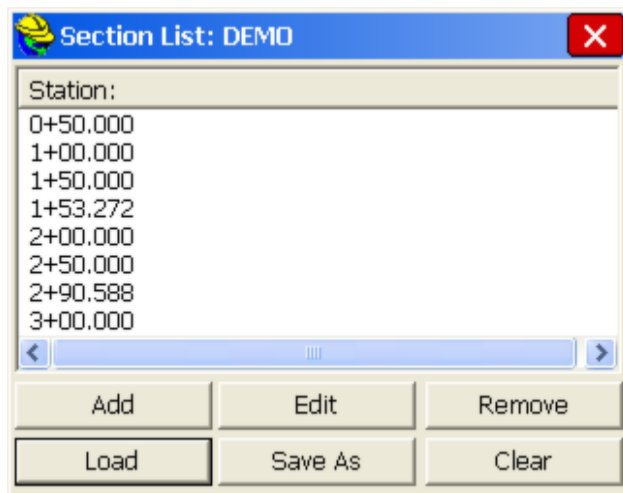

From this dialog, you can **Add** stations, **Edit** existing stations, **Remove** stations, **Load** entire new cross section files, **Save As** (to save your changes to the current loaded file or to a new cross section file), and **Clear** the list of stations (not recommended unless you want to start from scratch). Select **Edit** to review a station.

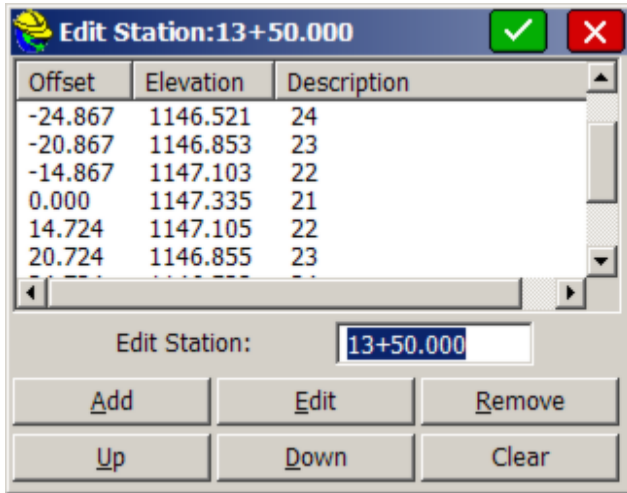

In this dialog, you can **Add**, **Edit**, **Remove**, **Rearrange**, or **Clear** existing offsets and elevations. Note that cross section offsets are negative for left of centerline and positive for right of centerline, and can have descriptions such as SH, EOP, CL, Ditch, 21, 22, 23, etc. These descriptions, where they exist, are potentially useful for description-based interpolation between stations, as applied **Stake Road**. If you want to add an offset at -42.867 called RP, click **Add**. You don't have to highlight the correct offset to add above—the software will sort and place the new entry appropriately.

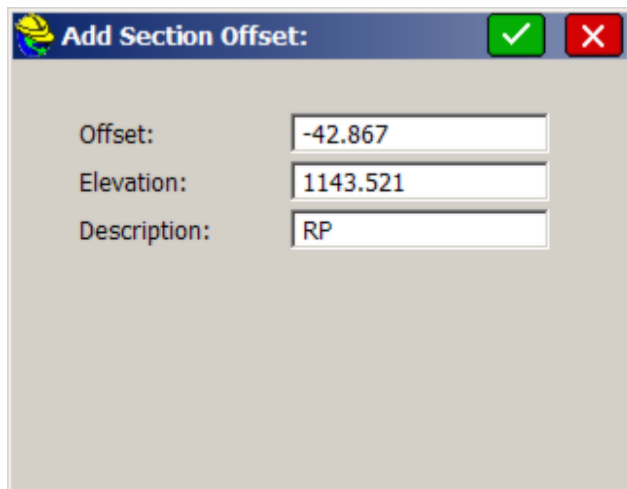

When you click **OK**, your new entry will be in the list.

The **Edit** box leads to the same entry dialog as **Add**. **Remove** will provide a warning and then delete the highlighted offset and elevation. Up and Down should not be used unless a file conversion led to out-of-order listing of offsets and elevations. When you click **OK** from the station edit dialog, you can save the

revised cross section file back in the section list dialog.

Input-Edit Superelevation

Roads can contain one or more curves, and each curve can have its own superelevation data. This data includes start station for super transition, station for full super, percent of full super, station for end full super, and station for ending the super transition back to normal crown. In SurvCE, each superelevation data set for each curve would be entered as a “line” of superelevation data in the “.sup” file.

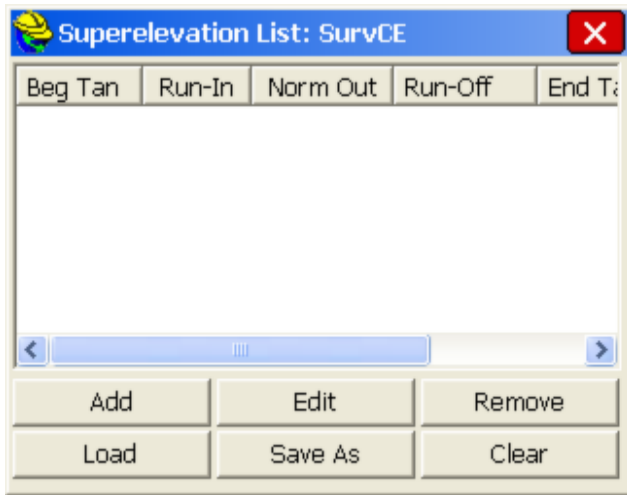

If we had two curves, both with superelevation, then we would do two **Adds** using this dialog. Let’s say, for simplicity, that we have a road with a 2% “normal crown” which has one curve to the left followed by one curve to the right, with the following information:

	Curve 1	Curve 2
Start Super Pivot	Sta: 100	Sta: 2200
Full Super	Sta: 600	Sta: 2500
Full Super %:	3% Left	4% Right
End Super:	Sta: 1400	Sta: 3500
End Super Pivot:	Sta: 1900	Sta: 3800

The first curve to the left goes through three stages as it pivots into full super: (1) the right side pivots to “flat”, (2) the right side pivots to “reverse crown”, where the slope is the same across the template and (3) both the right and left sides pivot from the hinge point (centerline) into full super. All of these key pivot points are entered in the superelevation dialog.

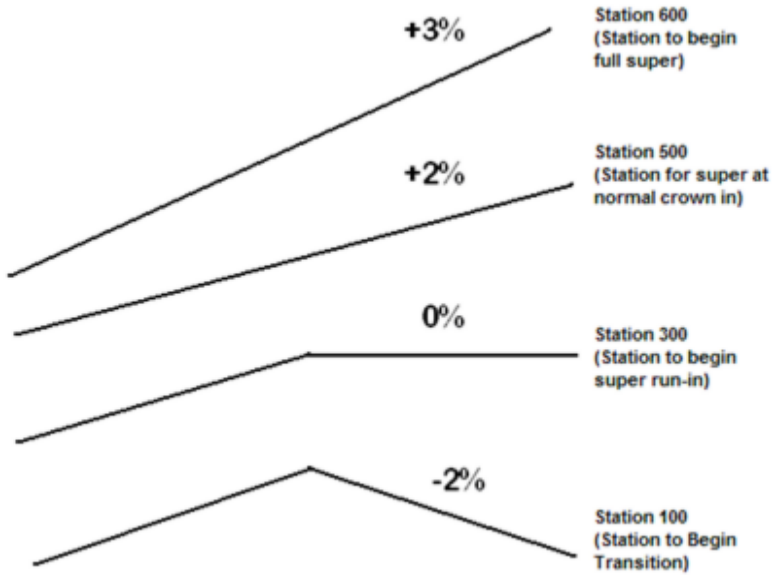

You enter all these key stations (begin, flat outside lane, reverse crown, full super) both going up to full super and transitioning back down to normal crown. Recognizing that the normal crown of -2% transitions from station 100 through a slope of 5%, the transition is 1% per 100 feet, assuming an even rate of transition. Therefore, a “flat” outside slope occurs at station 300, reverse crown at station 500 and full super at station 600, as shown. You will need to compute these stations in advance. These intermediate stations are entered in the superelevation dialog to allow for different rates of transition from normal crown to flat to reverse crown to full super. Normally, the rates of transition are consistent. Note that super left or right is always entered as a positive percent slope—the road centerline curve direction will control the direction of pivot. You are now ready to click **Add** and enter in Curve 1.

Add Superelevation:		✓	✗
Station to begin transition:	100		
Station to begin super run-in:	300		
Station for super at normal crown in:	500		
Max slope of super full, in percent:	3		
Station to begin full super:	600		
Station to end full super:	1400		
Station for super at normal crown out:	1500		
Station to end super run-off:	1700		
Station to end transition:	1900		

When you click **OK**, the first line of the superelevation dialog is filled in. Curve 1 is complete. Next, we enter Curve 2 as follows, using similar logic.

Add Superelevation:

Station to begin transition: 2200

Station to begin super run-in: 2300

Station for super at normal crown in: 2400

Max slope of super full, in percent: 4

Station to begin full super: 2500

Station to end full super: 3500

Station for super at normal crown out: 3600

Station to end super run-off: 3700

Station to end transition: 3800

When **OK** is clicked, the two curves are complete and the summary dialog appears. There is one line (or row) for each curve.

Note: If any of the columns are too narrow to display all the text, you can “grip” the vertical line separating columns, much like in programs such as Excel, and make the column wider.

Superelevation List: SurvCE

Beg Tan	Run-In	Norm Out	Run-Off	End T:
100.00	300.00	1500.00	1700.00	1900.00
2200.00	2300.00	3600.00	3700.00	3800.00

Buttons: Add, Edit, Remove, Load, Save As, Clear

The superelevation file is one of the optional “roading” or “design” files in **Stake Slope, Stake Road and Elevation Difference**. After a superelevation file has been entered and saved, it will appear as the default superelevation file in all of these commands, unless removed from the design file list by the user.

Input-Edit Template Series

SurvCE allows for two types of transitioning: (1) a single template can transition by being “acted upon” by template transition files (made in Carlson Roads, Topsite, Leica Site Manager or Carlson Civil) and superelevation files, or (2) a template series file can transition between several templates sharing identical IDs, but having different slopes and widths between ID points within the templates.

You can load an existing TDS template series file, in the RD5 format, by clicking Load, then clicking the down arrow for Type of File, and selecting TDS format. TDS templates always have IDs and the same number of template points per cross section, so once imported, they behave exactly like SurvCE-defined templates. Using the Draw Template option, any particular template in a template series file can be selected and displayed as shown:

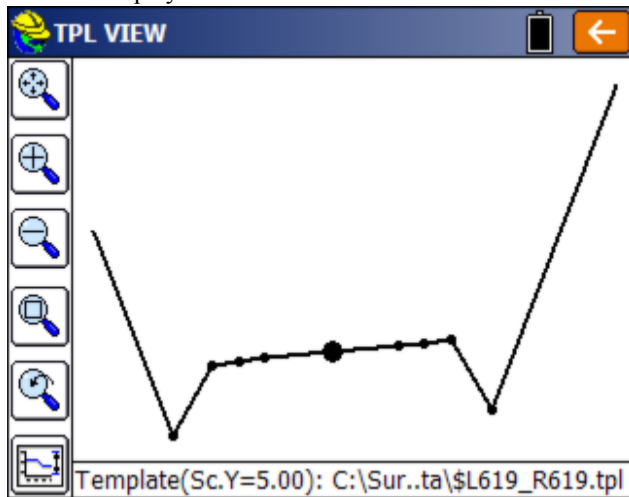

The Template Series approach can even be used to transition from normal crown to superelevation, avoiding the need to use superelevation files. The Template Series approach is commonly used to expand the width of a lane to accommodate, for example, a passing lane. Since template IDs must match, if a “special slope” lane “appears” for a certain station range, then the Template Series approach can still be used as long as you add the extra ID point (e.g. EP2) to the normal template, perhaps making that point 0.001 units in dimension initially. In the second, transitional template, the EP2 lane can have the full width of 3.5 meters or 12 feet or whatever applies. If the transition starts at station 500 and ends at station 600, EP2, will be 1.75 meters or 6 feet or exactly half the full dimension at station 550.

Starting with the demo.tpl file, with a 10' lane to ID “EP” followed by a 6' shoulder lane to ID “SH”, you can make another template called Road.tpl, with a 12' lane to “EP” and an 8' shoulder to “SH”. Note how we have made sure to use the same ID for the road lane (“EP”) and the shoulder lane (“SH”).

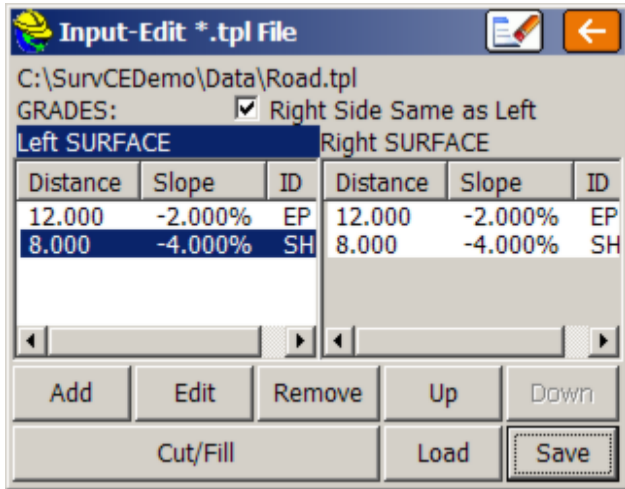

If the demo.tpl is used from station 0 to 500, and the Road.tpl is used from 600 to the end of the project at station 1000, then the entry process for a Template Series is as follows:

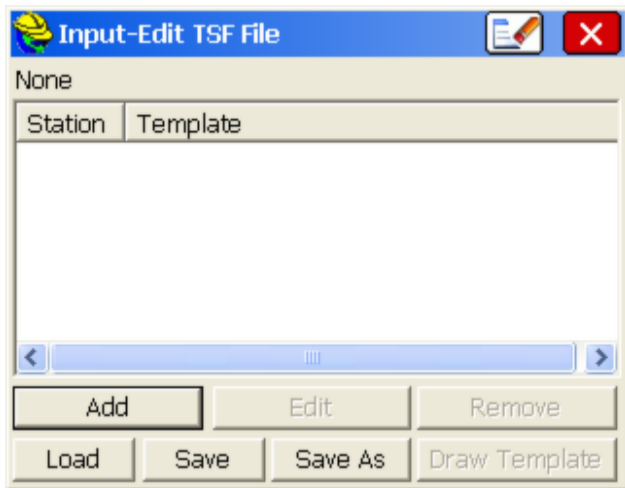

Click Add and you will obtain the next dialog.

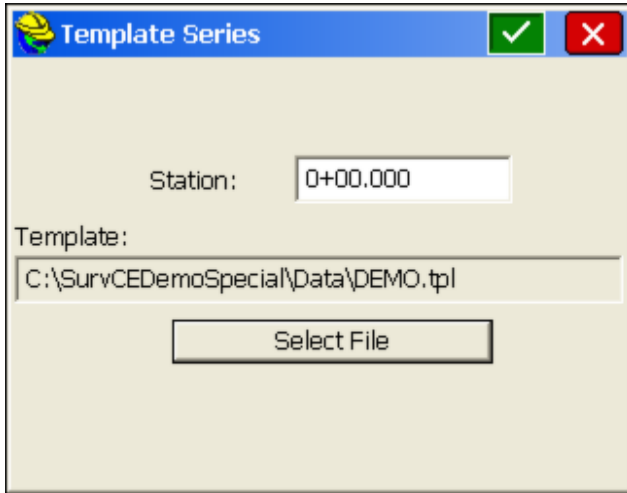

Choose Select File and pick the first template (demo.tpl). Click OK. Back in the main dialog, click Add again and specify the ending station for demo.tpl as station 500. Then click Add again and specify the first station for Road.tpl as station 600. You do not need to specify an end station, as Road.tpl will be used for the remainder of the project.

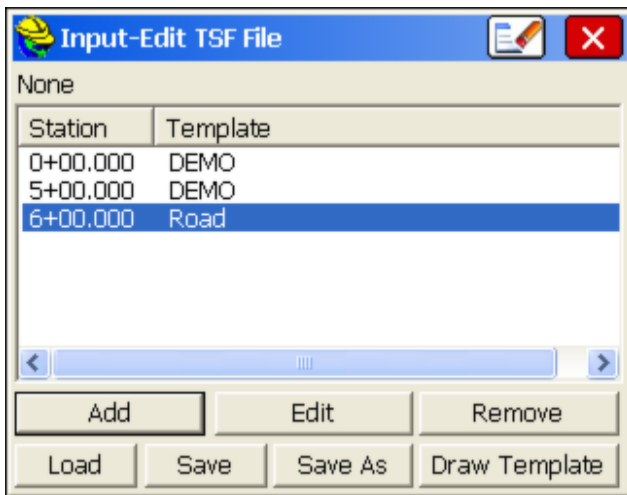

You then Save the Template Series File. When running **Stake Road**, **Stake Slope** or **Elevation Difference** by **Roading Design Files** and recalling a template file, you have the option to recall a Template Series File and process a set of transitioning templates.

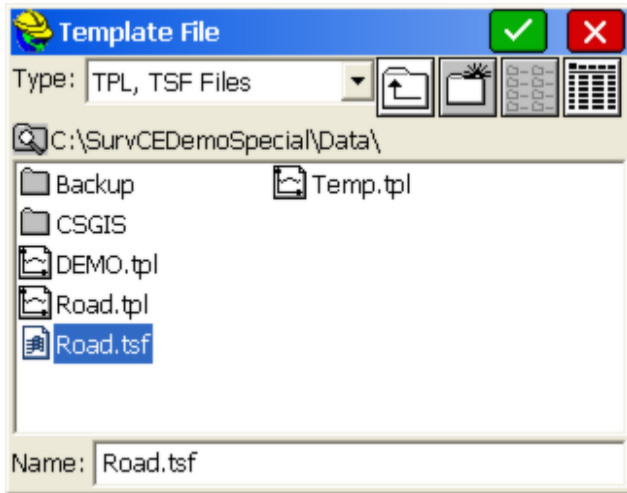

Input-Edit Template Grade Table

Very complex roads such as exit ramps, with widening and shrinking lane widths and slopes that do not follow a simple superelevation pattern but instead adapt to meet grades of intersecting roads, can be defined using the Template Grade Table feature. Although template series files can be used to model any road, the creation of multiple templates, including all lanes, can be a labor-intensive process compared to entering the precise slope and width for particular template ID points. These slopes and widths are often provided in tabular form in the design documents, so direct entry of the slope/width data, applied to the appropriate template ID or several IDs, is often the most efficient way to handle complex road conditions.

Consider a template that goes from the center of the road to SH and then to SH2. The second segment is always 8 feet dimension at a fixed slope. The first lane, from centerline, is paved and has variable width and slope. The template grade table is applied to the first lane, after which the normal template rules apply. After selecting the command, you name your new (or existing) template grade table, and then the template that it is associated with. This leads to the screen shown below:

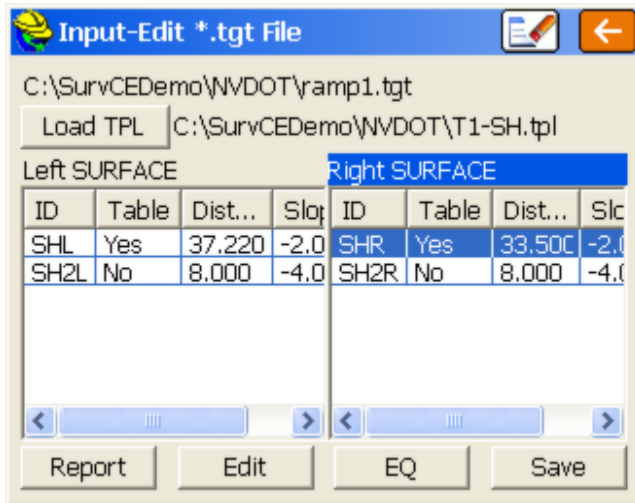

The normal slopes of -2% to the edge of pavement (inner edge of shoulder) and -4% to the outer edge of the shoulder would apply if the template behaved normally. But if you click Edit on the right shoulder, for example, you can enter station-based lane widths and slopes as shown below:

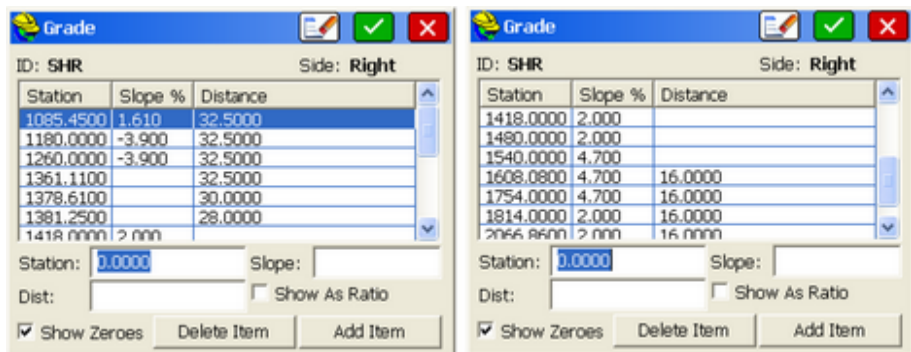

In this example, considering first slope, the road begins midway in transition, at slope 1.61% in a curve left, then transitions into a curve right with a slope of -3.9% at station 1180, greater than normal crown, holding this grade through station 1260. Then the road veers again to a curve left of 2% and holds that from station 1418 through 1480, after which it transitions to 4.7% at station 1540, holds that slope through 1754, and transitions back to a uniform cross slope of 2% at station 1814 where it remains through station 2066.86. Note that where no slope entry is entered (eg. at station 1361.11 through 1381.25), the program transitions proportionally between the last actual entries provided (1260 and 1418).

While the slope is following the instructions of the slope column, the road lane width adheres to the distance column. So if the right-side shoulder width is 32.5 feet through station 1361.1, you can enter that distance for all stations in that

range, or you could simply bracket the distance by entering 32.50 for station 1085.45 and 1361.11 and leave 1180 and 1260 blank for distance. Either way, it will compute correctly. Then for each station where a distinct distance is given in the plans, a new station entry is made, such as at 1378.61 (30') and 1381.25 (28'). If the road transitions from 28' to 16' between stations 1381.25 and 1608.08, then all stations used for slope in that range can be left blank for distance. For station 1608.08, the distance of 16' needs to be entered, to complete the distance transition, and the slope at 1608.08 can be entered (since it is known) or left blank. Either way, it will calculate correctly, since the 4.7% slope is governed by stations 1540 and 1754. Similarly, for the final stations 1754 through 2066.86, the known distance of 16' can be entered or left blank.

At station 1500, the right-side SHR lane is both in slope and in distance transition. The program will calculate this and you can review the slopes by using the Stake Road command, as shown below:

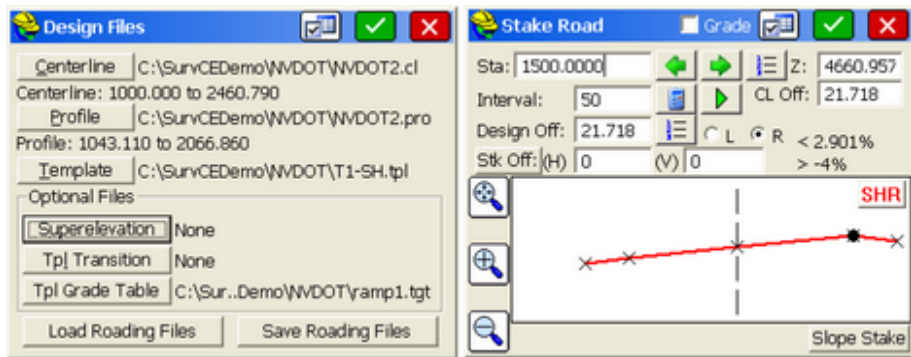

By clicking on the SHR ID point, the program displays the computed offset (21.718) and the computed slope in (2.901%) and slope out (-4%, per the standard template). A similar page of values was entered for the SHL ID point, leading to the uniform superelevated slope left to right. With the **Template Grade Table**, applied to as many template ID points as needed, any complex road can be defined. When running **Stake Road**, **Stake Slope** or **Elevation Difference** by **Roading Design Files** and recalling a template file, you have the option to use a **Template Grade Table** for precise modeling of complex roads.

Stake Slope

The **Stake Slope** command calculates and stakes out the location of the “catch point” where fill slopes or cut slopes contact the original ground. The command will also set offset stakes to the catch point and will produce a report of the slope stake information. The location of the slope stake is dependent on the position of the “pivot” point where the slope begins and on the slope itself (eg. 2:1, 3:1, 4:1, etc.). Slope stakes are typically used in highway work to locate the top of slope or top of cut. If design file information is available for the road template and profile, then the slope stake routine will calculate distance and offset information for all “break points” on the template from the slope stake itself back to the centerline. This also applies to slope staking conducted by section files, and descriptions

associated with the break points on templates and/or sections are identified by name in the slope stake report.

Note: Slope Staking can be conducted within the **Stake Slope** command from the fixed "pivot point" of the template, the end-points of cross sections, or the centerline points of a horizontal and vertical alignment (as for a ditch). Slope staking, however, can also be conducted directly within the command **Stake Road** from any picked pivot point on the template or cross section. One of the advantages of the **Stake Slope** command is the ability to obtain catch point information "real-time" using the "non-interval" method of walking parallel to centerline. **Stake Slope** will also automatically detect the ditch pivot point in cut scenarios using templates defined by Carlson Civil and Carlson Roads. Plus **Stake Slope** knows which side of the centerline you are on and slopes stakes automatically to that side. The main advantage of **Stake Road** is the ability to slope stake from any picked point going either Left or Right as specified, for "staged" or partial roadwork design, or for finding catch points towards the interior of the template (eg. central median). Stake Road also has a cross section view option (within the Helmut Help). All slope staking is improved if the instruction to the user is In-Out from centerline and Forward-Back along the axis of the centerline. For this reason, it is best to set the View Point within **FILE, Configure** to In-Out and Left-Right, but also click on "**Use Centerline for Reference Object**".

There are "rules" for slope staking. The slope stake is measured from a pivot point, which is user-entered, or starts at the centerline itself in "point-defined" alignments, or starts at the last template point before the cut or fills when templates are involved, or starts at the left and right end-points of sections when using section files. Note that in the command **Stake Road** (which works with both sections and templates), slope staking can be initiated from any desired point. This allows for slope staking of interior, central median catch points and slope staking of any side of an eventual divided highway, being built in stages. Slope staking can be interval based, or accomplished based on where you are standing right now, independent of station interval.

Although office plans may predict the position of the catch points, slope staking is necessary to accurately determine the catch points based on actual field conditions. Slope stakes are often set at an offset to the actual catch points, since stakes at the precise top of slope or bottom of fill are likely to be knocked out by earthmoving activity. Furthermore, slope stakes are often marked with information on the slopes and distances in toward centerline or in toward the building pad or other feature. The information on the slope stake is often written in "progressive" form: distance and slope from offset stake to slope stake, distance and slope from slope stake to outside shoulder, distance and slope from outside shoulder to edge of pavement, on into centerline. Thus, the slope stake, placed safely beyond the area of construction, tells the story of the cuts and fills in toward centerline or toward the center of the work.

Catch points for both cut and fill are shown in the typical section graphics below. See these two figures.

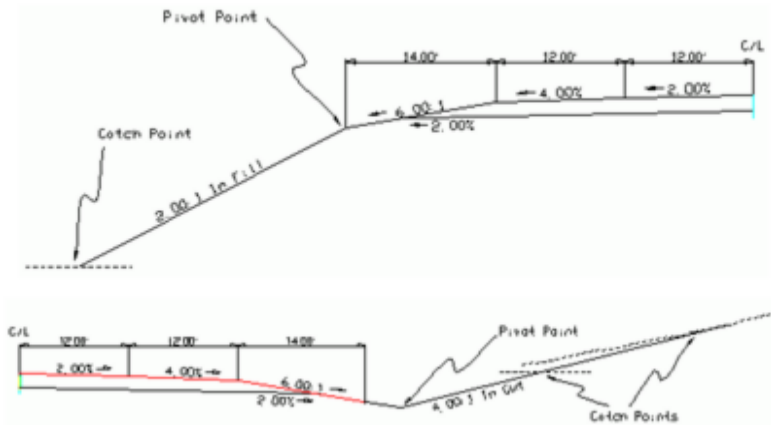

Note in the “cut” example above (bottom figure) how the catch point may be closer or farther from the pivot point based on the slope of the original ground. With flat ground at virtually the same elevation as the centerline of the road, the catch is found approximately 15 feet from the pivot point in the base of the ditch. But with ground sloping slightly uphill, it takes a full 30 feet or so to find the catch point. The program helps find the catch quickly by modeling the surface of the ground with each shot taken. Thus, by projecting the ground slope outward, the program advises the user how far to go to find the anticipated catch point. Unless the ground slope changes dramatically, the catch point is usually staked within just a few tries. With GPS, the process is even more automatic, since the ground elevation is being computed continuously as you walk toward the catch point. No “shot” has to be taken until you are positioned right on the catch point itself. This next figure shows a cut condition slope stake in 3D. The “catch” is located at the top of the cut.

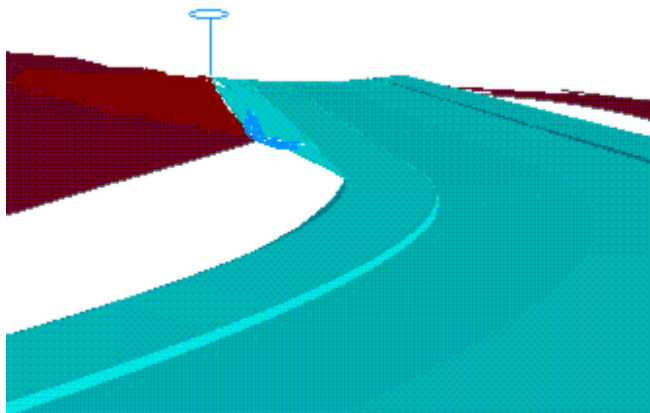

Four Methods of Slope Staking

- **User-Defined:** This is the most commonly used method of slope staking. Here, you simply enter the station, offset and elevation of the pivot point. Do not enter a minus sign for a left offset as in -25, since the program detects whether you are left or right of centerline. The only prerequisite is the selection of a centerline file. Cut and fill slopes are entered in the field.
- **Point-Defined Alignments:** This method is often used for staking the top of cut for a ditch, particularly a V-ditch. You can select the centerline by any of the three classic methods of centerline file, a picked polyline on the screen, or a sequence of points. The vertical alignment can be derived from any picked 3D polyline or from the elevations on the sequence of points, or you can separately enter a profile. This method is useful for slope staking existing flow lines, where you simply take two shots at either end, create an alignment by point number, then set the slope stakes at the user-entered slope ratio.
- **Design Files:** This is the most “formal” way of slope staking, but typically only applies to uniform, simple road, drainage ditch or levee projects where the pivot offset positions do not vary from station to station. While all methods require that a centerline be selected, the design file method additionally requires, at a minimum, a template file and a profile (vertical alignment). For more complex roads, superelevation files and template lane width transition files may also be entered. With the exception of the centerline, profiles and simple templates, the other files are usually created at the office using Carlson Civil, Carlson Roads or TakeOff, and then downloaded onto the field computer.

Note: Whenever the Road Design File option is selected, templates can be selected as a single “TPL” file, or as a series of templates organized as a “TSF” file (Template Series File). The TSF file can be entered within Road Utilities. If the left pavement lane of a road expanded from 10’ to 20’ for a passing lane, from station 1100 to 1200, you can create two templates, Road1 with the 10’ lane and Road2 with the 20’ lane. Then if you create the Template Series File shown below, the program will auto-calculate a 15’ left pavement width at station 1150. This same feature can be accomplished by using one template and applying a Template Transition File, which instructs on the changing dimensions of portions of a single template. Unlike the Template Series File, the alternate Template Transition File can only be created at the office using Carlson Civil, Carlson Roads or Carlson TakeOff.

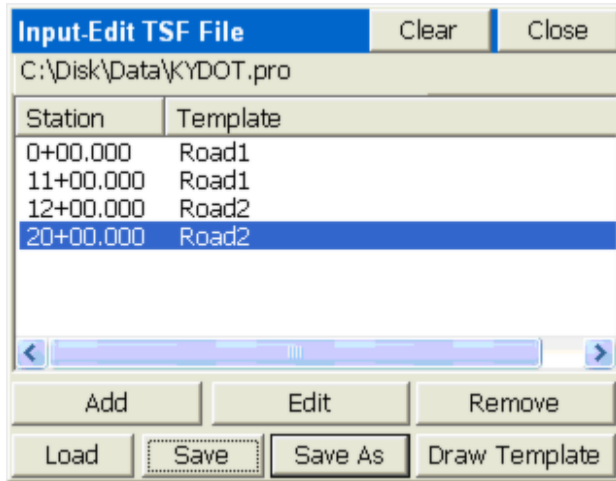

One advantage of the design files method is that since each template point has an “ID”, the slope stake report will include information to locate all ID’d template points from the slope stake back in to the centerline. In this way, the entire road can be built from the information marked on the slope stake, which is placed outside the construction area at a user-specified (eg. 5’) offset to the actual catch point.

A report might appear as follows:

	HDIST	VDIST	SLOPE
OFFSET to CATCH	5.02	-0.17	CUT 3.4%, 29.5:1
CATCH to PIVOT	32.20	16.10	FILL 50.0%, 2.0:1
PIVOT to SHLDR	14.00	33	FILL 16.7%, 6.0:1
SHLDR to EOP	12.00	0.48	FILL 4.0%, 25:1
EOP to CL	12.00	0.24	FILL 2.0%, 50:1

Within the program itself, the report might appear as shown here:

Offset Point Report			
<input checked="" type="radio"/> Progressive		<input type="radio"/> Total	
Offset PT Sta:	Offset:	Elevation:	
6+49.987	R126.906	997.219	
	HDIST	VDIST	SLOPE
OFFSET to CATCH	5.02	0.00	CUT 0.0%
CATCH to R651_5	87.24	43.62	CUT 50.0%
R651_5 to R651_4	10.66	5.33	CUT 50.0%
R651_4 to R651_3	6.00	2.00	FILL 33.3%
R651_3 to R651_2	4.00	0.17	CUT 4.3%
R651_2 to R651_1	3.99	0.17	CUT 4.3%
R651_1 to CENTER	10.00	0.43	CUT 4.3%

Progressive or Total: The above report is sometimes referred to as a “progressive” report, since it lists the incremental information from each break point to the next, going in toward the centerline. In some areas, the stake is referred to as a “story stake” or “progressive story stake”, because it tells the whole story of the gradework. The program is able to identify the names of the break points (eg. “SHLDR” and “EOP”) because the templates used by the program must have pre-defined IDs for all break points. Specifically with office-defined templates where cut conditions can have downslopes for ditches followed by upslopes, the program will auto-detect whether to pivot into fill or to create a cut condition, and pivot from the ditch line. You can also click the "Total" option and get offset distances to all break points as totals measured from the offset stake. In either case, the report is issued only if you stake the offset point to the catch.

- **Section Files:** Section files can be used to identify the pivot points left and right and minimize fieldwork. Consider the sections shown below.

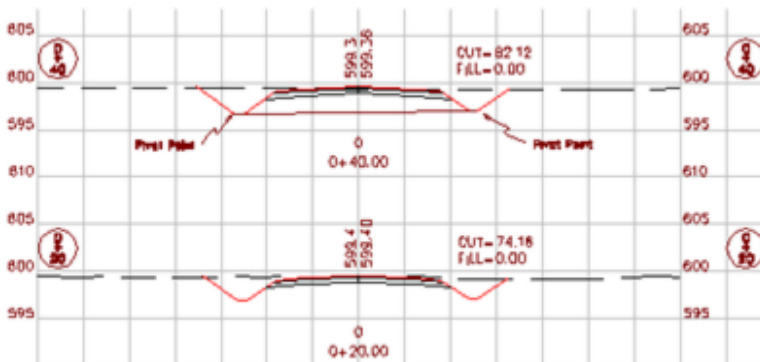

Shown are stations 0+20 and 0+40, with the pivot points for slope

staking identified on station 0+40. For the section approach to work, the left-most point in the cross section must be the left pivot, and similarly, the right-most point in the cross section must be the right pivot point. The section should only be entered from pivot left to pivot right (the “designed” catch points should be dropped). But since the interior section points have no bearing on the slope staking, they can be omitted, too. So in the case of station 0+40, a 2-point cross section could be entered, consisting of pivot left and pivot right. That 2-point section is also shown in the graphic above. It is just as effective for slope staking as a section containing all the break points between pivots. The one exception is if you have entered descriptions for your section points, you can obtain a progressive slope stake report, just as with the templates. Note that if descriptions do not exist, the report leaves them out. Section-based slope staking requires selection of a centerline file and field-entry of the cut and fill slopes.

Section-based slope staking is useful when the pivot points for stakeout vary unpredictably and don't conform to a fixed template. Section-based slope staking has 2 advantages. First, all sections can be entered in the office as 2-point sections (left and right pivot), minimizing field paperwork and reference material. Secondly, odd stations can be staked out (eg. station 0+27.5), since the pivot points can be straight-line interpolated by the program.

Note: Section files can be used for slope staking within the command **Stake Road**. In this routine, you can choose sections or templates to stake, and you can pick any point to slope stake from—so any point on the section can become the pivot point. The advantage of slope staking by section file within **Stake Road** is that you can pick any point (greater flexibility). The advantage of slope staking by section file within the **Stake Slope** routine is that it automatically uses the left and right end points of the section as pivot points, which means less screen picks are involved (greater speed).

Section files may be entered in Road Utilities, or in an external program such as Carlson Civil, Roads or TakeOff.

Choosing the Slope Staking Method

When Slope Staking is selected, you are presented with a Definition Method screen, where you choose among the 4 methods of Slope Staking: User-Defined, Point-Defined Alignments, Design Files or Section Files. The application of these methods is discussed above.

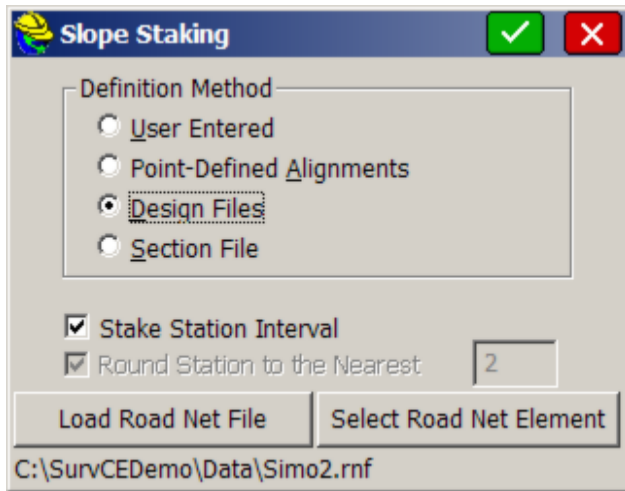

- Stake Station Interval:** When clicked on, your slope stake target is always a fixed point. It is the slope stake at the specified station in the input dialog in all 4 methods. But if clicked off, the slope stake target point moves forward/back station as you move. In User-Defined, the pivot offset and elevation is used regardless of station position. In the other methods, the pivot elevation is recalculated dynamically as you move based on the known information (3D points, profile, sections).
- Round Station:** This option applies only if you turn off “Stake Station Interval” and move to “fluid” slope staking. If you “round” to an interval, such as 5, then the elevation to stake from is calculated to the rounded station value, as is the up-down station position for the offset. Rounding only applies to the stored report—the target still moves fluidly as you walk forward or back parallel to the alignment.
- Load Road Net File/Select Road Element:** Carlson Civil 2008 and Carlson Roads 2008 have the option to output an "RNF" file, or "Road Net File", from the RoadNet feature. This file contains every centerline, cul-de-sac and road intersection "curve return" treatment for an entire road network. For example, a complete subdivision road system can be output as a single RNF file, and then SurvCE can stakeout any element of the RoadNet file that is loaded. Since the RNF file contains both templates and final sections, the Load RoadNet File option is accessible when slope staking by Design Files and Section Files. If you select, "Load RoadNet File", it merely loads the files, announces "Process Done" and all road files are placed into a temporary directory. You then need to click "Select RoadNet Element" to choose the element of interest. The three choices are centerlines, cul-de-sacs and the curve returns at intersections. For centerlines, the Center ID of the design template (if that method is used) is applied to the horizontal alignment. Keep in mind that for cul-de-sacs and curve-returns, the position of the horizontal alignment is set in RoadNet within Carlson Civil and Carlson Roads, and typically is set to the edge-of-pavement alignment position. Slope staking will therefore use just the outer part of the template, for example, from EP ID outward, to find that pivot point. If you re-load the

same RoadNet File, the program warns you that the prior temporary files will be erased and new ones created. This is done in case you actually modified a profile or other files in the temporary files, in which case you should use SaveAs in the appropriate command to preserve the changes in a new file name. When you Select RoadNet Element after loading an "RNF" file, you can highlight any element to stake, which then appear "dashed" when highlighted:

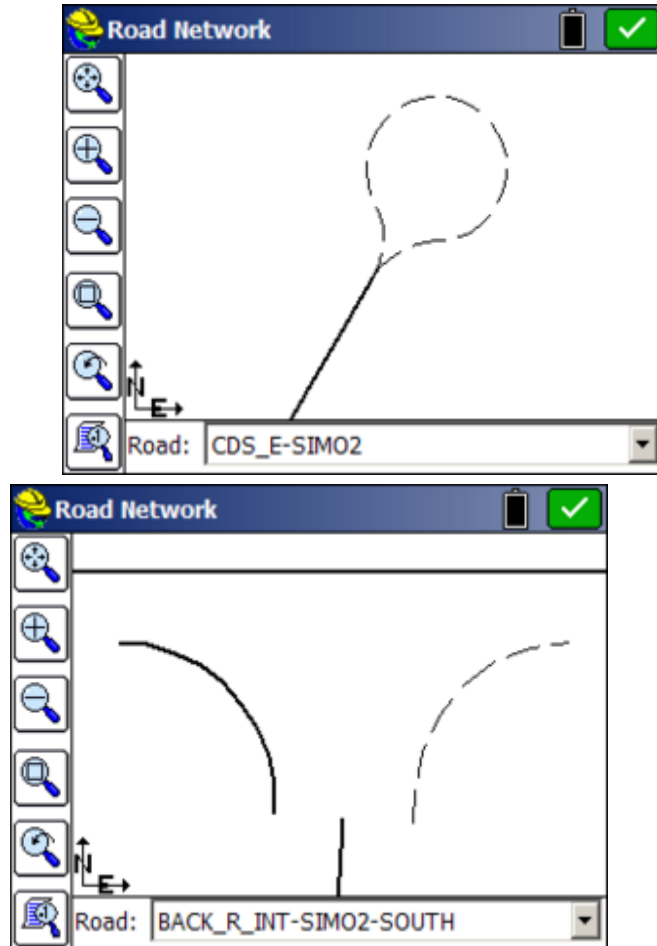

When you click out of the opening dialog that offers the 4 methods of Slope Staking, you obtain additional input screens.

- **User-Entered Dialog:** If the User-Entered method is selected, you are first prompted for a centerline, and a dialog appears.

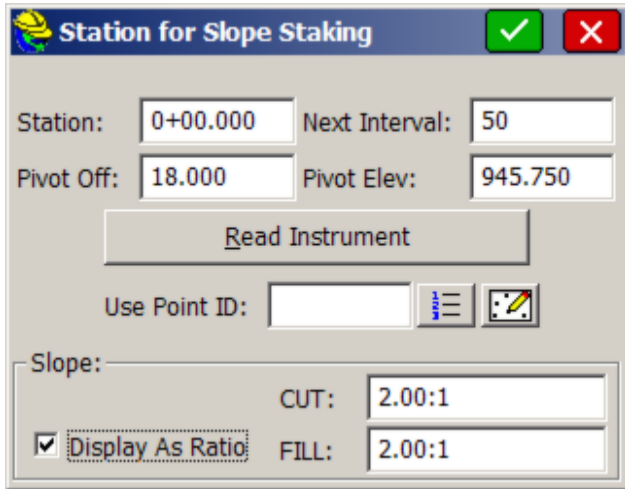

At each station, you can enter a specific pivot offset, pivot elevation and the cut and fill slope ratio that governs. Slope ratios can be entered as percent as well, is "Display As Ratio" is clicked off. Pivot offsets should be entered as positive numbers even left of centerline, since the program will detect which side of centerline you are on from the first total station or GPS reading. The program will take the absolute value of the pivot offset entry, in any case. You can obtain the position to stake from "Read Instrument", which calculates the station, offset and pivot elevation from a measured position. Or you can enter a point number to obtain a station, offset and pivot elevation.

- Point-Defined Alignment Dialog:** The selection of the Point-Defined method leads to the classic alignment selection screen, familiar to users of Offset Stakeout and Stake Centerline.

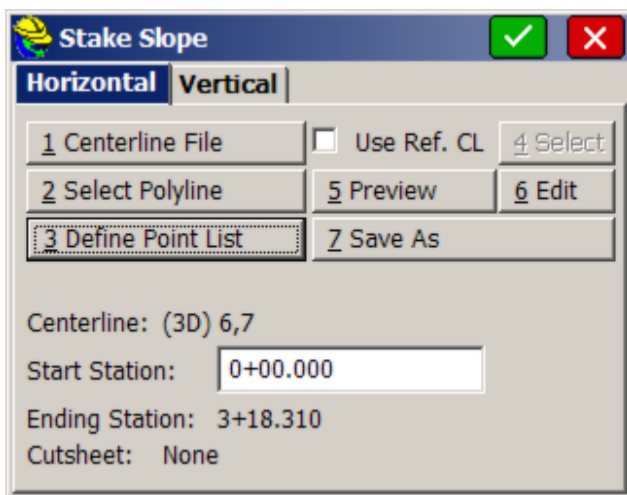

Though this is the classic use of the Point-Defined option (using points),

slope staking can be conducted from a single centerline and single profile or from a picked 3D polyline. Points can be selected by number or picked directly off the screen.

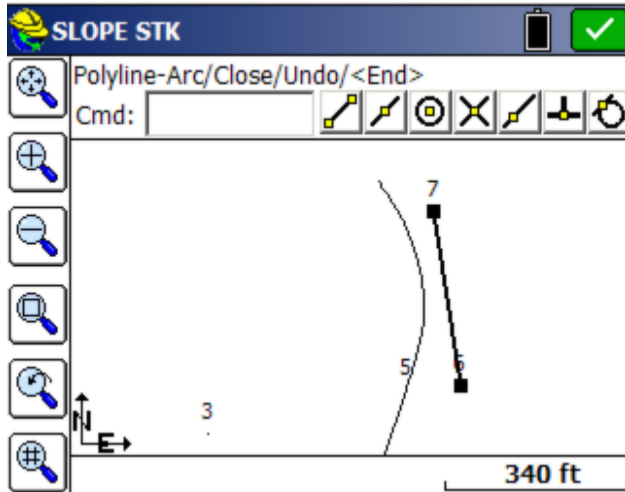

When a new horizontal alignment is selected by 3D polyline or point method, the program will ask if you wish to overwrite any existing vertical alignment selection. The typical answer is yes—you want it for both, and you are ready to stake any station at any interval based on user-entered slopes. Think of points 6 to 7 as the flow line of a ditch with steep side slopes, and the goal is to lay the slopes back at 2:1—a perfect application for Point-Defined Slope Staking.

- **Design File Dialog:** If you select Design Files, a dialog appears.

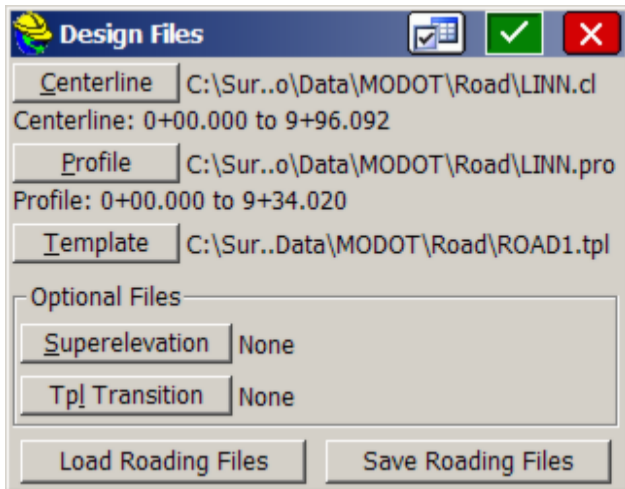

Centerlines, profiles and templates can be made using SurvCE. In fact, centerlines and profiles can be imported from a variety of file formats using

the commands within Road Utilities. Note that templates can be either single template “.tpl” files or multiple templates with transitions in a Template Series “.tsf” file. If the roads have superelevation, the “super” files can be made in Road Utilities. If template transition files are to be used for lane changes, then this file type must be made using external software such as Carlson Civil or Carlson Roads. Note that “sets” of Roding Files can be saved and loaded using the buttons at the bottom of the screen. The Settings icon at the top of the screen, to the left of the checkmark, allows you to place the profile grade at an offset to centerline, such as at the inside edge-of-pavement for divided highways, as shown below:

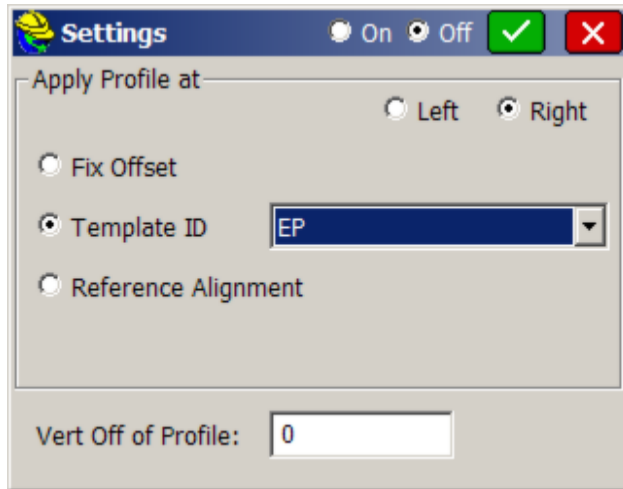

- **Section File Dialog:** If Section Files are selected, a dialog appears.

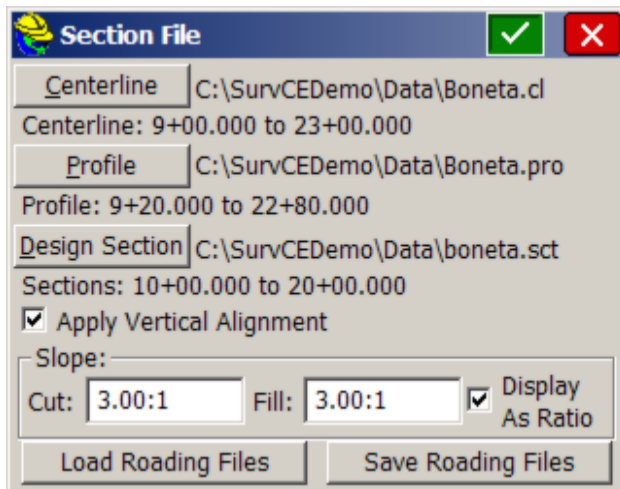

The Section file (which has an “sct” file extension) can be entered in Road Utilities or imported from the LandXML format using Section File

Conversion, also in Road Utilities. Note that for all roading design files, there is no requirement that starting and ending stations (chainage) match. All that is necessary is that they have a station range in common (in the above case, 10+00 through 20+00 is common to all files). Roading File sets (as in the above Boneta files) can also be saved to a named set and then re-loaded later for convenience. With cross sections, the profile is not required, but including the profile will lead to more accurate slope staking between known cross sections, such as at high and low points in the road.

Setting the Station and Interval for Stakeout

The next screen sets the station to stakeout and the interval and will appear in some form in all cases except section and design files slope staking with interval turned off. In effect, there are 8 ways of going into Slope Staking: 4 methods times 2 interval options (on=fixed station/off=fluid, real-time). You also have 3 more methods if you include the Stake Road routine which offers Slope Staking by Section, Template or Sections Cut from DTM, all fixed station.

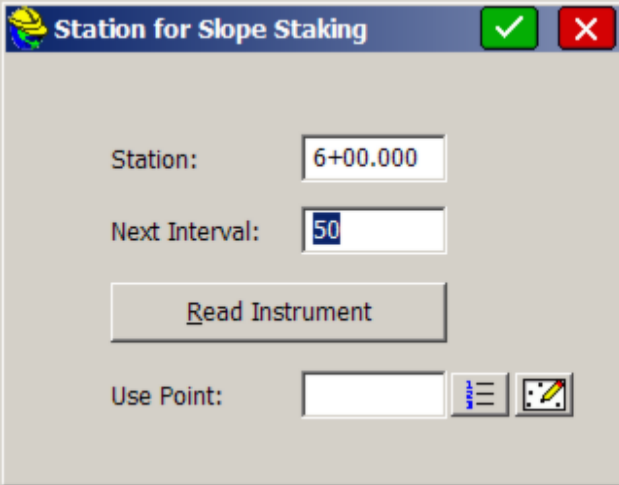

The station to stake can also be read from the GPS or total station measurement, allowing you to slope stake "where you are". You can also get the station by entering a point number, in which case it projects the point onto the centerline to determine the station. In the non-interval method, the above screen does not appear. You slope stake wherever you are all the time, and are freed of the constraints of staking a specified station.

The User-Defined and Point-Defined Alignment methods have their own pair of "follow-up" screens for the location to stake.

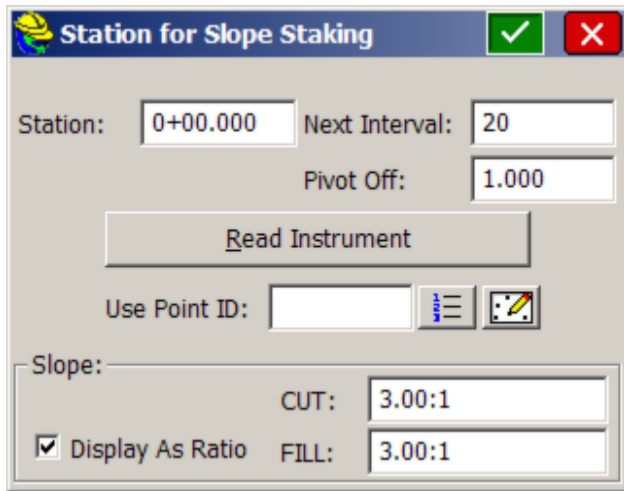

For flow line or V-ditch staking, a 0 pivot offset would be entered from the point-defined alignment. If the ditch were a trapezoidal ditch with a 2 meter bottom width, and the alignment was the centerline, each side of the ditch could be slope staked using a pivot offset of 1 (1/2 of the ditch width from center to pivot point).

Both the Road Design Files and Section Files methods go straight to the navigation (stakeout) screens if no interval is selected (Stake Station Interval turned off). The pivot offset is built into these methods based on the “rules” outlined earlier -- you stake from the pivot to cut or fill in templates, and from the extreme left and right points of cross sections. With interval turned off, slope staking by "User-Entered" method simply asks for the pivot offset and elevation at the current location, and slope staking by point-defined alignment asks only for pivot offset, obtaining the elevation from the vertical alignment.

Slope staking cannot occur outside the station range of the horizontal alignment. If your horizontal alignment runs from station 0 to 308, you can't stake station -10, either by interval method (naming the station) or by the non-interval, fluid “where-you-are” method.

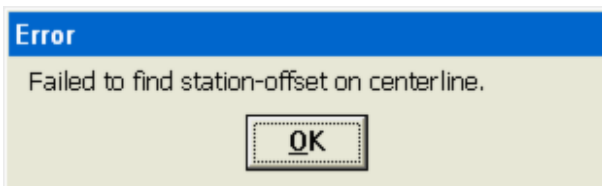

In live stakeout mode, you will get “Off Centerline” when beyond the range of the horizontal alignment.

All paths lead on to the navigation or stakeout (some call it “set out”) screen.

The Navigation (Stakeout) Screen

When configured for GPS, the navigation screen then appears.

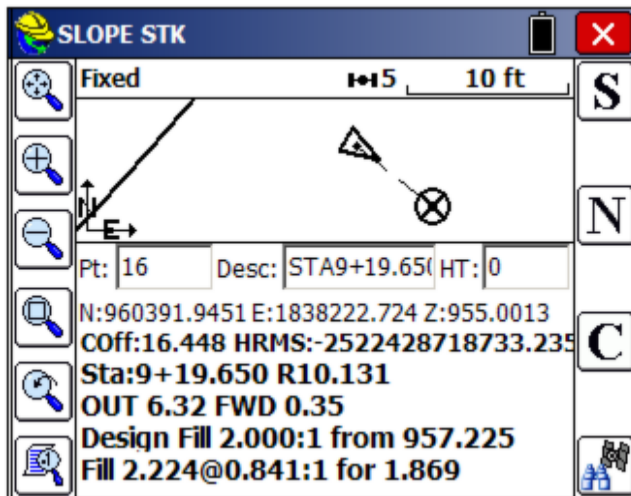

Note that because the GPS reads continuously and models the ground surface, the program calculates immediately where the catch point (the circle with the X) is located. You simply walk right to it. If the ground goes uphill or downhill as you approach the point, then the X will move closer or move away, until you are right on it.

As you get closer to the point (within the stake tolerance distance) the program will present a bullseye screen.

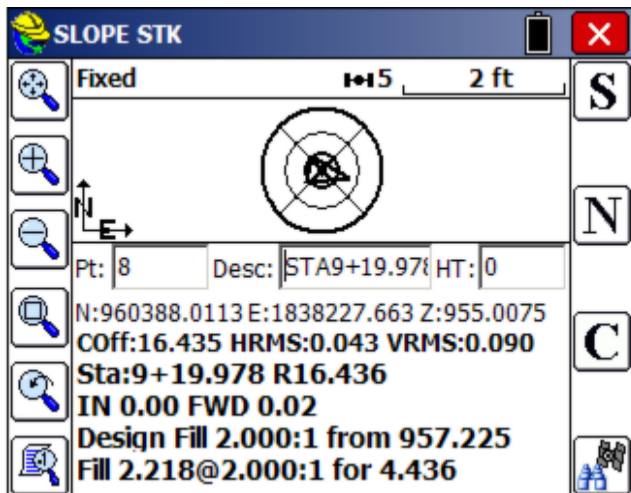

When you are satisfied with the accuracy of the slope stake position, you then touch S for Store (or press Enter to take the shot). In this case, its time to drive the stake.

Interval and Non-Interval Methods Impact Stakeout Screen

The stakeout screens above are for the interval method. In the non-interval, “fluid” slope staking, where you can drive the stake anywhere, the “Forward-Back” portion of the screen becomes vertical “Current Fill” or “Current Cut”. In this fluid stake-out mode, you simply move in or out from the centerline to set the slope stake—there is no correct or incorrect forward or back station. So the program instead reports the vertical up to the fill slope above you or down to the cut below you.

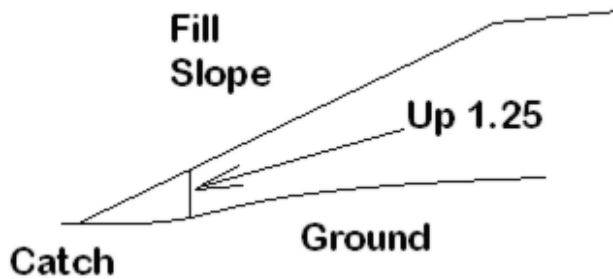

If you are moving out to the catch point along the ground, you would get a report of “CrF 1.25” or some such number, and the “Current Fill” amount to the ground would decrease as you approach the catch. The actual stakeout screen would appear as shown below. Note that some surveyors will watch the lower line (1.6:1 for 3.65) and just keep moving out until they see 2:1 (or the desired slope) and drive the stake. Others will watch the “CrF” value decrease to 0 and drive the stake, or watch “OUT” decrease to 0.

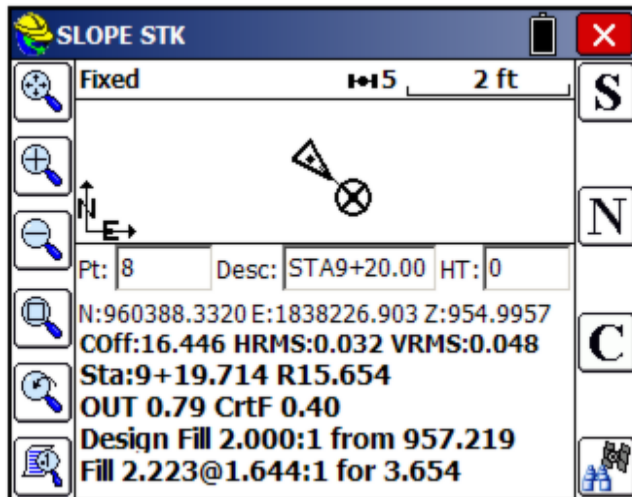

Storing the Slope Stake and Offset Stake Points

When S for Store is pressed, you may store the actual slope stake point. You can also store a first offset point (since the slope stake itself can be removed by

construction). The slope stake information is typically written on the first offset stake. Then you can also stake a second offset point, to obtain “line” to reset the slope stake if it is knocked out. The first and second offset stakes provide a direction back to the slope stake. When the slope stake is set, the program prompts for setting the first offset stake. When the first offset stake is set, the program prompts for setting the second offset stake. Both offset stakes are optional.

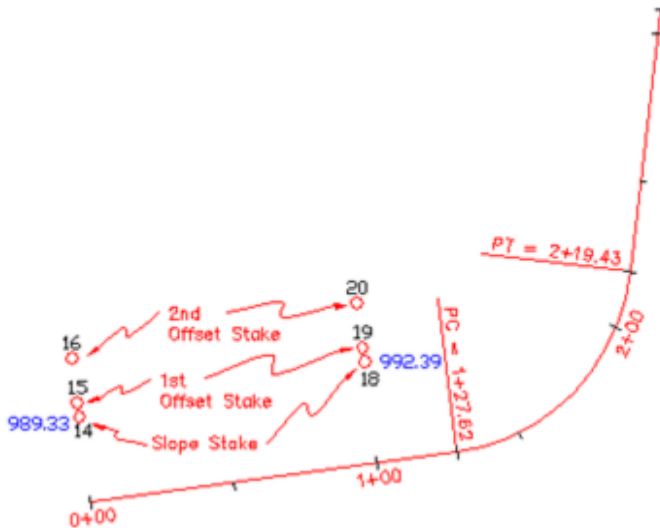

The storage of the slope stake points is an option turned on by clicking “Store Point to CRD File”. With this clicked off, you can simply slope stake and avoid storing any points. The Description for the point will default to the station and offset. Slope Staking will not respond to settings in Configure Reading for the Height/Description prompt screen. If you are using a named “Slope Stake File” (set in **File, Job Settings, Stake** tab, **Cutsheets** option), you can still control at the point of staking whether you choose to append data to the file by clicking on or off “Store Data to Report File”.

Slope Staking Store		
	<input type="radio"/> Offset	<input checked="" type="radio"/> Elevation
Pivot Pt: 6+00.000	R18.000	945.750
Catch Pt: 6+00.000	R36.501	955.001
Stake Pt: 5+99.992	R36.478	955.001
Stk-CP: OUT 0.023	FWD 0.008	
Stk-PP: C9.251 @ 1.997:1	HD:18.478	50.063%
Stk-CL: C6.251 @ 5.836:1	HD:36.478	17.135%
<input checked="" type="checkbox"/> Store Data to Report File		
VOff: <input type="text" value="0"/>	Elv: <input type="text" value="955.001"/>	C(Stk-PP)9.25
Point ID: <input type="text" value="8"/>	<input checked="" type="checkbox"/> Store Point to CRD File	
Desc: <input type="text" value="STA5+99.992 CATCH R36.48"/>		

Slope Staking Store		
	<input checked="" type="radio"/> Offset	<input type="radio"/> Elevation
Pivot Pt: 6+00.000	R18.000	945.750
Catch Pt: 6+00.000	R38.562	956.031
Stake Pt: 5+99.298	R38.562	955.008
Stk-CP: F1.023	FWD 0.702	
CP-PP: C10.281 @ 2:1	HD:20.562	50%
Stk-PP: C9.258 @ 2.221:1	HD:20.562	45.025%
Stk-CL: C6.258 @ 6.162:1	HD:38.562	16.229%
<input checked="" type="checkbox"/> Store Data to Report File		
VOff: <input type="text" value="0"/>	Elv: <input type="text" value="955.008"/>	C(Stk-PP)9.26
Point ID: <input type="text" value="8"/>	<input checked="" type="checkbox"/> Store Point to CRD File	
Desc: <input type="text" value="STA5+99.298 CATCH R38.56"/>		

Note that there are two options for the slope stake report: Elevation and Offset. The standard option is the **Elevation** method. This assumes you were able to survey the actual slope stake point with reasonable accuracy, and it reports the actual stake to pivot point results. If you were staking a 2:1 cut slope, it reports your actual slope (as 1.997:1 in this case), and you can choose to round the result and write "Cut 2:1, 9.25 V, 18.48 H" on the stake. But if at the catch point there are boulders in the way, you can walk out and away from centerline in cut and in toward centerline in fill, and drive the stake where you can. In this case, you would choose the **Offset** method. In the Offset example above, we had to walk past the catch point about 2 units (from 36.50 to 38.56). We drive the stake, and note that the catch is at 956.03 rather than 955.01, so we measure up 1.02 on the stake, and draw a horizontal line there as the catch point. An extra line appears in the report that tells us to write "Cut 2:1, 10.28 V, 20.56 H" on the stake. In cases of fill where there are obstructions, walk into centerline so when you drive the stake, you can mark where the fill intersects the stake. Note that this same level of reporting occurs with "non-interval" staking, where you get real-time cut and fill at any point, also allowing you to drive the stake to avoid obstructions.

When Enter or OK is pressed, you are prompted for whether to stake the first offset stake.

Station	<input type="radio"/> Offset	<input checked="" type="radio"/> Elevation
Pivot Pt: 0+00.000	R0.000	997.230
Catch Pt: 0+00.000	R126.670	955.007
Stake Pt: 0+00.049	R126.726	955.007

Stk-CP: IN 0.055 BACK 0.049

Stk-PP: F42.223 @ 3.001:1 HD:126.726/33.319%

Store Data to Report File

VOff: Elv: F(Stk-PP)42.22

Point ID: Store Point to CRD File

Desc:

If you are doing “User-Defined” or “Point-Defined Alignment” methods, you are shown the horizontal distance and vertical fill or cut difference to the pivot point, which can be written on the Slope Stake. Additional break-point information appears if you are using the “Design File” or “Section File” method. If you trust that the Slope Stake will not be knocked out, then you are done—no need to set an offset stake.

Pressing OK leads to the prompt to set the first offset stake. If you choose to set the first offset stake, then you can set the offset distance.

Station:

Offset:

Offset Type

CL Offset Delta Distance from Catch Pt

Press OK and then you are in a standard stakeout screen. The offset point is a fixed location and the stakeout procedure is similar to point stakeout. This leads

to a report of information that can be written on the Slope Stake. Finally, you will be prompted for staking out a second Slope Stake, to establish “line.” After the first offset stake is set, and before the prompt for the optional second offset stake, a summary screen will appear. If you have used the Road Design File or Section File methods, you will be presented with every break point into centerline.

Offset Point Report [✓]

Progressive Total

Offset PT Sta: Offset: Elevation:
6+49.994 R39.976 954.987

	HDIST	VDIST	SLOPE	
OFFSET to CATCH	4.97	0.01	FILL	0.3% 34
CATCH to BD	17.00	8.50	CUT	50.0% 2
BD to EP	6.00	3.00	FILL	50.0% 2
EP to CENTER	12.00	0.00	FILL	0.0% 99

Offset Point Report [✓]

Progressive Total

Offset PT Sta: Offset: Elevation:
6+49.994 R39.976 954.987

	HDIST	VDIST	SLOPE	
OFFSET to CATCH	4.97	0.01	FILL	0.3% 34
OFFSET to BD	21.98	8.49	CUT	38.6%
OFFSET to EP	27.98	5.49	CUT	19.6%
OFFSET to CENTER	39.98	5.49	CUT	13.7%

Finally, you will be prompted for staking out a second Slope Stake, a more rarely used option whose purpose is to establish “line” (the direction) from the first offset stake to the slope stake itself. This permits accurate replacement of the slope stake when it is knocked out by construction activity.

Note: When using Road Design or Section Files in Slope Staking, setting the first offset point is the recommended procedure, as it produces the full report, referenced to cross section and template IDs, for all break points all the way into the centerline point.

Procedure for Slope Staking with Total Stations

The procedure is nearly identical for Total Stations, except that you must press R

for Read (or Enter) to take shots and allow the program to begin calculating the Slope Stake position. Unlike the GPS, SurvCE cannot predict the location of the target slope stake point until at least one measurement is taken.

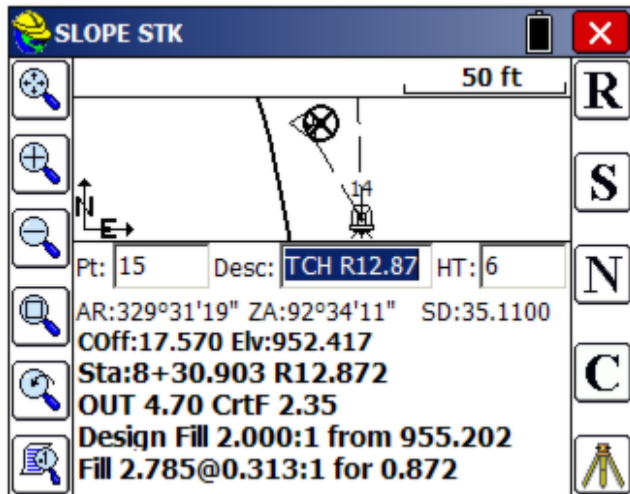

Note: When using either GPS or total stations for slope staking, you can obtain more graphics and less screen information by pressing the down arrow key. It literally has the effect of bringing the graphic screen down (see below). Pressing the up arrow key will pull the screen back up and show the full text. This works in all modes except GPS Simulation, where the up arrow moves the cursor faster, down arrow slower.

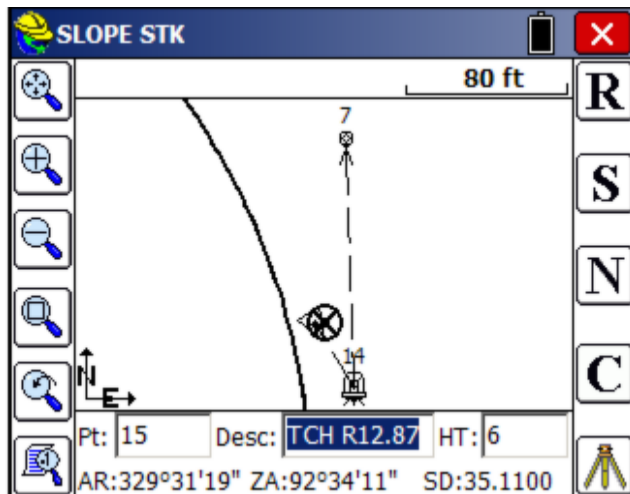

The Slope Stake Report and Writing on the Slope Stake

Surveyors doing slope staking have the option to write the information on the stake as each is surveyed, or to come back at a later time, refer to the slope stake report, and write on all the stakes after the surveying is complete. The slope stake

report file is a comma-separated “.txt” file, configured in **Job Settings, Stake, Cutsheets**, which might appear as follows if formatted in Excel or another spreadsheet form:

#Des Sta	Des Off	Des Elv	Staked Sta	Staked Off	Staked Elv	Desc
1+00.000	L33.849	998.075	0+99.966	L33.453	998.075	Catch Point
1+00.000	L38.849	-----	1+00.019	L38.866	998.15	First Offset Point

Here is another example as viewed in the Edit mode within Job Settings, Stake, Cutsheets, Edit Slope Stake.

Design Sta	Pivot Off	Elev: PP/C
7+00.00	Right 18.0	947.75
OFFSET to CATCH	H 0.00	V 0.00
OFFSET to BD	H 14.49	V 7.24
OFFSET to EP	H 20.49	V 4.24
OFFSET to CENTER	H 32.49	V 4.24
7+50.00	Right 18.0	949.50
OFFSET to CATCH	H 0.00	V 0.00

The columns are configurable with the Slope Stake formatting in Job Settings. Shown above is a "total" report (as opposed to "progressive"). No offset stake was set. The template involved was flat from centerline for 12', then had a 2:1 slope for 6' into a ditch point (ID="BD" for "base of ditch"). This cut downslope condition was created within an office-entered template using Carlson Civil or Carlson Roads, and SurvCE automatically detected the cut condition and used the ditch points as pivot points, offset 18 with elevations 945.75 at station 6+00 and 946.50 at station 6+50. Some survey teams use one person to set the slope stakes and another to enter data on the stakes, which is easily done using the stored slope stake report above.

Store Sections

This function collects as-built cross sections of roads or other alignments and stores them optionally as points, as cross sections or as an ASCII file organized by station. The station and offset can be stored into the description field of the points. The station itself can be set to automatically round to the nearest 5, 10 or other station interval (eg. a shot at 177+98.23 would round to 180+00 if a

rounding of 5 or 10 is used). The information can be stored into a “.txt” ASCII file in addition to the points themselves, if "Store Comma Separated File" is turned on, and if point storage is turned on, you can save a ".not" file of the station and offset. You can save the cross section data to a cross section file in .SCT or RAW/Geodimeter format. Store Sections can also be used simply to verify your current station and offset as you move along a centerline using GPS or taking total station shots.

This routine is often combined with office software to check as-built road cross sections against desired grade and to calculate quantities for payment. The field crew begins by taking shots along each desired cross section, as shown in this figure.

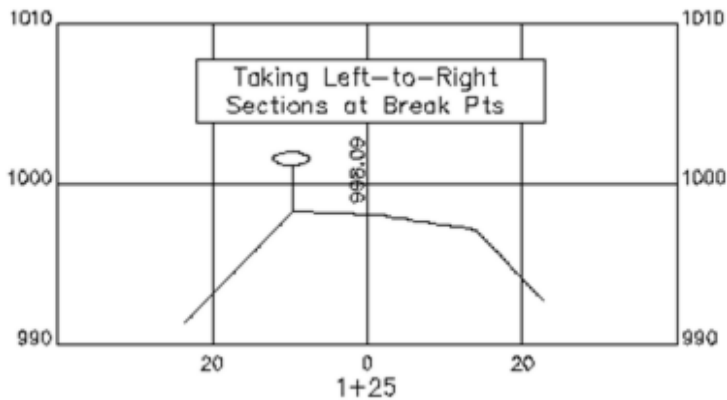

If, for example, four sets of cross sections were taken from station 0+75 to 1+50, the points would appear as shown in the plan view below, and the 3D view shown below that. There is an option to turn off point number storing, in which case the shots can still be stored to a cross section (.sct) file and report file (.txt).

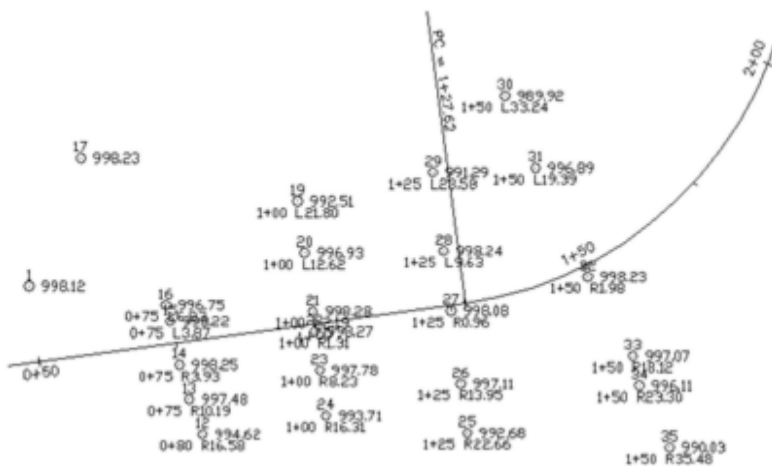

Here, below, we see the 3D view of this area.

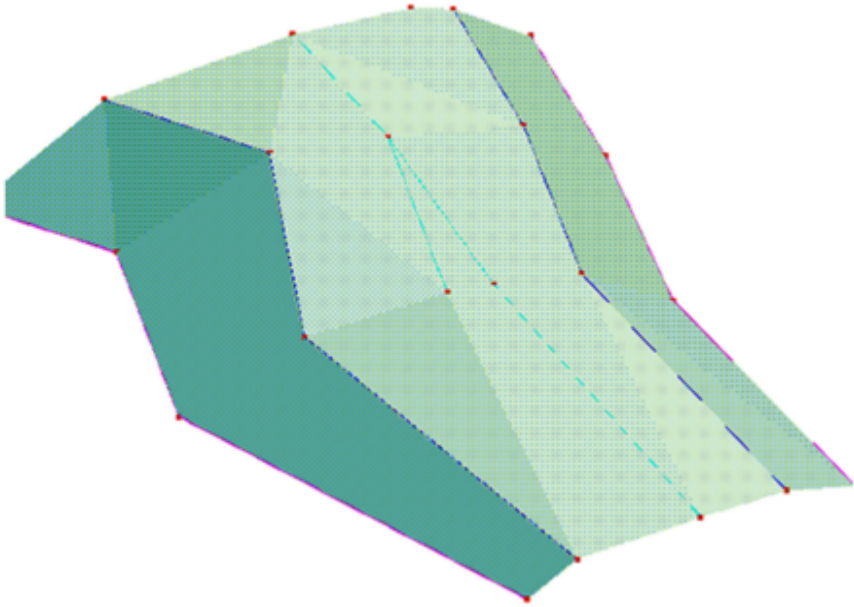

The command begins with a screen where you select the method for defining a centerline.

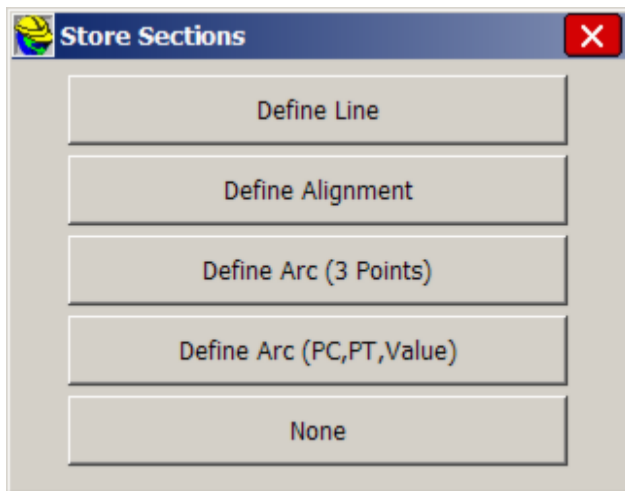

The next screen allows you to choose whether or not to store a file summarizing cross section data. Because the SCT method requires that you choose an alignment, the option for no alignment (“None”) only applies to the Raw/Geodimeter method, in which case a named file is required. Except for this case of option “None”, the Section output file is optional because the information will be stored with the points. When you click Select File, you have two file type options when using a horizontal alignment.

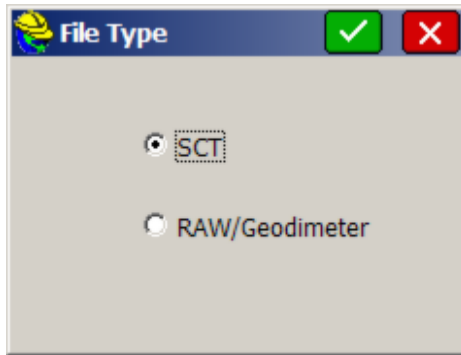

The Raw file format is a design that is compatible with the old Geodimeter section file format, and includes special prompting for job type. It is discussed in detail below (see the discussion of “None” as centerline option). It leads to a different set of screen options than the SCT format.

Unless you are looking for Geodimeter file format compatibility, you should consider storing a section output file in the “.SCT” format, since it can be converted, using Road Utilities, to LandXML form and then imported to several different roading software packages for plotting and computation of volumes. The “.SCT” section files can also be used directly for volume calculations with Carlson Roads, Leica Site Manager, Topcon Topsite and Carlson Civil. You can also set the rounding—here, a rounding of 10 units (feet or meters) has been selected. The station and offset can also be stored as the point description and as a note file, if the lower options are clicked on.

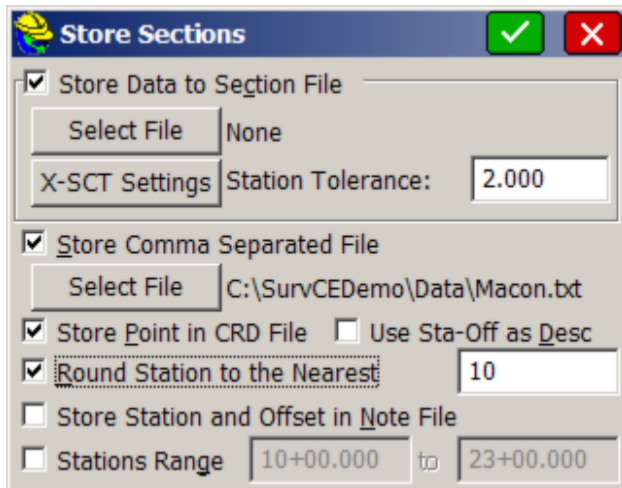

Note that the rounding is fully automatic. If you choose a 5-unit rounding, and are targeting station 0+75, but take a shot at 0+77.93, it will round up to 0+80.

Before collecting the cross sections, it is important to click X-SCT Settings near

the top of the dialog, and set the stations you wish to capture. This way, if the station rounds, per the above screen, to a station that doesn't exist in your list, you are warned before proceeding with storing. This list also includes the left and right "tolerances" for the offsets, which will lead to warnings if you exceed that distance from centerline. If you set a tighter "Station Tolerance" in X-SCT Settings (option Edit) than the "Rounding" Tolerance, you will be warned even though the rounding is correct. In the screen shown below, station 16+70.000 has been added as a special station. Clicking the first line (10+00.000-23+00.000) allows you to set the standard interval, and the additional stations in the list would be for special stations in addition to the standard interval.

Station	Offset Left	Offset Right
10+00.000-23+00.000	100.000	100.000
10+00.000	100.000	100.000
10+11.570	100.000	100.000
16+70.000	100.000	100.000
23+00.000	100.000	100.000

The below, smaller dialog appears when you tap Add Odd Stations, shown in the above figure.

Add odd station ✓ ✕
 MIN Sta: 10+00.000
 MAX Sta: 23+00.000
 Station:
 Left Offset:
 Right Offset:

With the first line highlighted, selecting Edit leads to the settings options for the full range of stations.

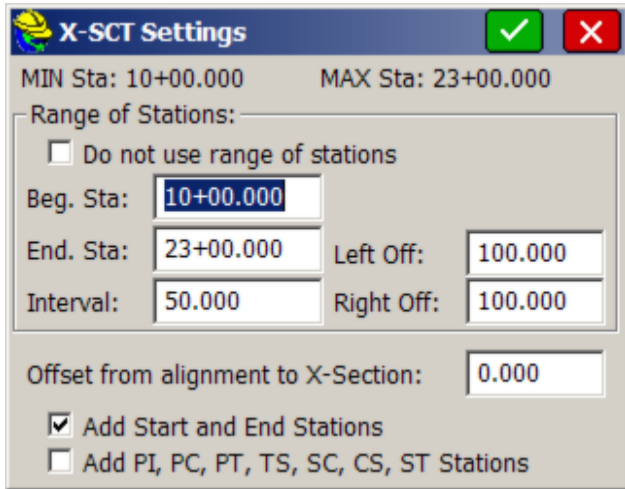

X-SCT Settings

MIN Sta: 10+00.000 MAX Sta: 23+00.000

Range of Stations:

Do not use range of stations

Beg. Sta: 10+00.000

End. Sta: 23+00.000 Left Off: 100.000

Interval: 50.000 Right Off: 100.000

Offset from alignment to X-Section: 0.000

Add Start and End Stations

Add PI, PC, PT, TS, SC, CS, ST Stations

With an interval set of 50, and Start/End Stations turned on, the program will only expect you to capture stations at 50 units intervals starting at 10+00 through to 23+00, but also including 10+11.57 and 16+70 in this case. The Offset from alignment to X-Section option lets you, in effect, use an alternate, parallel centerline at a left (negative) or right offset from the main centerline. Unless the Raw/Geodimeter method is used, a station “warning” screen is used if the rounded station is not in the list or pre-selected stations. A capture of station 1075 would round to 1080, but since 1080 is not in “the list”, you will be warned before storing. A station of 1667 would round to 1670, which is in the list, leading to no warning screen. Since the rounding was set to 10 in this example, data collected at 45 to 55 would round to 50 (station 1053 would not round up to 1055), and therefore only “even 10” stations will be collected to begin with. So the additional “Station Tolerance”, which rounds the collected station data to the listed stations, will not activate.

When OK (green check mark) is clicked from the Store Sections dialog, the program immediately proceeds to a point collection mode, with continuous presentation of station and offset (if running GPS or robotic total stations).

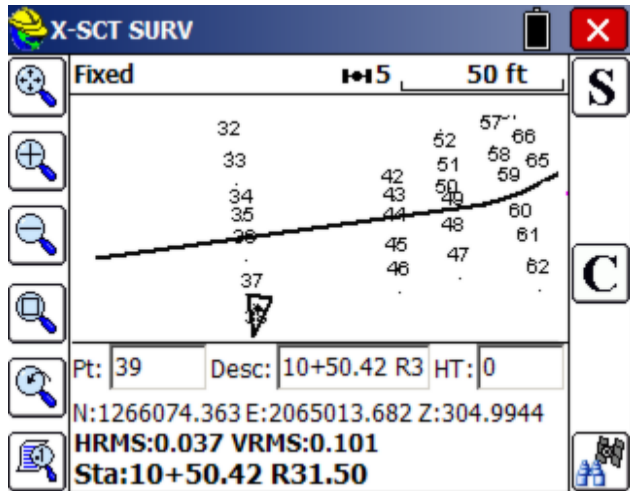

- Storing Points using GPS:** There are two methods for storing points in real-time GPS mode: Press the S icon at right (or pick Alt S) or simply press Enter. The “binoculars” icon will bring up the Monitor/Skyplot dialog. You can survey as many cross sections as desired within the command. Unlike in Slope Staking, Store Sections will respond to the setting for Hgt/Description prompt on save, found in Configure Reading, allowing you to arrow key to desired descriptions or change your rod height after taking the shot. Option C goes to the Configure Reading directly from the data gathering screen. When done, simply select the Menu button, and you are returned to the Road menu. When exiting by pressing Menu, if you have opted to store to an SCT file, you will be prompted to store the cross section information in SCT form.
- Storing Points using Total Stations:** After confirming the occupied station and backsight, as with all total station work, proceed through the same options above until you reach the store point dialog. In the example below, our centerline is metric, starting at station 0+000.

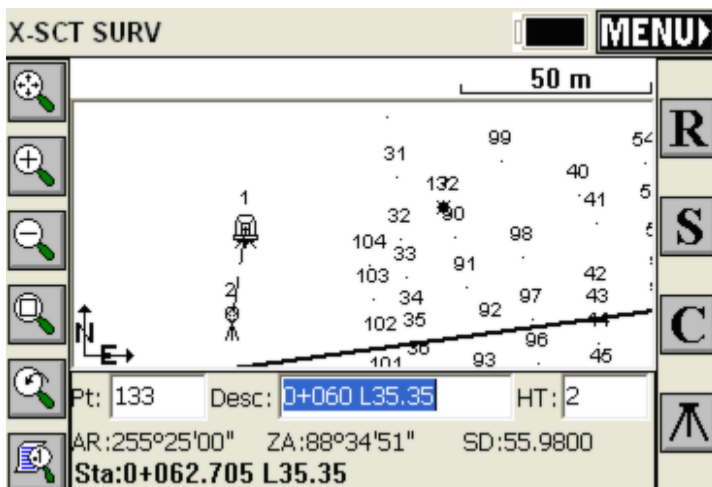

Here, your options are R for read, followed by S for Store, or simply Enter to Read and Store. The backsight icon can be pressed to set a new occupied point or backsight point. Note that we have a very “busy” screen of points. If you just want to see your setup, backsight and last point that was measured, press Alt F. This produces the screen below. You will stay in this mode until you press Alt F again and toggle back to the presentation of all points.

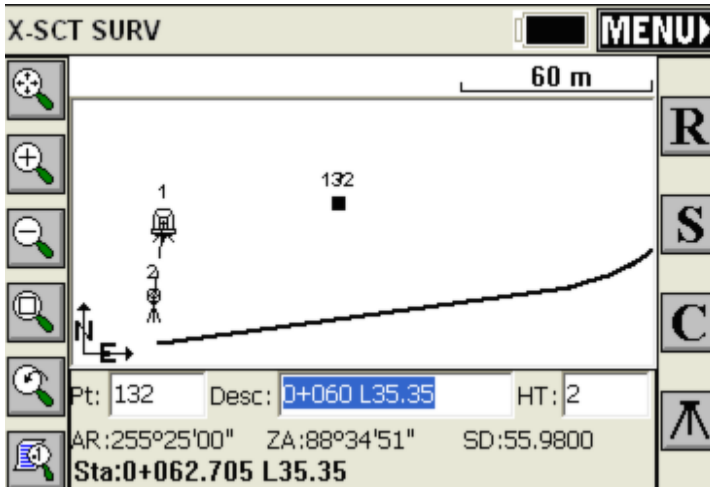

If a shot is taken that doesn't round to a station in the list of “approved” cross section stations (X-SCT Settings), then a warning screen appears. In the warning dialog shown below, the tolerance has been exceeded on two accounts. We round to 0+80, which is not in the list, and our offset is 186.891 left, which exceeds our anticipated maximum offsets of 100 left and right.

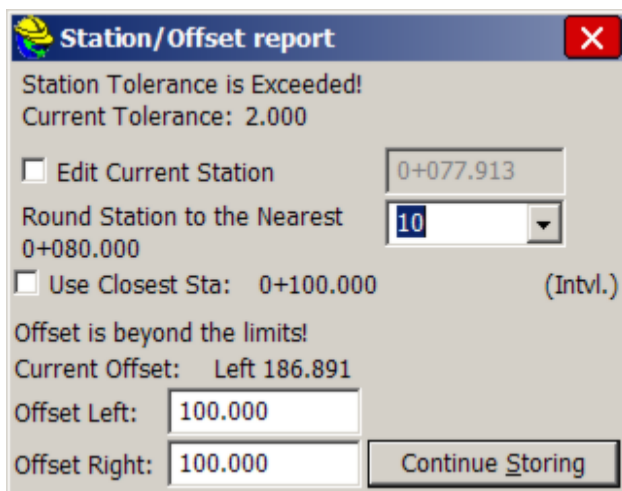

Points Store with Station/Offset Descriptions, as shown below:

29	0+125	L23.58
30	0+150	L33.24
31	0+150	L19.39
32	0+150	R1.98
33	0+150	R18.12

The comma-separated file would appear as follows if presented in a tab-delimited form:

#Point ID	Station	Offset	Elevation	Description
29	0+125	Left 23.5759	991.2901	0+125 L23.58
30	0+150	Left 33.2363	989.9193	0+150 L33.24
31	0+150	Left 19.3923	996.8921	0+150 L19.39
32	0+150	Right 1.9816	998.2340	0+150 R1.98
33	0+150	Right 18.1201	997.0731	0+150 R18.12

When you exit the routine by clicking Menu from the data gathering screen, and have Store SCT file turned on, you will be asked if you want to “process” or add the last shots you collected to the named SCT file. You have the choice to “Process” (use the data) or “Discard”.

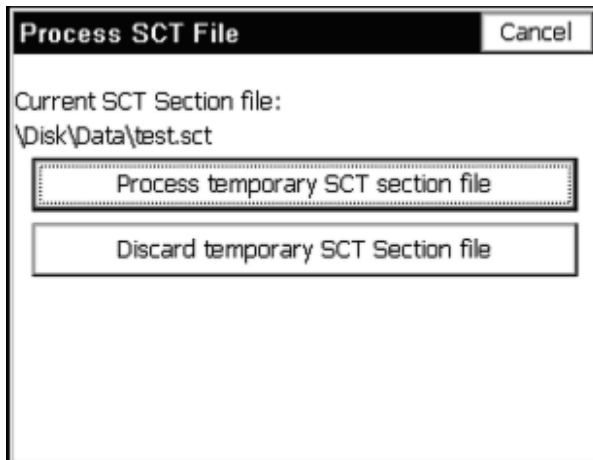

The program will even keep the section data “on file”, so that if you Cancel the above screen, and re-enter Store Sections, you will be prompted again whether to save (process) or discard the cross section data collected earlier.

Options When Storing in Raw/Geodimeter Format

Different options present themselves when the Raw/Geodimeter Format, or File Type, is chosen.

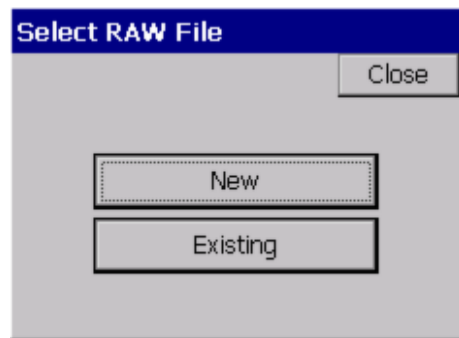
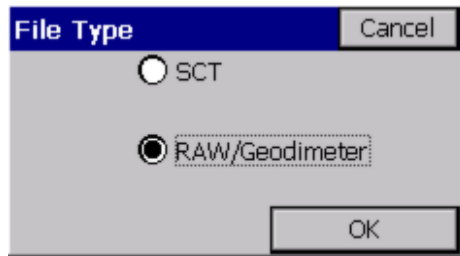

When Raw/Geodimeter is selected, a distinct set of screens are obtained. This particular format was adapted for highway departments and survey companies that had built cross sectioning practices around the Geodimeter format. This method requires that you enter the station (chainage) being surveyed, and only uses the centerline position to advise you on your station and offset. A horizontal alignment is not required. The program detects the selection of this format, and before proceeding, opens with a starting screen where job-based information is entered.

Cross Section				OK
Project	104 North			
Info	As-Builts 240-300			
Operator	VF			
Instr. No.	3	Date	3-28-2004	
Temp.	65.0	Press.	30.10	
Signal Ht.	2.100			
X-Sec Type:		<input type="radio"/> Originals	<input checked="" type="radio"/> Finals	
X-Sec Job	Typicals	Task	Cross Sections	
	Roadway		Bridge Survey	
	Borrow		Setout Dev.	
	Offtake		Cross Sections	
	Extensions		Profile	
	Topsoil		Topography	
	Subcut		Fly Levels	
	Bench Cut			

There are pre-set job categories and tasks, which save into defined number categories in the old Geodimeter raw file format. Whereas the SCT method recognizes the station you are on and automatically rounds to it when you are within tolerance, the Raw/Geodimeter method requires that you click the Station button, and set your target station for collection of cross section data.

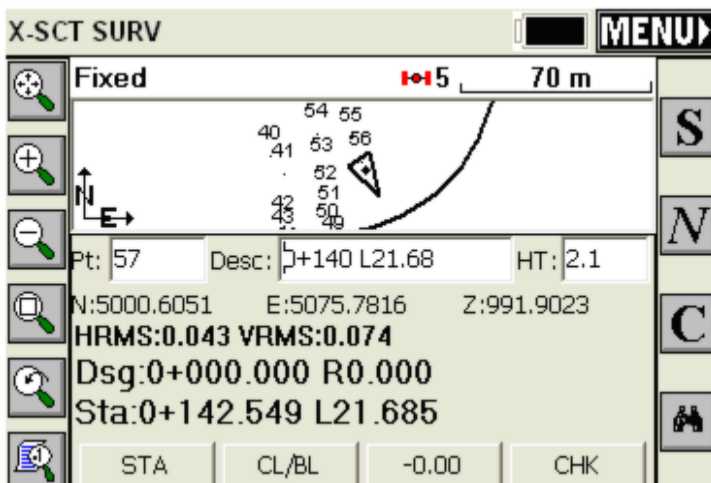

Then you proceed from the current location to the target station. In fact, although the points that are stored may contain station and offset descriptions, the data stored to the raw file pays no attention to the centerline information. The station and offset on the screen act only as a check on your current location. The direction of taking the sections, (L to R or R to L), is important and is set by specifying “Chainage Direction”. Unlike with the SCT format method, pressing Menu to exit does not store the data, but instead the data is automatically stored as you go, as a series of 37 (N), 38 (E) and 39 (Z) record types (Geodimeter format), with header line records, as shown below:

```

50=XSEC1
54=104 North
0=As-Builts 240-300
53=VF
90=2
97=0
51=3-28-2004
56=65.0
74=30.10
55=3
96=2
6=2.100
80=280.000
91=1
37=5105.857
38=5069.091
39=991.905
37=5104.091
38=5074.931
39=990.724

```

Starting left to right, the data points begin with a 91=1 record. A right to left

section would begin with 91=2. When you “cross 0” or are on the centerline or baseline, you click the CL/BL button which sets a 92=1 record for centerline and 92=2 for baseline, and the next shot is the centerline/baseline shot. If you select the “-0.00” button, this indicates whether the next shot is a tie-in (catch) or extension beyond the tie-in. This sets a 93=1 record for the catch and 93=2 for the extension prior to the subsequent coordinate record. In effect, you tell the program where the centerline or baseline is by shooting that point. Then the station and offsets of the shots for that cross section are determined relative to that center-of-alignment shot. It does not use a horizontal alignment combined with rounding to determine the station and offset of the shots (like the SCT method does). You tell it the station, the direction of measurement (left to right or vice versa) and you tell it which one is the center shot. This is why the Raw/Geodimeter method is the only method that works with no centerline (the “None” option). For each section, you tell it the station and center shot, and all other measurements are used to determine the left and right offsets relative to the center shot. If the L to R method was used, shots before the center shot are on the left, for example, and their offset is determined by the inversed distance to the center shot. The centerline file or other form of horizontal alignment, if selected, is academic and only used to advise you on your current station and offset. The CHK button will allow checking into known points to be sure that tight coordinate control is maintained. N moves onto the next station as defined by the interval set using the Sta button.

Note: The .SCT file method is the standard Store Sections method. The RAW/Geodimeter method is a flexible routine designed to adapt to customers who have built their cross section processing systems around the Geodimeter raw file format.

Stake Road

Stake Road is one of four major commands used in highway work. This command is designed to stakeout specific stations and offsets along a centerline and can be used for slope staking. For example, if your goal is to stakeout the break points like edge-of-pavement and shoulder at station 87+80 on a given road centerline, you would use **Stake Road**. **Stake Road**, therefore, is used primarily to lay out road surfaces for construction. **Stake Road** is typically used to set cut and fill stakes or “blue tops” at specific stations and offsets. The elevation used to determine the cut or fill at each offset is derived from either design files (the template interacting with the profile and centerline) or from cross sections or from sections that are “cut” from alignments. The "Road Model File" option loads a LandXML file containing alignments for each break in grade, such as edge-of-pavement, shoulder and ditch lines. In each case, at any specific station, you will be guided to the desired offset and will get a cut or fill. By contrast, if the goal were to simply set random cut and fill stakes along an alignment, at no particular station or offset, then the command **Elevation Difference** would be used. If the goal is to stake out the “catch” in cut and fill, where cut slopes and fill slopes meet existing ground, then **Stake Slope** would be used. However, you can also Slope Stake within **Stake Road**, with the advantage of having the option to see both a section and plan view. **Stake Slope**, by contrast, has one advantage over Stake Road in that it can slope stake at any position, and does not require a

station to be specified. The fourth, major highway-oriented feature is **Store Sections**, which is used to gather “as-built” information on a road. In this command, you take cross sections of data points along the road, at random or specific stations. In summary, **Stake Slope** starts the cut and fill work, **Stake Road** directs the precise roadbed work and fine grading, **Elevation Difference** acts as a quick grade check, and **Store Sections** produces the final confirmation of the as-built road for payment and certification. It is highly recommended for all road stakeout that you set on "Use CL for Reference Object" within **Configure**, View Point tab.

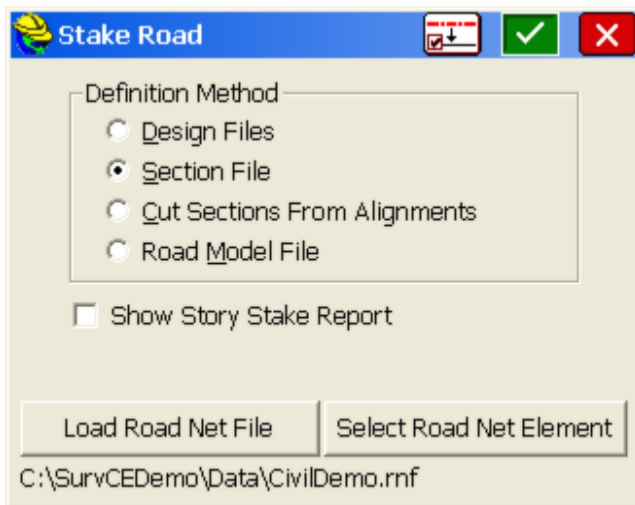

Opening Screen

- Reference Centerline Button:**  In the opening screen, the button up top, left of the the green check (OK), is the "Reference Centerline" button. This button allows a second centerline to be used for instructions on forward and back, Left and Right to stake the point calculated from the primary, first centerline. This is useful when the primary centerline is curving and where a single point may be offset from different positions along the centerline. The second, reference centerline is usually the main road centerline, so that forward-back, left and right instructions are easy to follow. Because this feature is rarely used, its very appearance is configurable. You must turn it on in File, Job Settings, Stake Tab, Alignment Settings, Option "Allow Reference Centerline". If checked, this means a reference centerline will be used for the road options Design Files, Section File and Road Model File. Note that if the refence centerline is on, but carried forward from another job, you might obtain extremely large station and offset data, possibly with negative numbers. The reference centerline station and offset data is always presented with an asterisk (*), so if you see the asterisk followed by clearly erroneous data, look to see if the reference centerline has been left on, pointing to an incorrect centerline, and turn it off.
- Story Stake:** The middle zone of the opening screen in Stake Road shows

the 4 methods of defining the road, described below. Underneath the method options is the option to turn on "Show Story Stake Report". If this is selected on, then ANY point that is staked out on the road will lead to an entire report on all breaks, starting on the far outside of the section on the side you are on, to the point you staked, then past that point all the way to centerline, as shown below. Note that your current staked position is SHLD1, so since this is on the right side of the road, the first page of the report and the first line of the second page shown cover distances to offsets further to the right, and the lower portion of the second page cover distances from your staked position in to centerline. You can also see the relative cut and fill and distance to the break points on the other side of the road if you click off "Show Report up to CENTER". Then the report would be even longer! Similar to the Slope Stake Report, you can see the progressive horizontal and vertical distances or the total to you current, staked position. Although it is standard to do these reports and mark slope stakes, the Story Stake allows you to mark ANY stake, not just the slope stakes on the outside of the road, but, for example, mark all information on a central depressed median stake, which the contractor can then reference. The Story Stake report applies to all Stake Road methods.

The image shows two screenshots of the 'Offset Point Report' dialog box. Both screenshots have the following settings:
 Progressive Total
 Show Report Up to CENTER
 Offset PT Sta: 21915.000 Offset: R46.258 Elevation: 32.091

Left Screenshot (Report up to CENTER):

	HDIST	VDIST	SLOPE
OFFSET to DITCH1	113.14	13.70	CUT 12.1%
OFFSET to SHLD6	89.17	1.72	CUT 1.9%
OFFSET to SHLD5	83.67	1.27	CUT 1.5%
OFFSET to ROAD6	73.67	0.85	CUT 1.1%
OFFSET to ROAD4	49.67	0.30	CUT 0.6%
OFFSET to ROAD3	37.67	0.02	CUT 0.1%

Right Screenshot (Report up to SHLD1):

	HDIST	VDIST	SLOPE
OFFSET to DITCH	13.67	1.18	CUT 8.6%
OFFSET to SHLD1	0.00	0.18	FILL 999.9%
OFFSET to SHLD	4.00	0.11	FILL 2.8%
OFFSET to ROAD2	10.00	0.00	CUT 0.0%
OFFSET to ROAD	22.26	0.23	CUT 1.0%
OFFSET to CENTER	46.26	0.68	CUT 1.5%

- Road Network (.rnf) Files:** The Carlson Civil module of the Carlson office software has a command called Road Networks that will output both design files and cross section files for street intersections and cul-de-sacs, in addition to main alignment segments of the road. The breakthrough feature allows for staking out of complex intersections, including what are sometimes called the "curve returns" where the edge-of-pavements and other breaklines, in effect, are filleted with inscribed curves. The multiple curves of cul-de-sacs can also be output. It is highly recommended that when Road Network Files are used, you should select the Section File method of stakeout within Stake Road. The outputting of Road Network files is found within Settings in the Road Network command in Carlson Civil, as shown below as "Write SurvCE Stakeout":

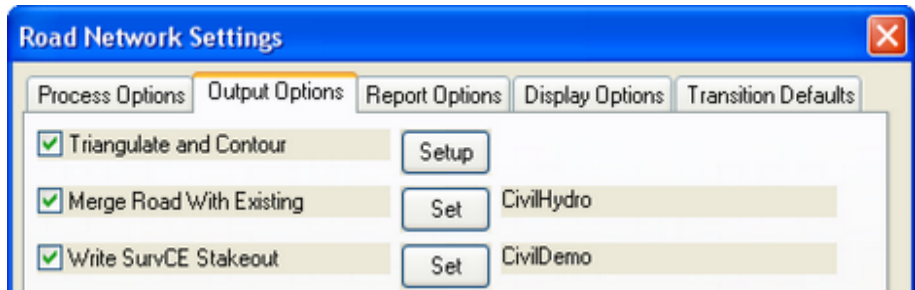

Defining the Road

The first dialog that comes up when you select Stake Road is where you define the road by selecting one of the following options.

- Design Files:** In Carlson SurvCE, design files include templates, centerline, profile and optionally, superelevation and template transition files. If you wish to “clear” a file such as a superelevation file, just click it and choose Cancel. The definitions for each of these files is covered in their own sections of this manual. Design files are recommended for subdivision streets, access roads and simpler highway designs. The Template Grade Table file which can be input and edited under Road Utilities also is used as a "design" file and replaces the need for template transition and superelevation files, covering both options by specifying cross slopes and grade widths across any station range for any template ID.
- Section Files:** Sections are made up of simple offsets and elevations that can have optional descriptions such as “EOP”, “DL” or “SH” and must be accompanied by a horizontal alignment file (centerline). The vertical alignment or profile is optional but improves accuracy at high and low points. Every cross section is a “snapshot” of the template at a given station. SurvCE supports using multiple surfaces simultaneously in Stake Road by using multiple section files or by extracting the section for each surface when all surfaces are within a single file (as exported by Carlson Civil). Each surface can exist on its own layer with its own color for easy identification while in the Stake Road dialog. For complex designs, with non-conforming intersections, transition lanes, special ditches, etc., it is recommended to use cross section data if available. Longitudinal pipes can also be displayed in cross section and staked out.
- Cut Section from Alignments:** Provides the ability to extract cross sections directly from 3D polylines that exist within SurvCE. The first thing you need to define is the horizontal and vertical alignment files. These form the basis for cutting the sections and determining left and right offsets from the horizontal alignment or centerline. The centerline-defining screen is similar to the screens found in Stakeout Line and other commands.
- Road Model File:** Loads a LandXML "model" of all alignments associated with the road. Each "break point" on the road such as centerline, edge-of-pavements, shoulders and ditch lines can be considered to have its own horizontal and vertical alignment. By including all of these files in a single LandXML file, and by user selection of the true centerline for

stationing purposes, the entire road can be defined in the form of a multi-alignment LandXML file. This method is commonly used in Scandinavia, the UK and by some U.S. Departments of Transportation.

Design File Method

Design File Example Demo: Provided with SurvCE and SurvPC are sets of roading files called Demo.cl (centerline, horizontal alignment), Demo.pro (profile, vertical alignment) and Demo.tpl (template). In SurvCE, these are known as "design files" for road work. In particular, the template is a rule-based design file controlling grade cross slopes, and including definitions for road lanes, curbs and cut and fill slopes. This template approach is best for simple roads such as subdivision and building access roads where rules are strictly followed (except at intersections). For intersections and cul-de-sacs, Road Network Files (.rnf files) from Carlson Civil can be used for stakeout (best done using "Section Files"). Design Files can be acted on by template transition files (which expand and contract road lanes), by superelevation files (which alter cross slopes) and by template grade table files (which both change lane dimensions AND cross slopes). Here is an example of a simple road. You can follow along using the 3 "Demo" files (.cl, .pro and .tpl).

Begin by starting a job named Demo. It does not matter whether you are in metric units or feet. If there are any points in the file, go to Cogo, Keyboard Input, Utilities and delete all points by range (or enter ALL). You can delete any points one-by-one using File, Points, highlight and delete. Now draw the Demo.cl centerline using the command, in the Map screen, under Tools, Centerline, Draw CL to Map. Then use Cogo, Create Points, Polyline to Points to turn the centerline into points at all vertices and radius points. Start numbering at point 1.

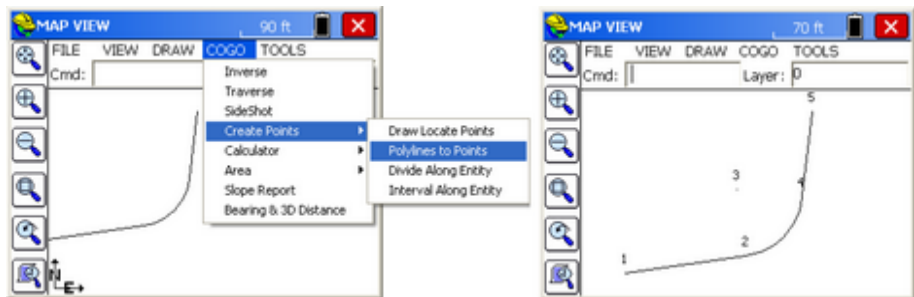

The next step is to go to Roads, Stake Roads, be sure no reference centerline is selected (button at top of screen) and select Design Files. To turn off any of the 3 files in the lower, optional section of the dialog (lower left), click those items and remove file using Cancel (red X). Note that the stationing of the centerline and profile do not need to match--they just need to have areas of overlap to work. In this case, the end station nearly matches perfectly (308.327 vs 308). So you could not stake out station 308.1--there is no extrapolation on the vertical alignment. You will be warned, "No Cross Section..." if you enter 308.1 to stake.

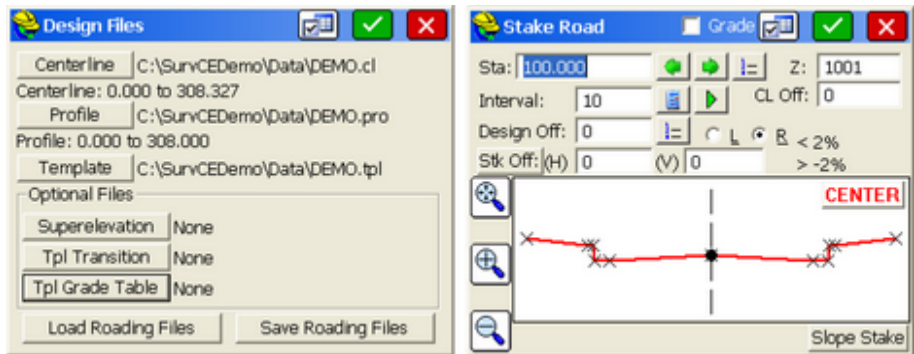

The settings button in the Design Files screen allows application of the profile to any template ID--the default is "Center" or center of road. For divided highways, the profile grade is often the inside edge-of-pavement, rather than the center (which might be a concrete median or central ditch). The settings button in the Stake Road dialog above goes to the standard, 3-tab Road Stake dialog also accessible in Job Settings, Stake option. This controls various things such as vertical exaggeration (here 4x was used) and key station points to increment through (eg. PC, PT, high points, low points). Select a Design Offset of 0 by entering it or picking the middle of the template (zoom extents to center the template). Set a Stake Offset H=0 and V=0. Note that the slope into the selected point (left of center) is displayed as 2% and the slope right of center is displayed as -2%. Slopes in this display are calculated left to right, not outward from centerline (in which case both slopes would be -2%). Select any point on the template to stake, either graphically by picking or by entering a point. If you pick graphically, you must pick a template "break point", indicated by the X's. All template break points have template IDs like EP for Edge-of-Pavement and SH for Shoulder. If you enter an offset, you can select a point that is not a break point, such as 5.5 Left (shown below):

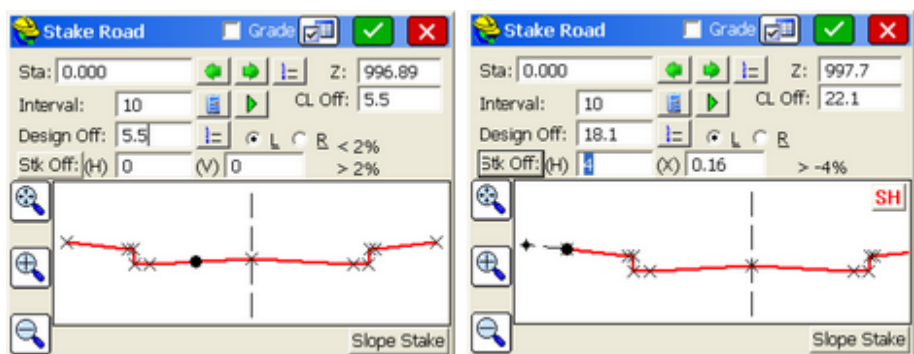

If you click OK, you begin the stakeout process (requiring Localization if running GPS Simulation). Another option is to stake an offset. Click on the far left template point (SH) and then enter an offset of 4 units. Then if you want to extend the slope of the last segment, click the "Stk Off" button, choose Extend Current Slope option, and return back to the above right screen. Note the vertical

offset is calculated for you (you can always direct enter the vertical offset if you know it). Also note as you make these various changes to the target point to stake, the Z elevation in the upper right of the screen is re-calculated and the target "CL Offset" distance is displayed, which is now distinct from the Design Offset. When ready, click OK to stake out.

Design File Example with 4% Cross Slope Superelevation using

Superelevation File: Let's say the road goes through a superelevation of 4% at the PC at station 127.62 and complete superelevation of 4% at the PT station of 219.62, transitioning from normal crown to full super in 90 feet (eg. 37.62 start transition, pivot from -2% to 2% on outer lane to "reverse crown" at 97.62 and reach 4% full super at 127.62). In this way, the rate of transition of the outside lane on the curve left is 2% each 30 length of road. Complete the same transition in reverse after the PT, from 219.62 at 4% to 249.62 "reverse crown" (2% slope both lanes) to 309.62 end full super. This can be accomplished by 2 methods: (1) Superelevation Files applied to a single Template or .tpl file or (2) by (Template Series Files--using 3 templates: normal crown, reverse crown and full super). It is very important to first define the template ID point outside of which no superelevation rules are applies. If you have a curb and gutter road, usually the edge-of-pavement (EP in this case) is the outside lane to apply the superelevation--all template points beyond that follow their original definition, including the 4% uphill shoulder slope, even when in superelevation.

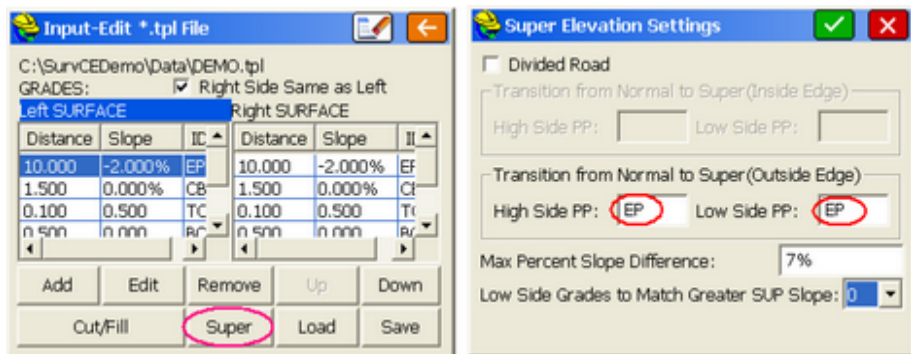

Now to accomplish the above superelevation by use of a superelevation file, enter the following within Road, Utilities, Input-Edit Superelevation Files:

Add Super (Stations):

Begin Transition: 37.620 Begin Run-In: 67.620
Reverse Crown rate in: 97.620
Grade Slope(%): 2.000 Design Speed: 35.00
Curve Type: Spiral Circular
Max slope of Full Super(%): 4
Begin Full Super: 127.620 End Full Super: 219.620
Reverse Crown rate out: 249.620
 Reverse Curve End Run-Off: 279.620 End Transition: 309.620

Superelevation List: Demo

Begin Trans	Run-In	Norm Out	Run-Off	End Trans
37.620	67.620	249.620	279.620	309.620

Add Edit Remove Clear
EQ Load Save As

Note that 3 transition points are defined: (1) begin transition, (2) run-in and run-out where the pivoting outer lane side has a zero cross slope), reverse crown and full super. So between these 3 transition points, the rate of transition may vary. In this case the rate is the same, 2% every 30 units of length on the outside lane. This entry creates one line of superelevation, one for each curve involved. When this is applied, note cross slopes at stations 67.62 (2% and 0%), 97.62 (2%) and at station 127.62 (4%) below:

Design Files

Centerline: C:\SurvCEDemo\Data\demo.cl
Centerline: 0.000 to 308.327
Profile: C:\SurvCEDemo\Data\demo.pro
Profile: 0.000 to 308.000
Template: C:\SurvCEDemo\Data\DEMO.tpl
Optional Files
Superelevation: C:\SurvCEDemo\Data\Demo.SUP
Tpl Transition: None
Tpl Grade Table: None
Load Roding Files Save Roding Files

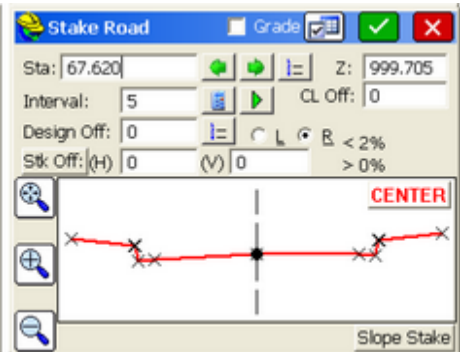

Shown below are the reverse crown and full super sections at station 97.62 and 127.62:

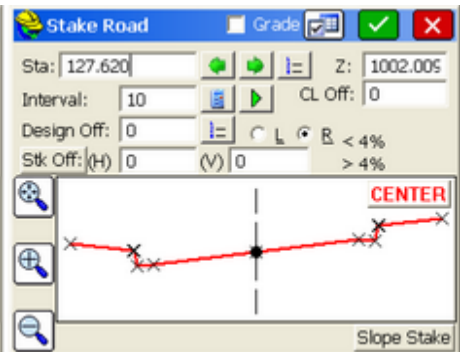
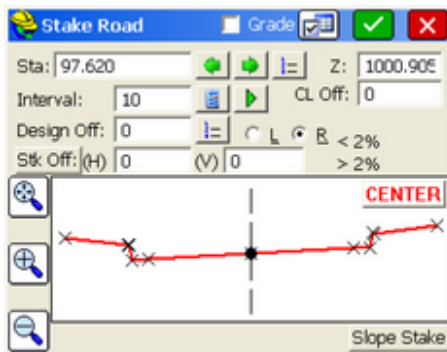

Design File Example with 4% Superelevation Plus Lane Width Changes using Template Series (.tsf) File: Another way to accomplish lane-controlled superelevation is to use distinct templates, linked together as a "Template Series" file. In addition to the standard 10 width road at 2%, add another template for the reverse crown condition and a third template for full super. You need all three, since there is no slope change on the low side until reverse crown at 2% (same slope L and R) is achieved, at which point both sides pivot to full superelevation. We choose to do a second reverse crown template of 8 width to illustrate that you can also change the lane width on any of the additional templates, for a simultaneous reduction or expansion in lane width through superelevation. Here are 2 of the additional templates for this example:

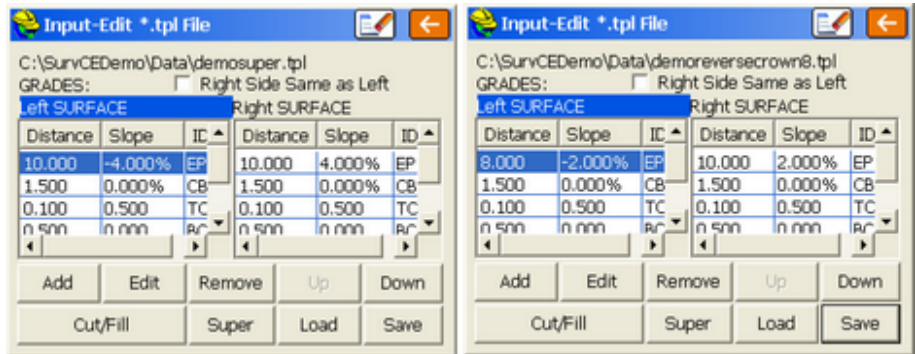

Note here that we have added an additional aspect of lane reduction to 8 units for the Demoreversecrown8.tpl template on the left side. Here we are designing a normal transition up to full super, and then exiting full super at 10 unit width for the EP, transitioning to reverse crown at only 8 unit lane width. So that transition would occur from the PTstation 219.62 to reverse crown to at 249.62. To stay and finish at 8 unit lane width for the EP left, we need 1 more final Demo8. TPL, defined as having a 8 unit EP width, left side. This Template Series file is then created in Road, Utilities, option Input-Edit Template Series. Clear anything that is there (erase icon) and then enter as shown:

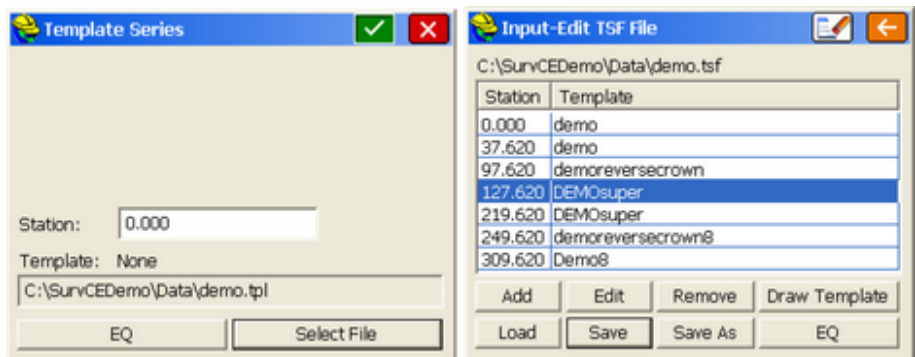

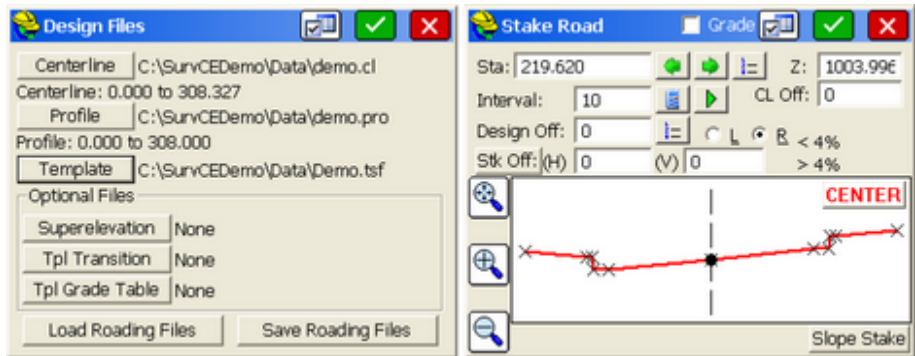

Now when Stake Road is run, station 219.62 shows full super and the transition to a 8 unit lane width occurs from 219.62 to 249.62, holding 8 width on the EP lane

through to the end (station 308). Note below left that when selecting the template, you actually load the demo.tsf template series file which includes reference to ALL of the various templates as defined within Input-Edit TSF File. You do not use any optional files in the lower half of the dialog.



Compare station 219.62 above (end of full superelevation) to station 127.62 (start of full super) further above as defined by superelevation files. They are similar. Also note station 234.62. It is halfway through the transition from 10 width to 8 width on the left side (EP=9 Design Offset), and also transitioning from full super (4%) to reverse crown (2%). At station 308, the road superelevation has not fully transitioned back to 2% (at station 309.62). Wherever you pick the middle right of the display shows the cross slope left and cross slope right of your picked point. So the cross slope on the right side is -1.89% trending downward to -2%. Also note the shorter dimension (8 units) of the EP lane left of centerline. The variations in the road shown below can be seen in "drive through" mode by entering the starting station, picking an offset to follow (such as Center) and

clicking the Green Arrow  opposite the word Interval. This drives through the site at the selected interval, and you can watch grades rise and fall, expand and contract. The Red Box stops the process. 

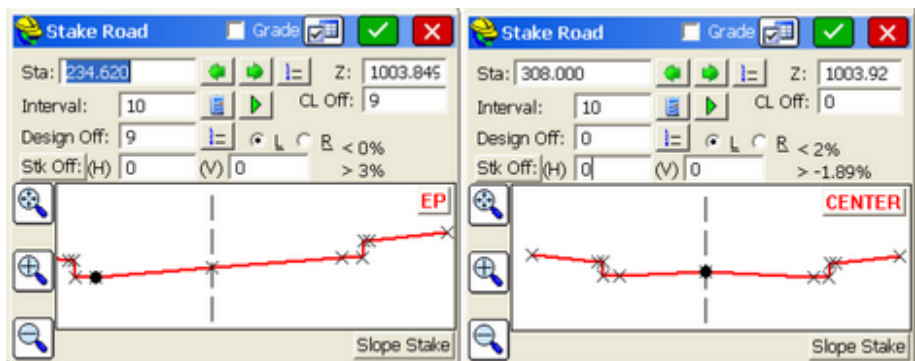

Clicking OK on station 234.62 above would lead to the following stakeout screen, as seen in Plan View (default) and Section View (click Plan/Section in upper left

of screen to switch between views). The button shows current view status.

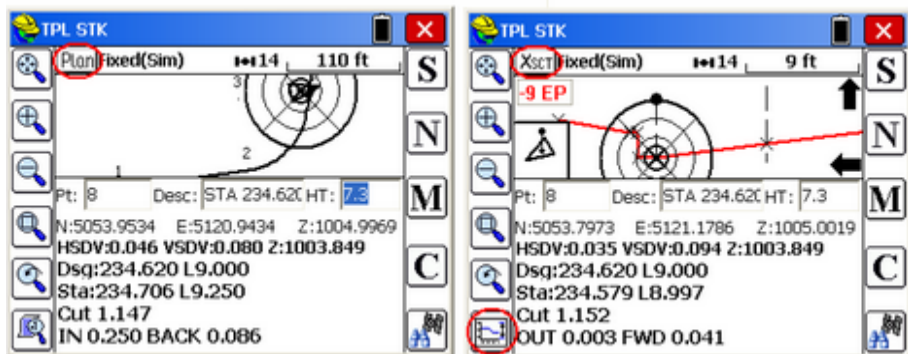

In section view, if the vertical exaggeration is too large, tap the lower left icon (circled in red) and reduce the vertical exaggeration to 1 or 2, real-time, while in the process of staking the point. If the position is within tolerance settings under Equip menu for stakeout, the larger "bullseye" will appear. Note also that using C for Configuration, you can go to the View tab and click on "Use CL for reference object". This means that whenever a horizontal alignment is involved, your instructions will be in the form of forward and back on the alignment, in and out from centerline.

Design File Example--Divided Highway: Divided highways with central ditches (sometimes called "depressed medians") can be defined as templates, starting from the center (ditch or low point) and entering each slope out to the cut and fill. In the example below, there is both an inside shoulder (4%) and outside shoulder (also 4%). The template is shown both inside the editor and through the command Draw Template.

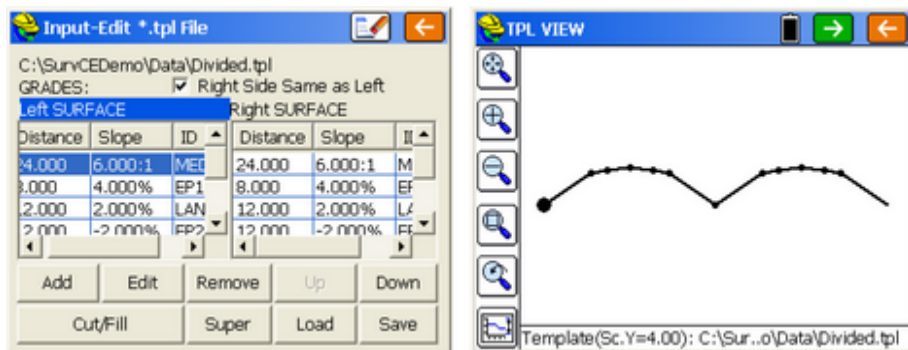

In the Draw Template command, you can Green Arrow to the right and view all template files stored in the current directory of your data collector or PC. This is a way to visually "walk through" all your template files to confirm their appearance.

It is using divided highway style templates where use of the first settings button in

Stake Road is so essential. In almost all cases, the ditch line is not the defined "grade point" of the road. The vertical alignment or profile is typically applied to the inside edge-of-pavement, in this case "EP1". This is accomplished by clicking Settings in the Design Files dialog (circled in red):

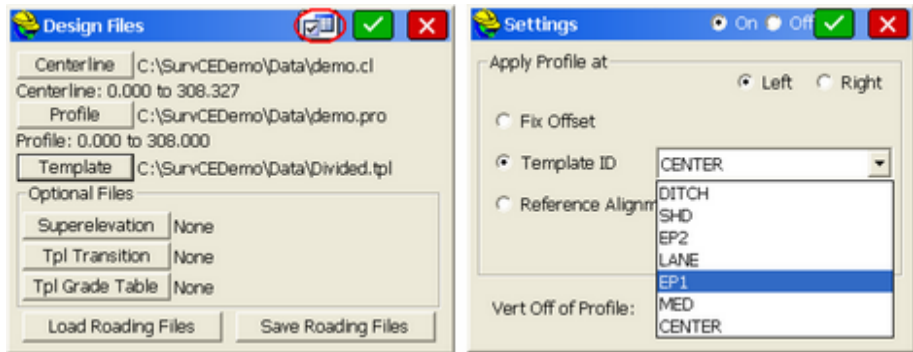

Then if a template ID is the grade point, you can choose it from a droplist. The profile grade can also be applied to a fixed offset (26 feet right for example) or to an entirely different reference alignment (selected as a .cl file). You can specify a vertical offset for the profile as well. So if you defined your template as the subgrade slopes rather than surface slopes, your goal being to stake subgrade, you would need to reference the subgrade to the true profile of the road by entering a vertical offset. The use of the profile offset and reference itself can be turned on and off at the top of the screen. Until the Profile Setting is turned off, Stake Road always passes through the dialog above right to be sure you intend to use the current settings.

So with this setting, and recognizing that the profile grade at station 100 is 1001.00, staking of the centerline ditch or depressed median will result in a recalculated center profile grade of 996.68.

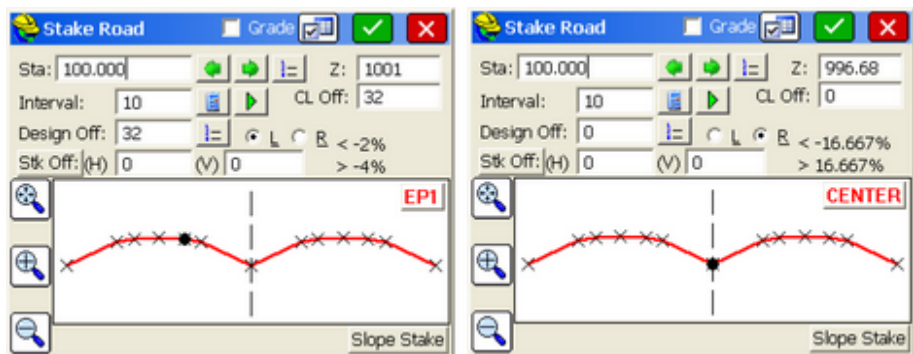

Divided Highways also offer challenges regarding superelevation. When in superelevation, only certain lanes respond and slopes such as shoulders and the inside ditch slopes remain constant. Within Input-Edit Template File, click on "Super" to set the controls for where superelevation applies:

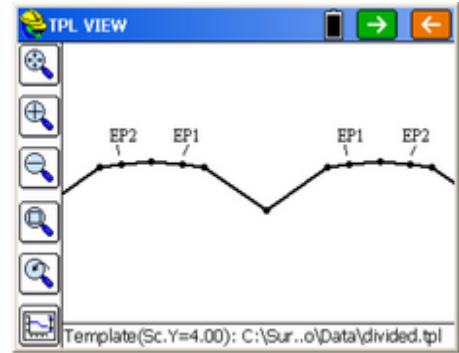
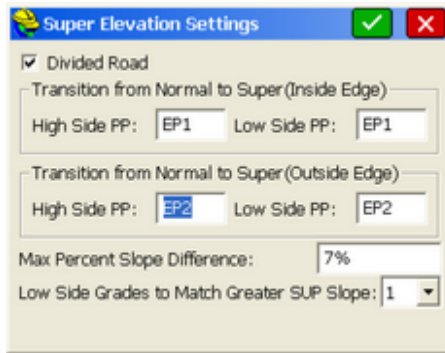

With the above settings, even with superlevation applying to the 2-lane driving surfaces only, the outside and inside shoulders will change if the Maximum Algebraic Difference of the slope percents are more than 7%. So if the normal shoulder is 4%, and the road is in 4% super, then the uphill shoulder of the road at 4% downhill would result in an 8% algebraic difference. Thus a 3% outside shoulder slope will be forced. This prevents "bottoming out" of vehicles as they drive outside the passing lane towards the shoulder in high-side superlevation. Here is an example of this applied in 4% superlevation. Note how the maximum 7% algebraic difference, forcing the shoulder to 3% from normal 4%, applies to both the inside and outside high side lanes.

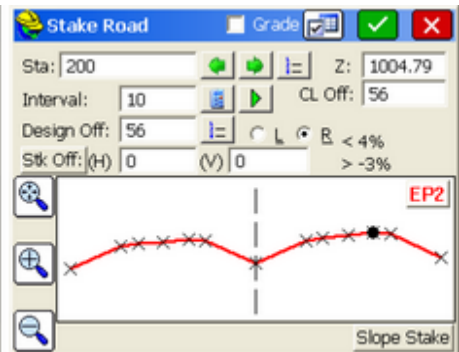
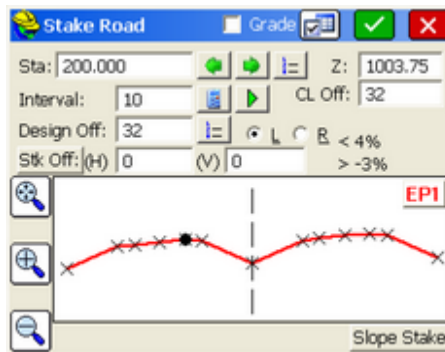

Shown below is a staking of a Horizontal Offset of 4 from the outside right shoulder, extending the shoulder slope to the right on station 210.

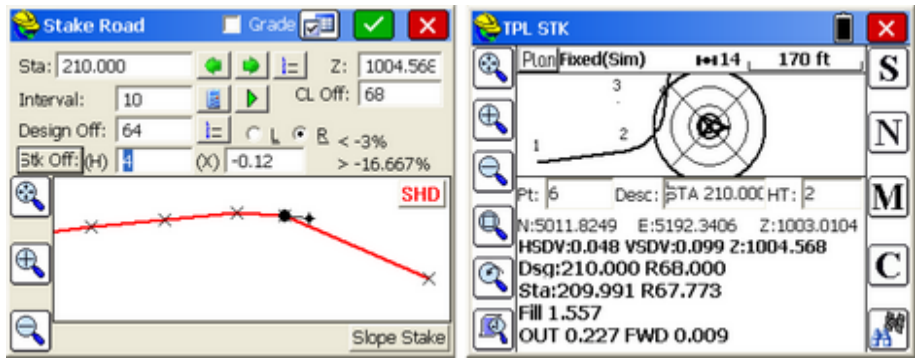

Design File Example with Reduced or Expanded Lane Dimensions using "Template Transition" (.tpt) File: Let's say that starting at station 200, the road shrinks from a width of 10 units on the left side to 6 at station 300. This can be accomplished, per above, by Template Series Files. But there is a file known as a Template Transition File and it is one of the only files requiring Carlson Civil, the Carlson office solution for road design, to make in advance. This is done using the command "Template Transition" under the Roads pulldown of Carlson Civil. The stations need to be entered in increasing order for start transition, Full Template (complete transition), and end Full Template and resume normal template. If there is no resumption of normal template, enter stations beyond the job range.

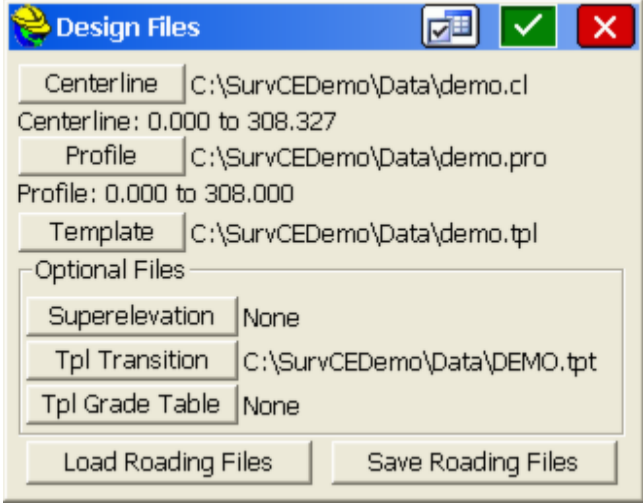

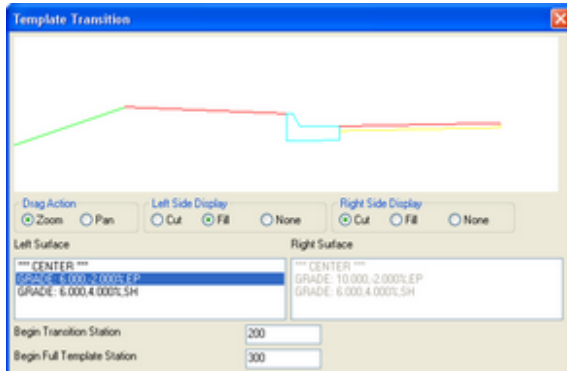

Note that at station 300, the full EP position is at Design Offset 6, based on the DEMO template transition file (DEMO.TPT). At station 250, the EP lane would be 8 units wide, halfway between normal 10 at station 200 and the reduced with of 6 at station 300. The Template Transition File is a relatively crude method compared to others and can be considered a "legacy" feature reading Carlson Civil ".tpt" files. The expansion or contraction of road lanes, with the greater flexibility of both maintaining AND altering cross slopes, can be accomplished with Template Series Files (described in Superelevation example above) and with Template Grade Table Files, described next.

Design File Example with Template Grade Table File: The same example using Template Series File, where the Demo.tpl road is transitioned through 4% superelevation and a lane width change, left side from 10 to 8, can be accomplished identically using a Template Grade Table. The Template Grade Table takes a single template and associates specific lane width and slopes with any specified template ID point, left or right. This method has the ultimate flexibility for controlling road designs. Although described in the section on Road, Utilities, here is the above example accomplished using the Template Grade Table.

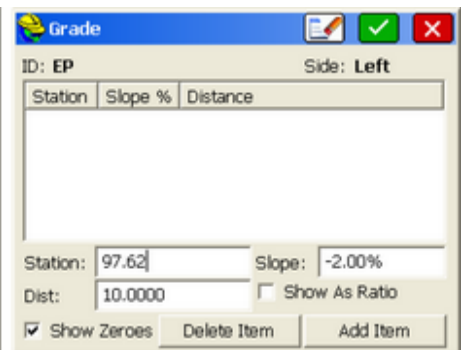
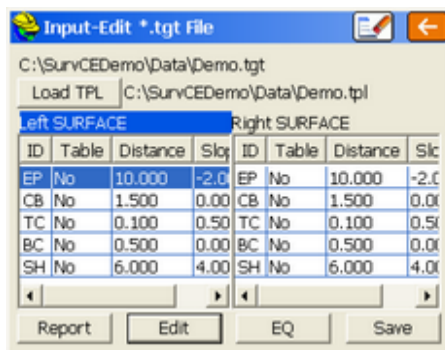

You start by selecting the grade that will change. In this case, both the EP Left and the EP Right grades will be impacted by superelevation and lane width changes. So you can start by selecting EP Left. You next enter the station where the continuous transition from normal EP Left grade/slope to a different EP Left

grade/slope occurs. The last station where 10 width at -2% occurs is reverse crown (2% all the way across) or 97.62. Enter that data and then click "Add Item". The next station controlling the transitional slopes on the left side would be full superelevation (-4%) at station 127.62. Continue entering the data as shown below left. The left EP lane holds -2% slope and 8 width through the end starting at 249.62, so no final station needs to be entered. For the left side, only 4 stations, as shown, control all the EP transitions.

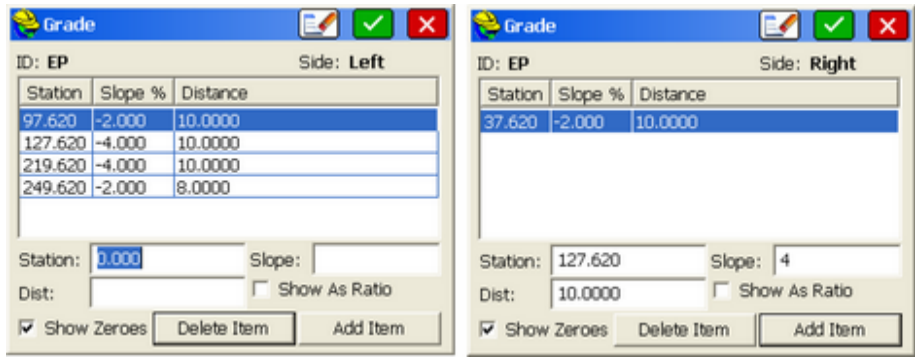

Turning attention to the right side, or "high side" in the superlevation caused by a curve to the left, the transition out of normal crown begins at station 37.62. So this must be entered as the last "normal" width/slope station for the EP Right. Then the next controlling station is all the way to the full super at 127.62, since the rate of transition is consistent in this example (2% over each 30 length of road). The right side would have slope 0% at 67.62, +2% at 97.62 and +4% at 127.62 as shown, so only the latter, controlling station data needs to be entered. Complete the entire data for the right side EP as shown below left:

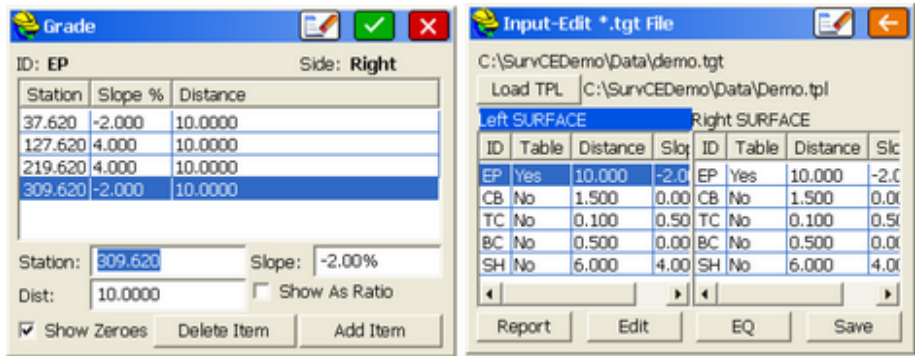

When both EP Left and Right sides are edited, they are marked "Yes" in the Template Grade Table dialog, indicating those template IDs have distinct grade tables. (If, for example, a shoulder dimension was expanded on the right side, it could have its own Grade Table). Note how different the left side EP data is from the right side EP data--the pivot points for grade changes are different in each case, only identical at the shared full superelevation stations. If the station for the left EP lane width change was different than the precise "reverse crown" station,

then a new and separate station would be entered controlling only that lane transition point. Template Grade Tables are ideal for transitioning road rehabilitation projects to existing, undisturbed, as-built road template dimensions and slopes.

Clicking Report in the Template Grade Table routine leads to the presentation at lower right. Now to apply the Demo.tgt Template Grade Table File, add it as an "optional" file in the Stake Road, Design File option. Click OK to proceed.

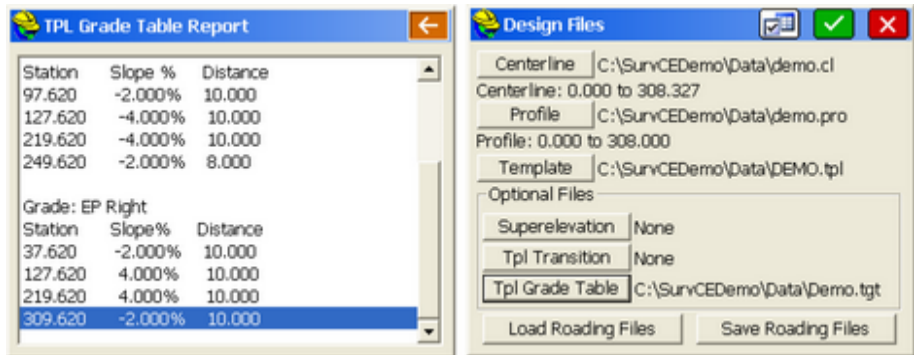

Note 8 dimension of EP lane width on station 280 when EP Left is clicked on the screen, and when the Center point is clicked, the right lane appears in slope transition downward from full super (at 0.1% uphill grade, nearly flat). Experimenting with different stations or clicking the green arrow "drive through" button both help verify the accuracy of the Template Grade Table entries. It is important to point out that the Design File method allows templates to be adjusted 3 distinct ways: (1) acted on by superelevation (.sup) and lane transition (.tpt) files, (2) transitioned from one template to another with the Template Series File and (3) modified by a Template Grade Table file. The "Cut from Alignments" and Road Model options discussed below may be considered a fourth way, where template ID points can be assigned their own centerlines and profiles, as read from the drawing, directly assigned, or loaded from a LandXML file (Road Model method).

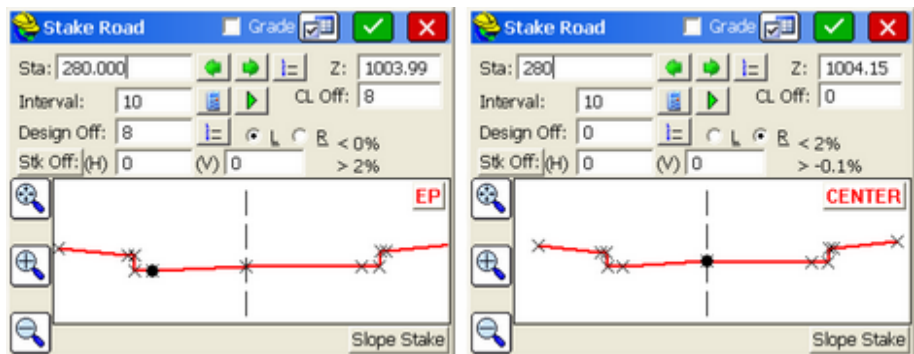

Section File Method

Section File Example with Multiple Sections and Longitudinal Pipes: For complicated roads, the cross section data, provided at intervals and key stations on the alignment, is very often the "official" design data for purposes of construction. Staking out cross sections according to the plans, therefore, is standard operating procedure in road construction stakeout. The challenge is often obtaining the cross section data. Sometimes it is available in LandXML format, which SurvCE can read within Road, Utilities. It may also be available in a Columnar Text format, which SurvCE also reads. As a last resort, cross section data can be hand entered to form the SurvCE ".sct" file, using the command Input-Edit Section File within Road, Utilities. There is a special format for Longitudinal Pipe Data that can be read automatically by SurvCE. This format, including the header line, is as follows (the "+" in the stationing is optional):

```

STA,Offset,FL elev.,Link - ID,Link - Library Item,Type
13+00.00,52.13,22.32,NP-26,18" RCP,T
14+00.00,-47.61,22.08,NP-1,18" CMP,T
14+00.00,49.63,22.02,NP-26,18" RCP,T
15+00.00,-39.58,21.78,NP-1,18" CMP,T

```

The 18" RCP (reinforced concrete pipe), for example, is found at station 13+00 at offset 52.13, flow line elevation (invert) of 22.32, Type 18" RCP and again at station 14+00, offset 49.63, flow line elevation of 22.02. The "Link-ID" column tracks the pipe ID from station to station, and the Link-Library Item is used to confirm the linked pipe and for purposes of display. The final column is used as a pipe designation and should be included. Longitudinal pipe data can also be entered directly within Input-Edit Section File as shown below. Note that the pipe size and name comes first in the description. When importing from an ASCII File, the Link - Library Item is found and sorted such that it goes first in the description field.

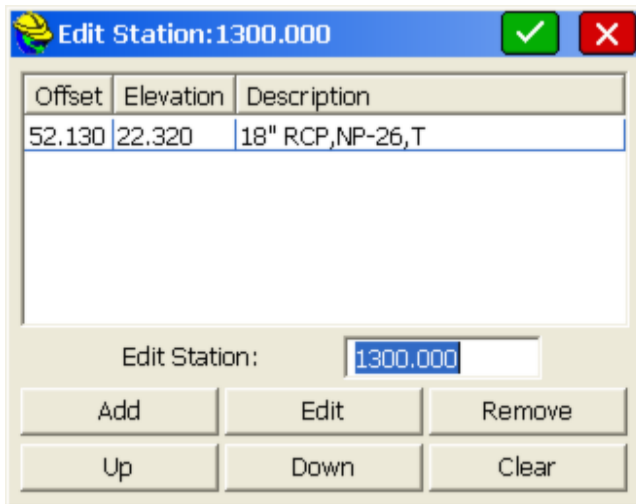

Multiple cross section files can be loaded by the option "Add Section" in the

opening dialog of the Section option within Stake Road, Section Tab. You can Delete Sections from the list, and you can assign a Layer to the Sections.

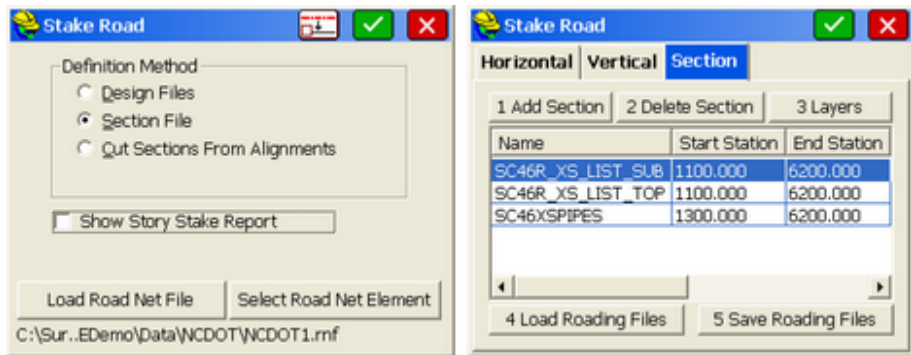

The Horizontal and Vertical Tabs are similar to those in Stake Line/Arc. The Horizontal Alignment (whether loaded as a ".cl" file or picked from the screen) MUST be selected. The Vertical Alignment is optional, but for roads with high and low points, the vertical alignment is necessary to interpolate sections correctly when these high and low points or grade changes on the road profile, fall within the station interval. For example, if cross sections were available at a 50-foot interval, but there was a high point at station 17+75, the vertical alignment would be critical for accurate interpolation of station 17+75. You have the option to apply the vertical alignment or work strictly with the cross sections.

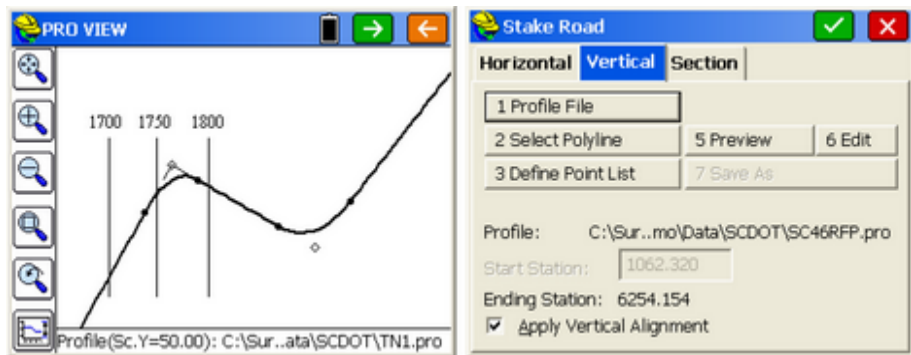

When you click OK (green check), you proceed to the Section Selection screen. Here you can select in the lower portion of the dialog which surface or sections to stake out. All break points on each selected surface appear. If a pipe is selected, its data appears in the upper right. If the cross sections did not contain descriptions, then only the design offset appears in the dialog, along with the slopes left and right of the selected point. You can pick the points to stakeout graphically on the screen.

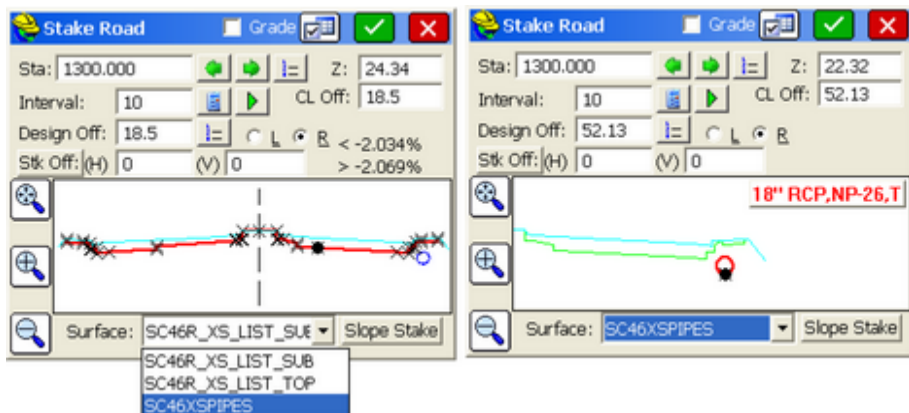

The selected or highlighted cross section surface always appears red and bold for purposes of stakeout. The Settings button at the top of the screen leads to the standard Road Stakeout settings controls, also found in Job Settings, Stake tab.

Section File with Reference Point in Stake Road (For 2 Cut/Fill Results)

The staking of pipes offers a convenient point to introduce the topic of the Road Stake Reference Point. If you click the "FromList" button opposite the Design Offset within Stake Road, you are taken to a special list, that offers the ability not just to select the offset and elevation to stake, but to pick a section surface and a reference point on that section to use for stakeout. In this case, we selected the 2nd from left offset point, top of the fill slope, and then clicked "Set REF". This expands the information on the screen to include the reference point offset, to show that point as a black symbol with solid circle inside, along with the target point, in this case the 18" CMP pipe at station 1400.

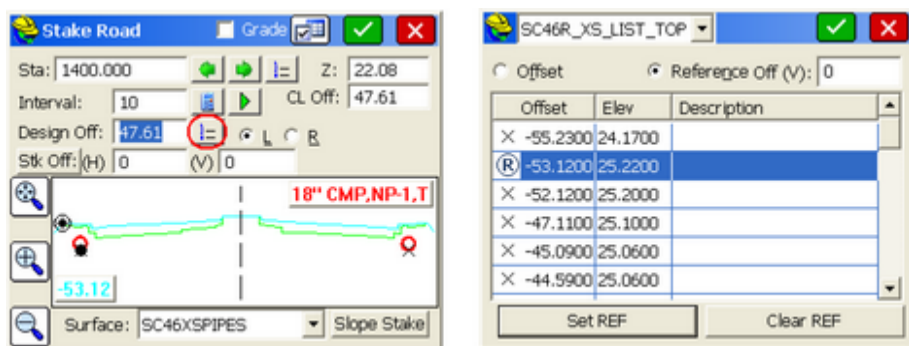

Now when you click OK (green check) to proceed, additional information is presented on the screen during the stakeout process.

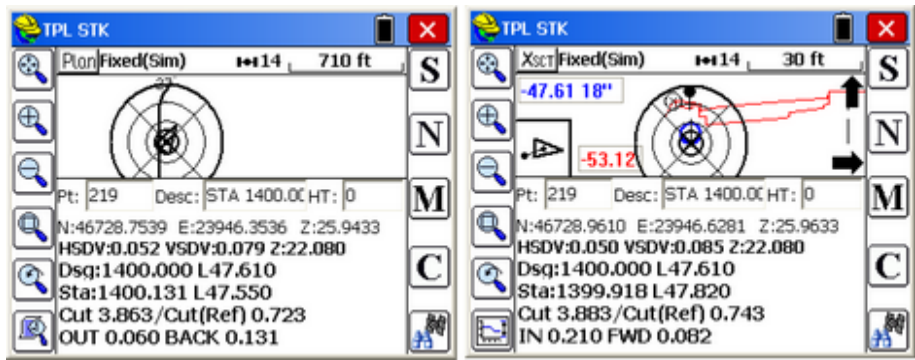

With reference points, the in-out and forward-back guidance is to the target point, but the cut and fill information is provided to both the target AND the reference point. Since the pipe target point is well below the top of bank reference point, cut to the reference in this example is just 0.7 approximately while cut to the pipe is 3.9 approximately. A single stake marking the pipe could show the cut to the shoulder as well. If the reference were reversed, you could stake the shoulder point and also reference the cut to the pipe as additional information to mark on the stake. Options to show North/East or Station/Offset are provided in the Stakeout Report.

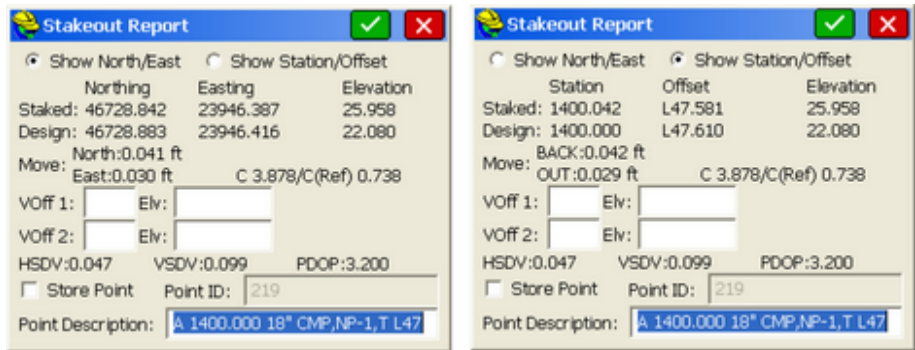

Be sure to clear the Reference Point so it does not stay active.

Section File with Story Stake for ALL Cut/Fills to all Break Points: When staking out cross sections, it is beneficial to turn on "Show Story Stake Report". Whereas the Reference Point method outlined above provides 2 cut/fill values, the Story Stake provides All Cut/Fill values and is easy to use. The one advantage of the Reference Point method is that the reference can be on a different cross section surface. Regarding the Story Stake, set it on in the opening screen. Then choose a point on a surface with many break points to stake out.

When the point is staked, the initial report screen shows the individual cut fill to the selected point:

Stakeout Report ✓ ✕

Show North/East Show Station/Offset

Station	Offset	Elevation
Staked: 1399.996	L53.122	25.954
Design: 1400.000	L53.120	25.220

Move: FWD:0.004 ft
 IN:0.002 ft Cut 0.734

VOff 1: Elv:
 VOff 2: Elv:

HSDV:0.047 VSDV:0.101 PDOP:3.200

Store Point Point ID:

Point Description:

When you click OK with Story Stake turned on, you obtain both Progressive and Total numbers for the entire list of offsets for the cross section up to Center (entire left side in this case). And if you turned off "Report to Center", you would get a cut/fill report for all offsets on the entire cross sections, from the single staked point.

Offset Point Report ✓

Progressive Total
 Show Report Up to CENTER

Offset PT Sta: Offset: Elevation:
 1400.000 L53.122 25.954

	HDIST	VDIST	SLOPE
55.23 to 53.12	2.11	1.05	FILL 49.8% 2.0:1
55.23 to 52.12	1.00	0.02	CUT 2.0% 50.0:1
55.23 to 47.11	5.01	0.10	CUT 2.0% 50.1:1
55.23 to 45.09	2.02	0.04	CUT 2.0% 50.5:1
55.23 to 44.59	0.50	0.00	FILL 0.0% 999.9:1
55.23 to 44.51	0.08	0.50	CUT 625.0% 0.2:1

Offset Point Report ✓

Progressive Total
 Show Report Up to CENTER

Offset PT Sta: Offset: Elevation:
 1400.000 L53.122 25.954

	HDIST	VDIST	SLOPE
OFFSET to 55.23	2.11	1.78	CUT 84.6% 1.0:1
OFFSET to 53.12	0.00	0.73	CUT 999.9% 0.2:1
OFFSET to 52.12	1.00	0.75	CUT 75.2% 1.0:1
OFFSET to 47.11	6.01	0.85	CUT 14.2% 7.0:1
OFFSET to 45.09	8.03	0.89	CUT 11.1% 9.0:1
OFFSET to 44.59	8.53	0.89	CUT 10.5% 9.0:1

Note that the Progressive Report shows the relative vertical distances between offset points, and does not utilize the field-staked elevation in the vertical calculation. But on the Total Report, the vertical difference is from the staked position to each of the offsets. Study the 4th column for the direction of the vertical difference as cut or fill.

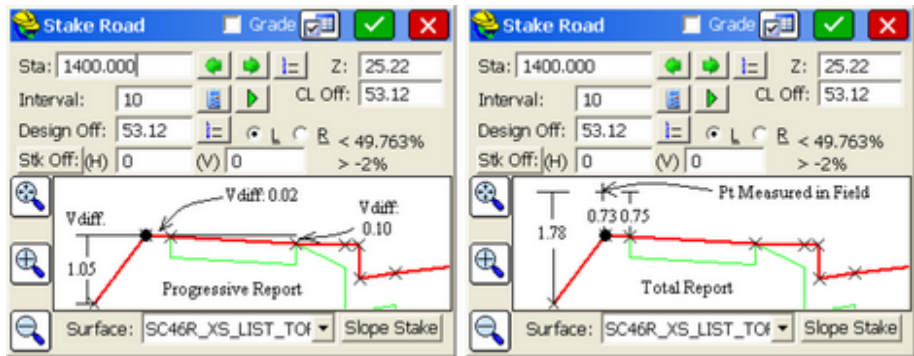

This report can also be saved to a user-formatted cutsheet file. Later in the Stake Road documentation, formatting of Story Stake cutsheets are discussed.

Section File Method using RNF Files from Carlson Civil, Road Network:

Carlson Civil will output complete stakeout files in the form of "RNF" files as both Design Files and Section Files to stake all portions of road networks, including intersections and cul-de-sacs. Shown below is a road, viewed in 3D, designed in the Carlson Civil Road Networks command, including the option within Settings, Output Options tab, that produces the named ".mf" file (Road Network File).

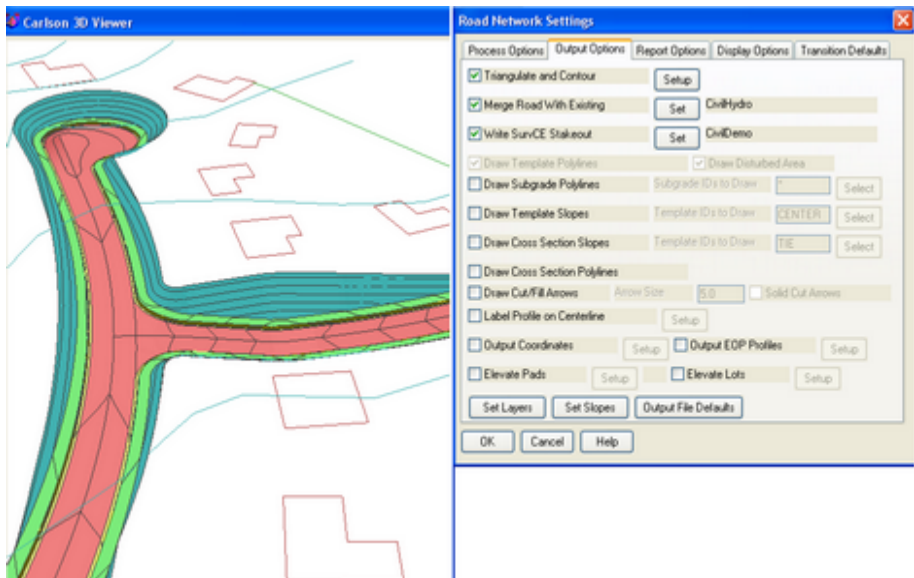

It is recommended that the RNF files be staked out using the Sections options within Stake Road--since all surfaces can be viewed and selected (eg. surface of road, shoulder and cut/fill slopes, plus all subgrades). The Section Method offers the flexibility to select any desired Road Net Element for stakeout, as output in the form of the RNF file. To use the command, select the RNF file at the lower left of the opening dialog, then select the Road Net Element to stake, either

graphically as shown or from the pulldown list. In the above road example, there are 6 elements, named according to the centerline files involved: (1) First Part Main Road (2) Second Part Main Road after Intersection, (3) Side Road, (4) First Curb Return Main Road to Side Road, (5) Second Curb Return Side Road back to Main Road and (6) the Cul-de-Sac.

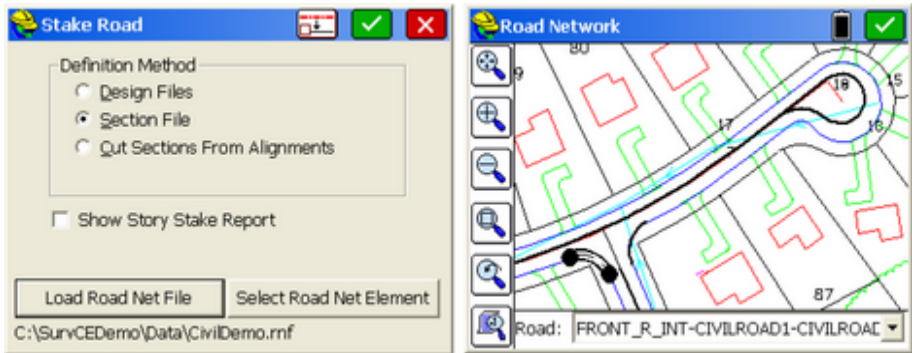

If is our goal to stake the back of curb on the first "Curb Return" as shown, then select it and choose the top surface and pick the back of curb point. If you pick "From List" for the Stations, you can review the entire station range for this small curb return, which in this case is 45.96 as shown below right. So staking Station 24 on this special segment would be approximately halfway around the curb return. Note the "centerline" used for this is the edge-of-pavement or left-most point on the curb, so that the back of curb appears as CL Offset 1.5 (curb is 1.5 units wide).

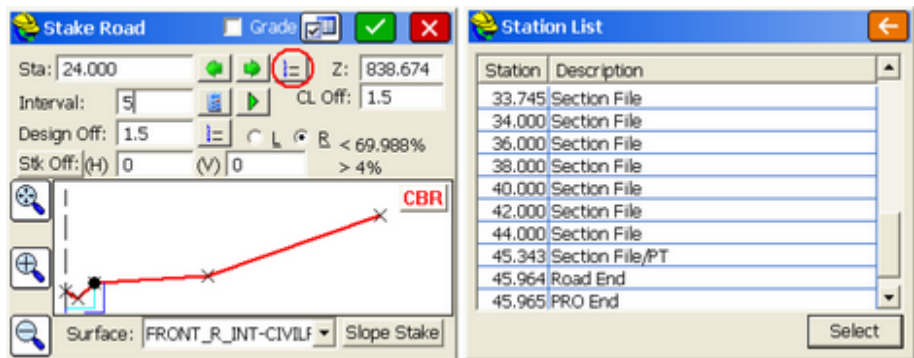

Note how any surface or subgrade point can be selected and staked out, at any distance along the special "centerline" for this curb return segment. The next procedure is to click OK to continue, to enter the stakeout screen, shown below in both plan view and cross section view.

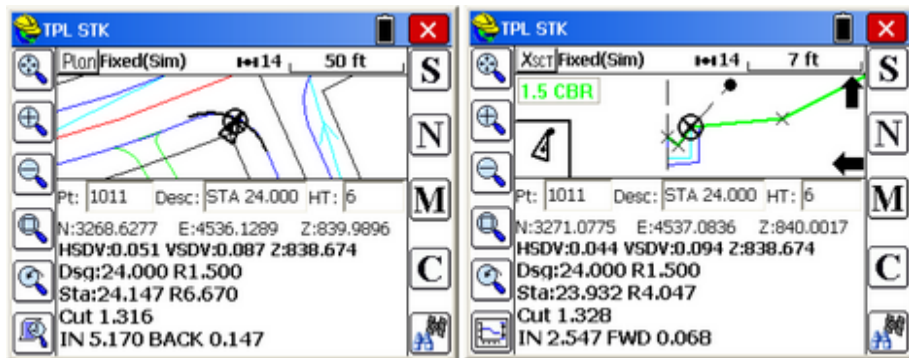

The process can be repeated for the cul-de-sac. Here we will stake out both the stone subgrade outside point and then we will slope stake the catch at a station approximately 1/4 of the distance around the cul-de-sac:

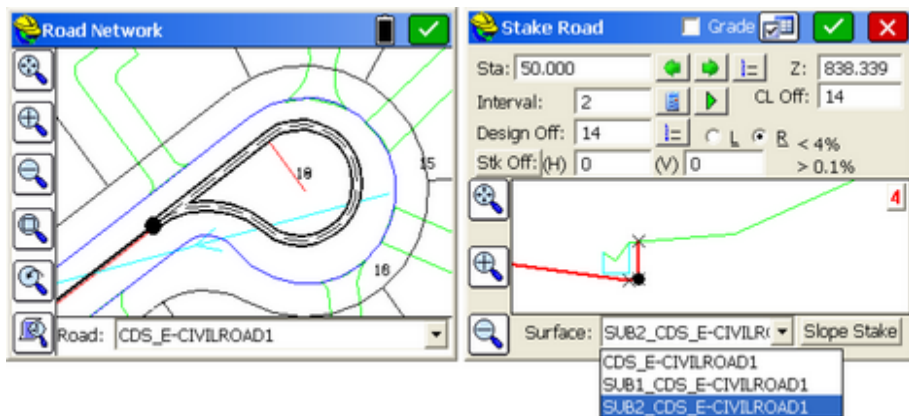

The cul-de-sac "centerline" is the outside edge-of-pavement facing the curb, and by clicking "From List" opposite Station, is seen to be just over 200 in total length in the screen below left. Staking out station 50 would be approximately 1/4 of the distance around the cul-de-sac.

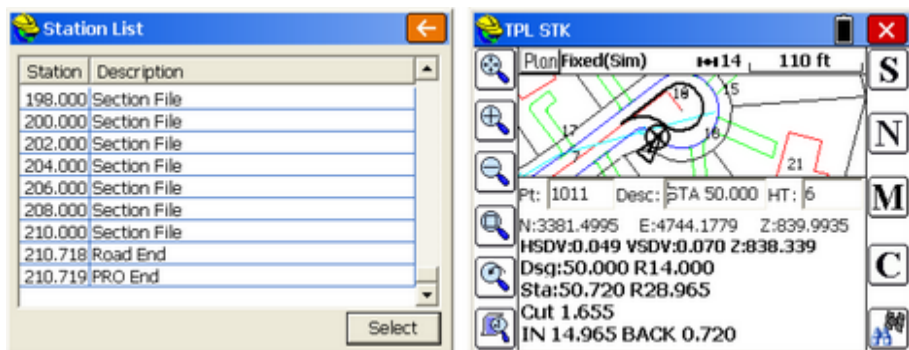

The "catch" point at the top of cut can be staked out for station 50 by selecting the top surface outside shoulder point and then clicking the Slope Stake button in the lower right of the screen:

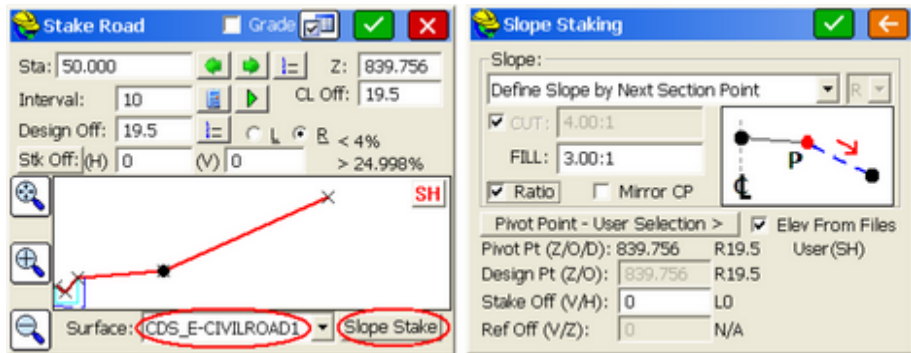

Slope Staking takes you to a "parameter" dialog where you set the Pivot Point type (here it is "User Selection") and how the next slope is defined. By selecting "Define Slope by Next Section Point", the program detects that point is in cut, so calculates the cut upslope at 4:1 (matching the >25% at left) and ghosts the value so it cannot be changed. You can also change the selection type to "User Defined" and enter any cut upslope ratio you prefer. Then click the Green Check (OK) to continue:

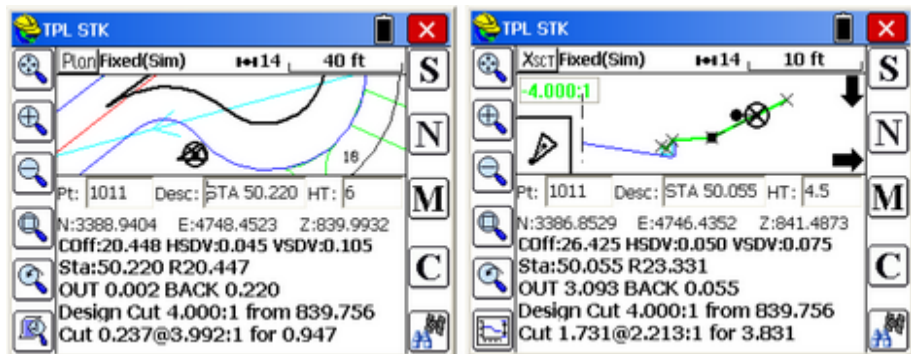

Note that with a rod height of 4.5 in this simulated example above right, the ground catch position is projected at lower than the original estimate further to the right. This is often the case in slope staking--the ground has been altered since the design was conducted and you must react to actual field conditions. It should also be noted that the Slope Stake command "models" the existing ground real-time as you move, making the best estimate it can of the projected or interpolated catch point position. Since it works real time with GPS without taking a measurement (as required with a total station), it is best to keep the base of the pole close to the ground. Slope Staking leads to the Slope Reports shown below:

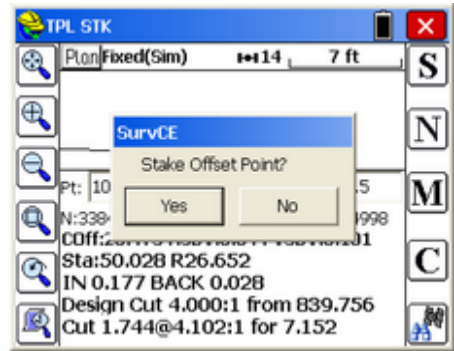

It is recommended whenever doing Slope Staking to stake the first Offset Point, in case the actual catch point stake is knocked out during construction. Typically click Yes to the above prompt, "Stake Offset Point?" Use the "Delta Distance" option.

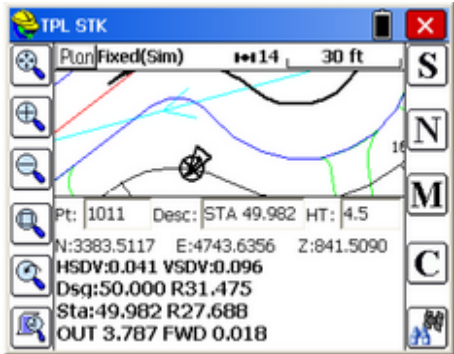
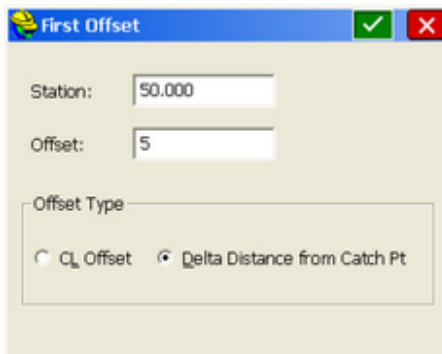

When the offset stake is placed, you can do a second offset. This is sometimes beneficial in extremely small radius curves, such as a cul-de-sac, in order to have 2 stakes to point in the direction of the true catch point. But in most cases it is unnecessary. The slope stake report is shown below:

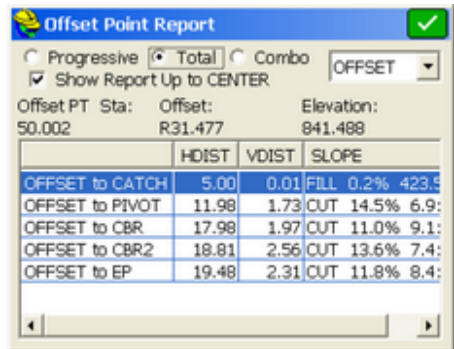
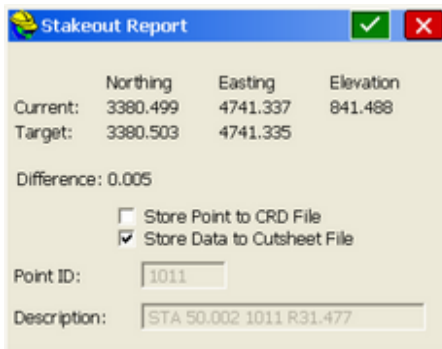

The "Combo" option shows a "progressive", incremental slope ratio for each segment (last column), combined with a total HDist and VDist measurement to

each point. If you have named and defined a Slope Stake file in advance (File, Job Settings, Stake Tab), and clicked it on for storage, then the slope stake information will be stored in the slope stake file as shown below. The file formats of all of these "cutsheet" types are fully user configurable. A configurable Story Stake Report is outlined later in this chapter.

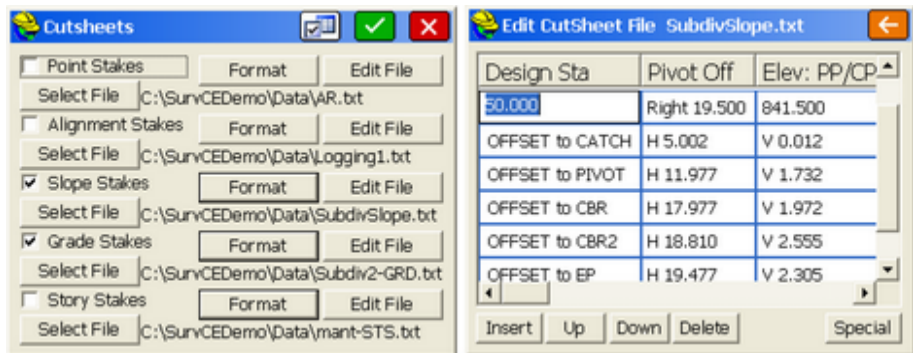

Cut from Alignments Method

If a drawing or DXF file is loaded or created in SurvCE using CAD tools in the Map screen or by Field-to-Finish, 3D Polylines and 2D Polyline Contours can be used to extract cross sections for stakeout. This is the "Cut from Alignments" option. The normal use of this command is to extract sections from a set of 3D Polylines representing pavement, shoulder, and ditch lines. However, it is possible to actually name the alignments by associating section descriptions with selected centerline (.cl) and profile (.pro) files. In normal use, when extracting sections from a drawing of 3D polylines, the layers of the polylines are used as the section point description. If several polylines are encountered with the same layer name, such as Ditch, then in the direction away from centerline, each subsequent common layer is given an appended number incremented by 1, as in Ditch, Ditch1, Ditch2, to create unique section point descriptions.

Consider the drawing of 3D polylines shown below. In close-up, stationing for the main horizontal alignment (centerline) appears, with a starting station computed to be 219+00.

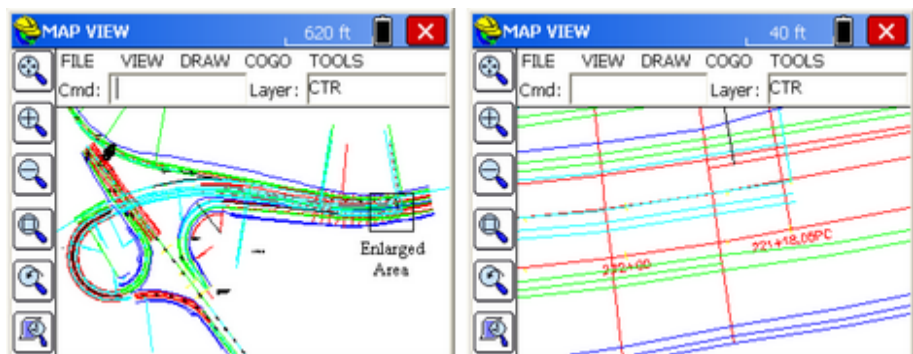

So within Stake Road, selectd option 3, Cut Sections from Alignments. This leads to the standard alignment selection dialog, with tabs for Horizontal and Vertical Alignments. It is essential to set a Horizontal Alignment. Pick the main centerline (labeled with 221+18.05 PC above).

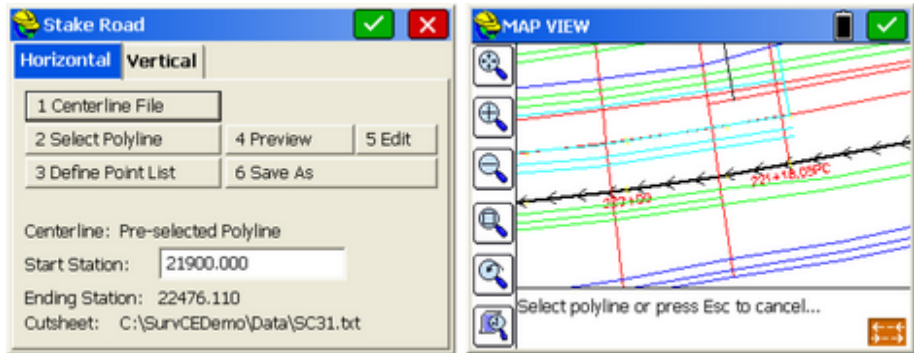

If you are unsure of the direction of the main centerline, pick the orange "Direction Reverse" button. If it was correct to begin with, you will need to reverse again to restore the original direction. It is important to point out that all polylines that will be selected for cross sectioning need to be drawn in the same direction. So prior to issuing the Cut from Alignments command, it is a good idea to go to the Map screen and study the polylines involved using the command Draw, Modify, Reverse Polyline. In the above example, all polylines for road, shoulder, ditch and other points need to be drawn and saved right to left, matching the main centerline. When selecting the main centerline, if it is 3D, you will be asked, Overwrite the Vertical Alignment? Answer with Yes. Set the correct Start Station, in this case, 21900 (verify same start station for vertical alignment). Then Ok (green check) to continue.

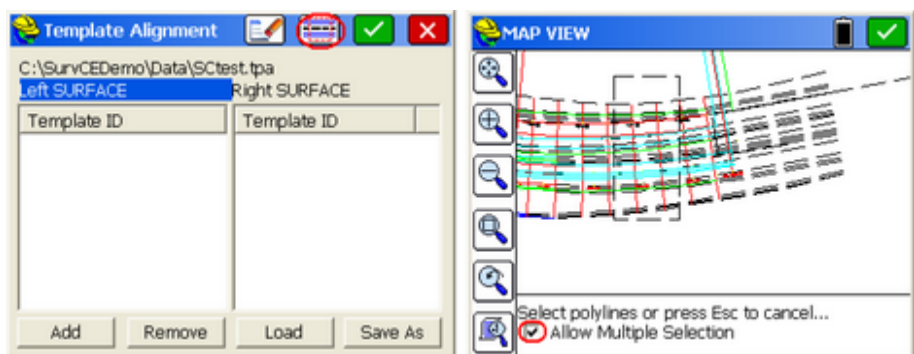

If there is previous data in the 2-column screen, use the Eraser Icon to delete all the data. Then rather than pick one polyline at a time, use the window/crossing selection icon circled in red above left. This leads immediately to a map screen as shown above right. In the lower portion of the dialog, click on "Allow Multiple Selection". Then do any combination of individual picks or window/crossing

selections (lower left to upper right or lower right to upper left). A typical selection is shown by the dashed rectangle above. Click OK to return to the Template Alignment dialog, which now has the data organized in 2 columns:

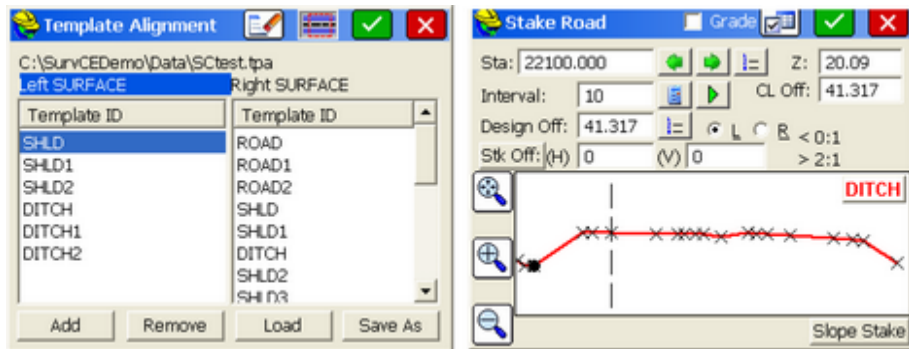

Note that when picking the first ditch point left side, that the layer is Ditch, and the next two are layered Ditch1 and Ditch2. Above the select Ditch point to the right is the third shoulder point on the left side, with SHLD2 as the ID. The next step is simply to click OK (green check) and start the normal stakeout process. Note also that you can Slope Stake (typically from the outer ditch point on the trapezoidal ditch, Ditch1 in this case).

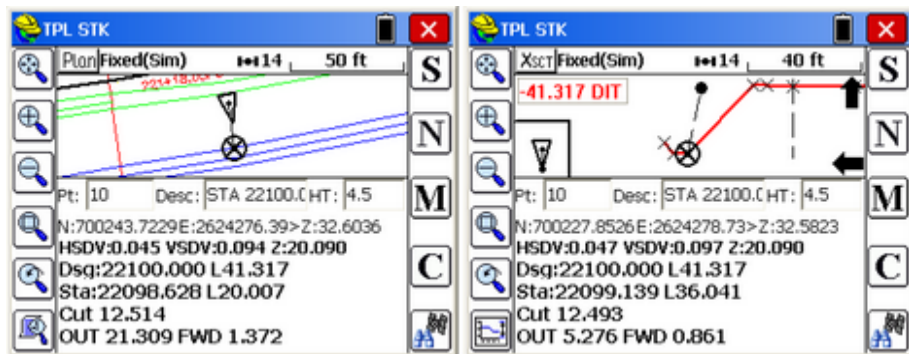

It should also be noted that on most data collectors with up and down arrows, the 6 lines of cut and fill reporting can be reduced by using the down arrow key. Tapping the up arrow key restores the full 6-line display. (In PC Simulation, use F2 to minimize and F3 to restore the 6 lines). This works in both plan view and section view. You can also drag the graphic display down and back up with a press and hold on the lower graphic window border. This is a little more difficult as the selection of the press and hold must be relatively precise, since normal press, hold and move impressions in the graphic area are interpreted as the pan command.

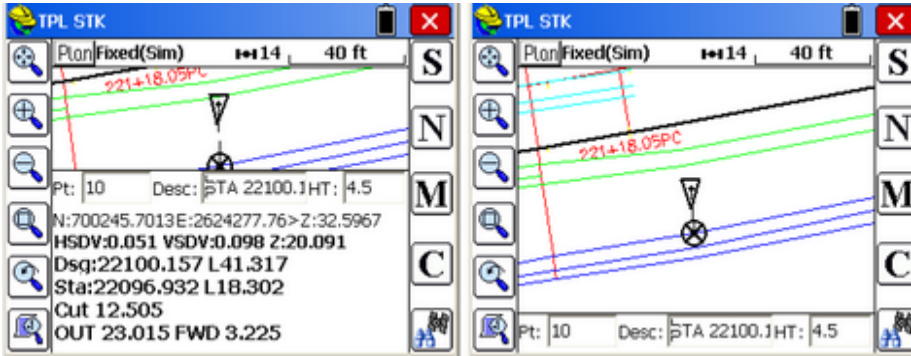

The amount of reduction in text and expansion of graphics is dependent on View Settings. To shortcut to View Settings, tap C for Configuration (or the Tools icon for Configuration) and select the View tab shown below. The above right mode is Collapse Mode "None". Below, Collapse Mode "Navigate Data" is shown, which is 2 lines. The position mode is also 2 lines and shows the x,y,z coordinates of the triangle (your position in the field). The PCDemo version of SurvCE can be expanded and collapsed, according to the Collapsed Report setting, using F2 to shrink and F3 to expand.

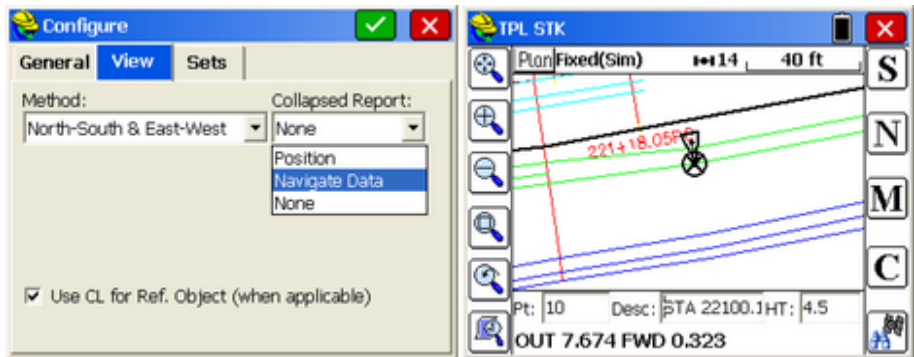

The Cut from Alignments method also allows use of the "Add" button to individually assign a centerline and profile to section points, but this method is tedious and rarely applies, compared to the method of selecting 3D polylines by pick and window/crossing selection from entities on the screen.

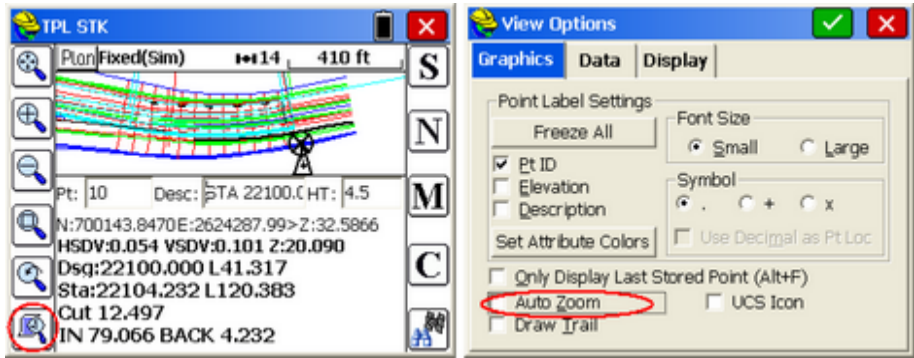

When "Auto Zoom" is clicked on, the program zooms closely as the target is approached, leading to the bullseye (which appears whenever the target is within the Stakeout Tolerance set within Equip Menu, Tolerances).

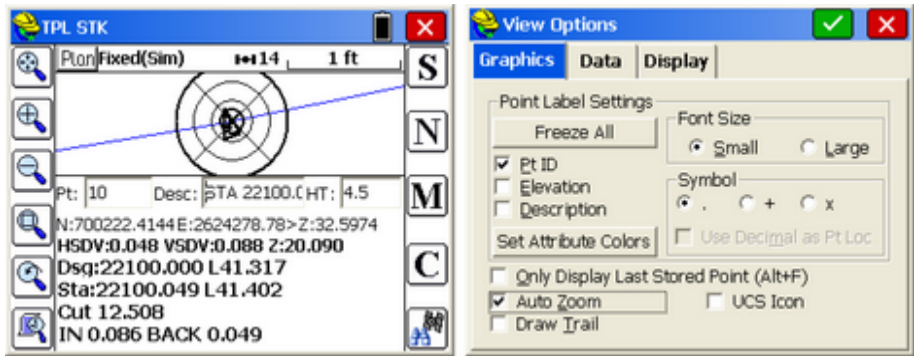

The "Story Stake" information would appear as shown below (Progressive and Total options). By staking Section ID "Ditch", there are 2 Ditch ID points to the left and 2 shoulder and 1 Center point to the right, up to the selected centerline. If "Show Report up to Center" is turned off (in effect, show ENTIRE report), then a much more complete report would appear providing offset information to all section points on both the left side and right side of the road.

Offset Point Report				
<input checked="" type="radio"/> Progressive <input type="radio"/> Total <input checked="" type="checkbox"/> Show Report Up to CENTER				
Offset PT Sta:	Offset:	Elevation:		
22100.000	L41.250	32.599		
	HDIST	VDIST	SLOPE	
DITCH2 to DITCH1	3.88	1.94	CUT 50.0% 2.0	
DITCH1 to DITCH	5.00	0.00	FILL 0.0% 999.5	
DITCH to OFFSET	0.07	12.51	FILL 999.9% 0.0	
OFFSET to SHLD2	25.75	0.40	FILL 1.5% 64.6	
SHLD2 to SHLD1	5.50	0.04	CUT 0.7% 139.6	
SHLD1 to CENTER	10.00	0.07	CUT 0.7% 143.5	

Offset Point Report				
<input type="radio"/> Progressive <input checked="" type="radio"/> Total <input checked="" type="checkbox"/> Show Report Up to CENTER				
Offset PT Sta:	Offset:	Elevation:		
22100.000	L41.250	32.599		
	HDIST	VDIST	SLOPE	
OFFSET to DITCH2	8.95	10.57	CUT 118.1% 0	
OFFSET to DITCH1	5.07	12.51	CUT 246.9% 0	
OFFSET to DITCH	0.07	12.51	CUT 999.9% 0	
OFFSET to SHLD2	25.75	0.40	FILL 1.5% 64.6	
OFFSET to SHLD1	31.25	0.36	FILL 1.2% 86.5	
OFFSET to CENTER	41.25	0.29	FILL 0.7% 142.	

Road Model

The LandXML Road Model, when loaded, requires selection of a main horizontal and vertical alignment. The routine then processes similar to Cut from Alignments, described above. The LandXML format for road design files is widely recognized around the world as the accepted form of file sharing. Carlson Software is the principle sponsor of LandXML.org beginning in 2014. In Scandinavia, for example, roads are often defined by a series of horizontal and vertical alignment "pairs" for each road breakline (edge-of-pavement, shoulder, etc.) and a single file can contain multiple roads, and all surfaces of each road (top, subgrade1, subgrade2, etc.). As an example, a portion of an actual LandXML file might appear as shown here, which includes the road name "316" in this case:

```

</Project>
- <Alignmentsname="316">
- <Alignmentname="316" length="971.597307" staStart="
0.000000">
- <CoordGeom>
- <Linelength="27.309619" staStart="0.000000">
  <Start>6581158.362094 151616.365550</Start>
  <End>6581180.578173 151632.248280</End>
</Line>
- <Spirallength="35.731361" staStart="27.309619" rot="ccw"
spiType="clothoid" radiusEnd="600.000000" radiusStart="INF"
constant="146.420">
  <Start>6581180.578173 151632.248280</Start>
  <PI>6581199.957122 151646.102688</PI>
  <End>6581209.848914 151652.738602</End>
  Etc.

```

When the LandXML file is loaded, all the roads appear in a list, along with all subgrades.

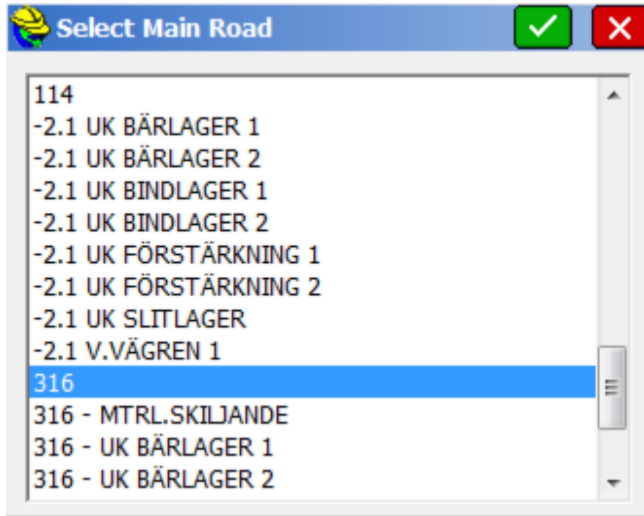

You then select any road to stake out, such as "316" in this example. Within the selected road, you can pick any surface (much like in the Cross Section method) and any point on the surface. If available, the description of the selected surface point is shown:

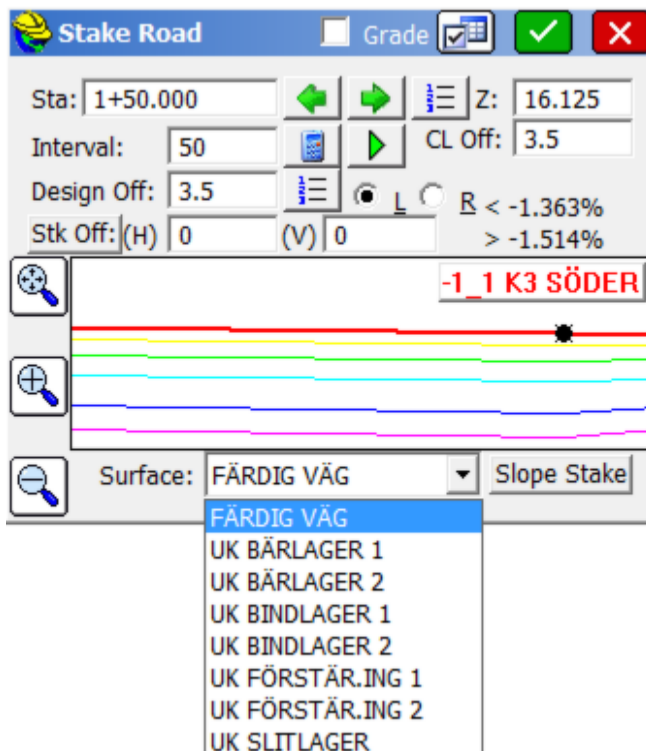

Interpolation

If descriptions are provided, “intelligent” interpolation is performed between similar descriptions on slope transitions or widening lanes as well as vertical curves for all methods described above.

Stake Road Screen (Common to All Methods)

This screen is the heart of the program. Here is where you select the station and offset to stake out. You can even launch into a slope stake and then return to stake out other template points.

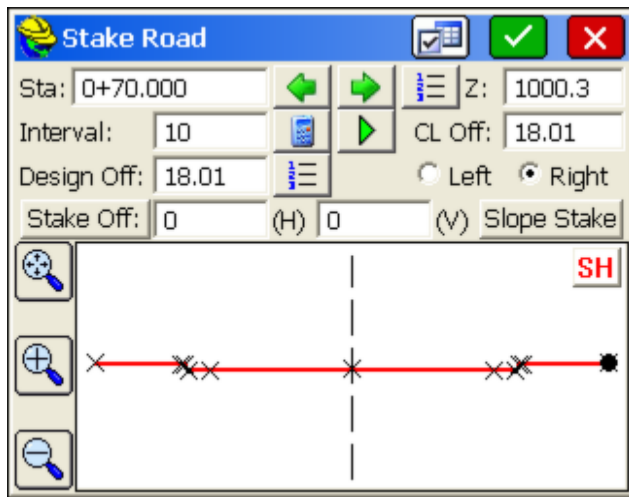

- Settings:** The “Additional Stake Stations” that appear in the List are set in the lower portion of the dialog. The Vertical Scale option will allow for “exaggeration” of the vertical on the template graphic. Though defaulting to 1, we can double the exaggeration by setting this to 2. In fact, an exaggeration of 5 works fine for the “demo.tpl” template file. The “Next Station Method” governs how “N” for next, from the stakeout graphic screen, moves you up. When set to “None”, N for Next will stay put until you change your entries. But if set to “Next Offset (Left to Right)”, Next will stay on the current station and move to the next offset. The “Next” in the dialog below, however, always increments the current station by the next station in the List. Don’t confuse the Next button on this screen, with the N button on the graphic screen to follow, which is influenced by “Settings”, and moves you along after you complete each point stakeout.
- Station:** The value of the Station to Stake.
- Interval:** The horizontal distance to increment the stationing when using the Next and Previous buttons.
- Play/Pause:** This button allows the user to play through the road file like watching a drive-through movie.
- List:** Depending on the settings and specified interval, “List” will list the defined stations including intervals and critical stations.
- List Offsets:** This dialog allows the user to pick from the known offsets by a list rather than using the graphic screen below. It also allows the user to select

an optional second point of "Reference" for reporting cut/fill information while staking. So you could stake the shoulder but also reference cut and fill to the centerline, as an option. With this option, the selected offset and the secondary reference offset will both be reported to.

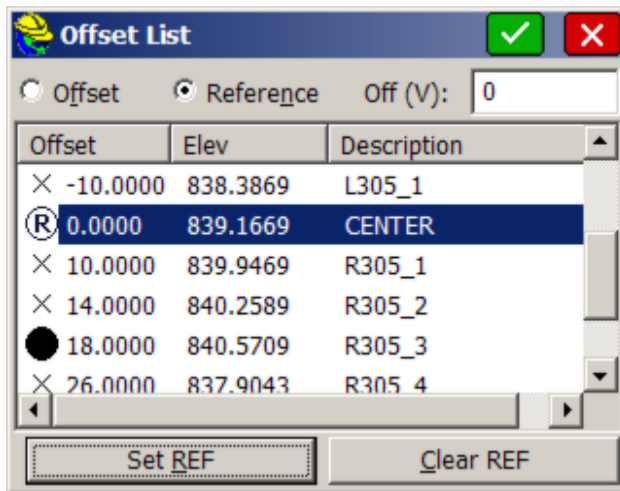

The resulting plan view in stakeout shows cut and fill to both the reference and the target point.

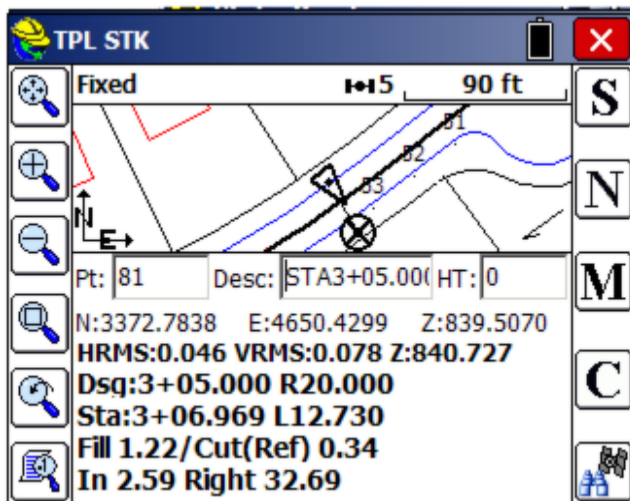

- Design Offset:** Any offset can be entered, even if it is not a "break point" on the template. For example, an offset of Left 5 (-5) or Right 7.23 could be entered. For every design offset point selected, the elevation is calculated and presented. You can select the offset point from the offset list or literally pick it on the screen. The touchscreen is active in the graphic, so you can select the -12 (EP) just by picking it. Picking on the graphic screen will take

you to the "Offset List" screen for verification, where you can confirm your pick by pressing Enter or selecting another offset.

- Stk Off(H):** Horizontal offset from the design offset. If you enter a stake offset of 2 and the design offset point was at 12, then the stake would go in at offset 14 off of CL, but the cut/fill would refer to the elevation at the design offset location of 12. The stake offset and Off. to CL inter-react. A stake offset entry of 15 with a design offset of 12 left calculates to a setback of 3. If you click the "Stake Off" button, you can choose from a variety of methods to create an offset point, including extend current slope, apply next slope, vertical offset, or user-defined slope.

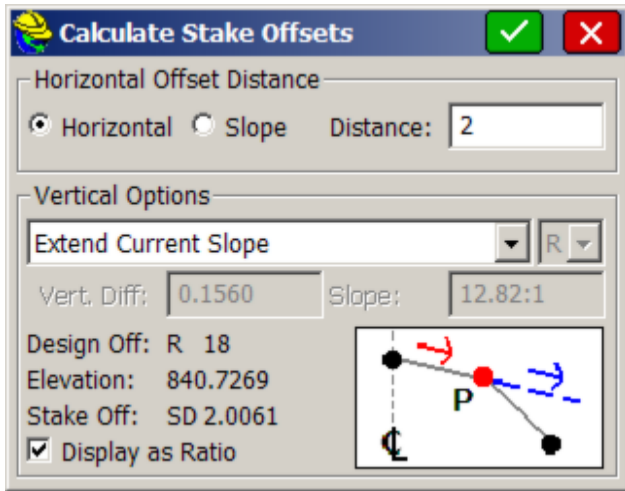

Your offset is then computed and shown graphically:

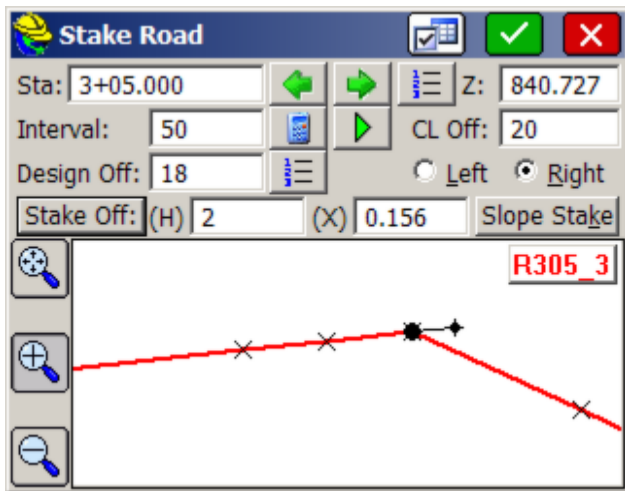

Note that you can zoom and pan in the dialog above. Pan using your finger or stylus.

- **Stake Off Button:** This button allows the user to specify the horizontal and vertical offsets relative to the design offset. Various methods can be used for computing the offsets based on the template or section points and their elevations.
- **Off to CL:** This is the total distance that the stakeout position is from the defined road centerline.
- **Vert. Off (V):** Vertical offset from the design elevation.
- **Elevation:** Elevation to be staked. This value is based on the combined design elevation and vertical offset.
- **Run Slope Stake:** This feature allows for dynamic slope staking in the middle of the Stake Road routine. This option is very useful for road staging, and also for staking interior catch points like central median ditches. When the slope stake is completed, the program returns to the main Stake Road dialog. Any point in the template or section can be used for running in a slope stake. You are asked to specify the desired cut-and-fill slope ratios. The slope can be auto-defined or user defined as follows:

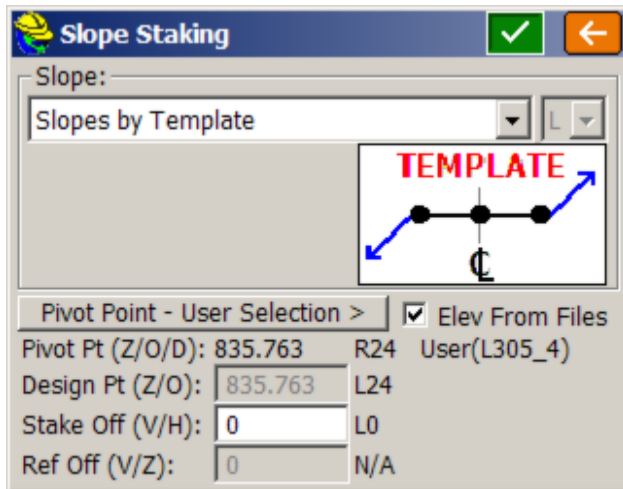

Define Slope by Next Section Point: This option allows you to select the edge of the road and use the proposed design catch point for auto-determining the slope rate.

Define Slope by Previous Section Point: This option allows you to select the proposed design catch point and then use the next point toward CL for auto-determining the slope rate.

Extend Current Slope: This option will allow you to pick the edge of the road or catch point and use the next point toward CL to end the slope between then away from CL.

User Defined Slope: Allows you to enter the slope ratio by hand for on-the-fly slope changes.

Slopes by Template: This option extracts the slope definitions from the template file itself.

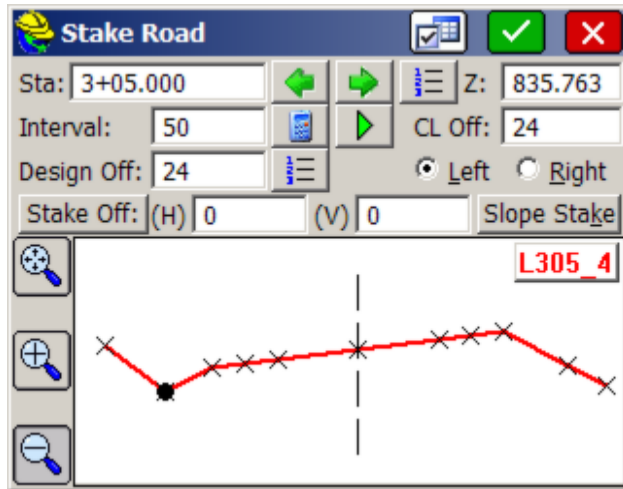

If you click Slope Stake, you can stake by the template slope for the ditch shown on the left side, or you can enter a user-defined slope to override what is in the template.

- **Pivot Point:** This option allows the user to perform on-the-fly offsets relative to the stakeout position.

Stakeout Views

Stake Road now allows you to navigate to the point in either plan view or cross section view. Select the helmet icon and choose Section to see a section view and choose Plan to return to plan view.

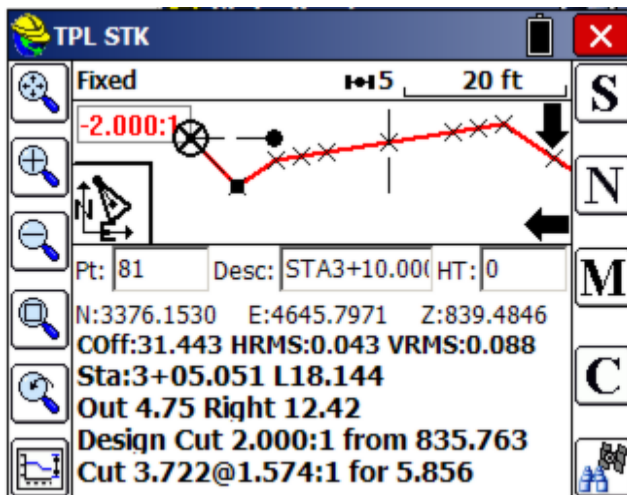

Cutsheets

Stake Road will produce Alignment-style cutsheets that include the option to report station and offset as well as the cut and fill to any point. These are fully described in Stake Line/Arc, Elevation Difference and in Job Settings, Stake Tab. If using Slope Stake within Stake Road, a slope stake report, including "progressive" and "total" distances to all template or section points, can be output. On the first screen of Stake Road, the "Store Stake" option can be selected, leading to "Story Stake" style Cutsheets (basically cut and fill reports on one side or both side of the cross section at all break points). Using the Grade Stake Method (see below), special Grade Stake cutsheets can be produced.

Grade Stake Method

Regardless of the selection used to define the road (Design Files, Sections, Cut from Map Alignments or Road Model), the Grade Stake Method can be used for stakeout by clicking the "Grade" option at the top of the road stakeout screen, shown below:

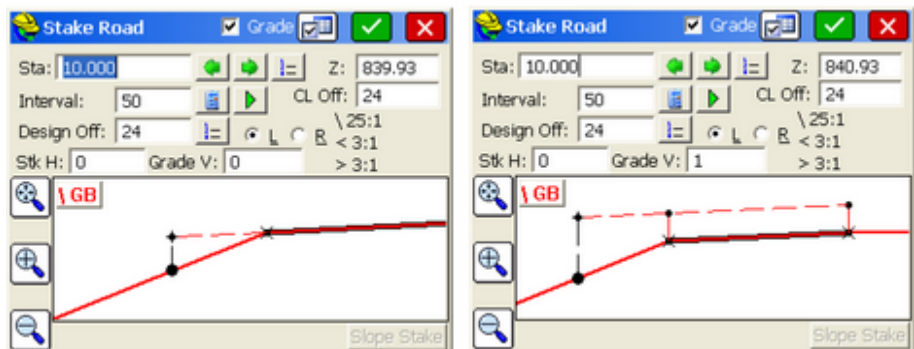
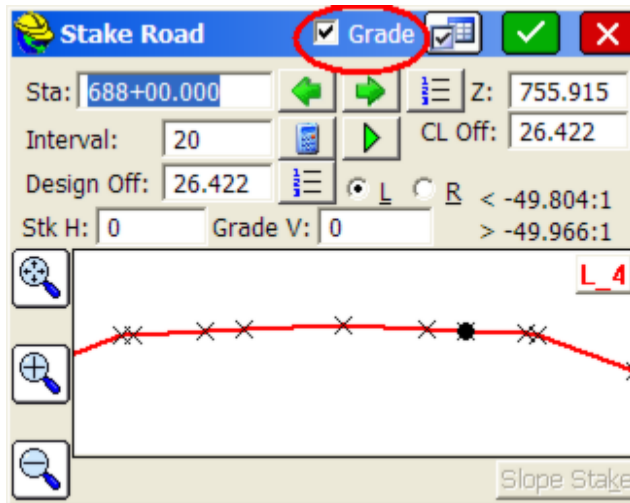

This option is popular in places like Australia and the UK. When you enter an

offset like 24 Left (shown above), you can then pick any grade on the selected side by tapping the screen, typically closer to centerline, and that grade will extend to the offset shown. The goal is to mark the grade stake with a line representing the extended slope. You can also add an offset to the vertical grade as shown at right. The process involves 3 quick steps: (1) click Grade at the top of screen, (2) select an offset, (3) pick a grade on the screen to extend and stake.

The grade stake can be placed anywhere. You can place the grade stake on the left side of the road and extend the grades on the right side of the road as shown below.

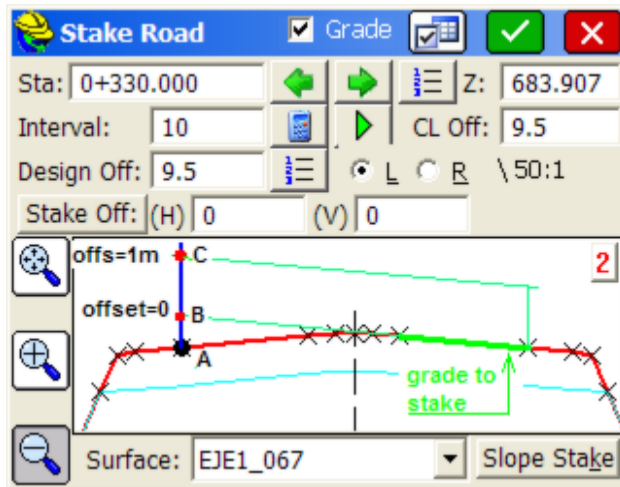

Point A is the position of the targeted grade stake, and the goal is to mark the stake by extending the slope of the selected grade (green one) where it intersects the vertical position of the stake (point B for vertical offset=0). You normally use a vertical offset when using grade stake (here shown as 1 meter) to find point C intersection. This methodology offers a handy way of checking a grade by placing the eye at the 0 offset of the grade and sighting down the grade, to verify if the slope is perfect, tangent to the line of sight.

When you click OK, you will be guided to set the Design Offset, the Grade Stake, and when on the point, you will obtain the cut or fill (typically fill value) to mark on the stake to match the extended grade (lower green line with zero offset, upper green line if a (V) or vertical offset is entered). You also have the option to position the stake anywhere on that station, since as you move in and out on the section, the program calculates the extended slope at your offset location. You could choose to place the stake at offset left 8.0 units, and you would get the cut/fill for that location. Cut and fill is computed from the bottom of the pole to the extended surface in green (either B, or C if an offset was used). If the pole is placed on top of the grade stake itself, then the cut/fill is to the top of the stake. In the graphic below, if you drove the stake at your current location, measuring up 1.01 would match the projected, extended grade, and the base of the pole is just 0.01 below the extended surface grade with no vertical offset.

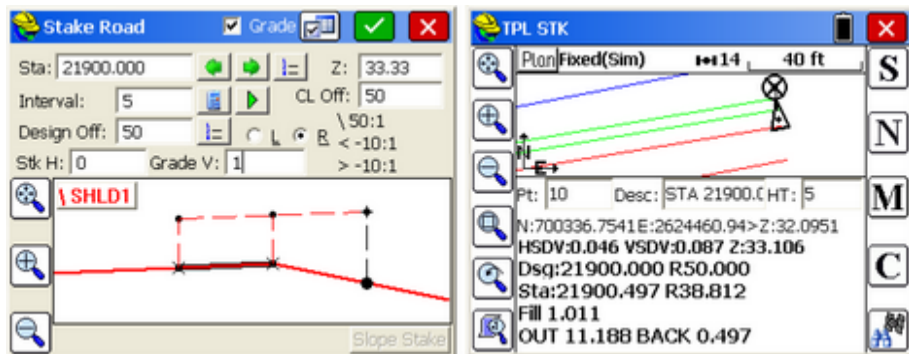

Opposite the "Design Offset" setting is a "From List" button, allowing you to pick the Design Offset to use. Click on this option and note that when using the Grade Stake Method, an extra "Grade" option appears for selecting and reviewing the offset segment in use.

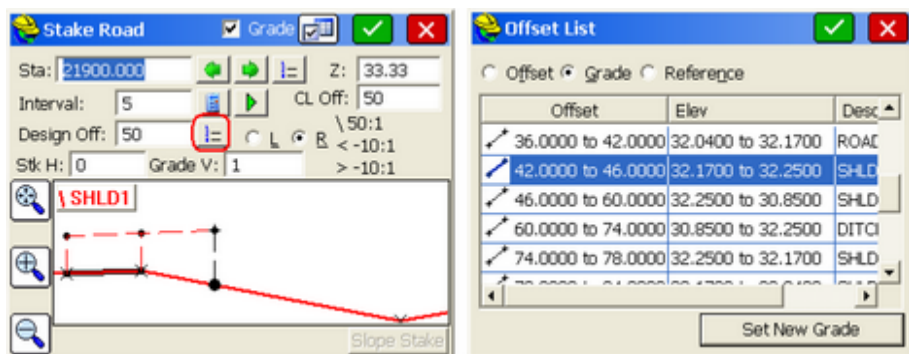

Note also that the grade segment slope is reported in the upper highlighted slope percent or ratio (as configured), and the slope at the design offset (50) or grade stake position is shown, both left and right of the selected position (in this case 10% or 10:1). Configuration of ratio vs slope can be set by clicking the Settings button at the top of the dialog, then going to the Road tab. The outer ID of the selected grade segment is presented in the upper left as "\SHLD1". The ID of the Design Offset to Stake is presented in the upper right of the graphic screen, as in "Ditch". When the selected Design Offset is not a section or template break point (eg. 50 below), no ID is presented in the upper right.

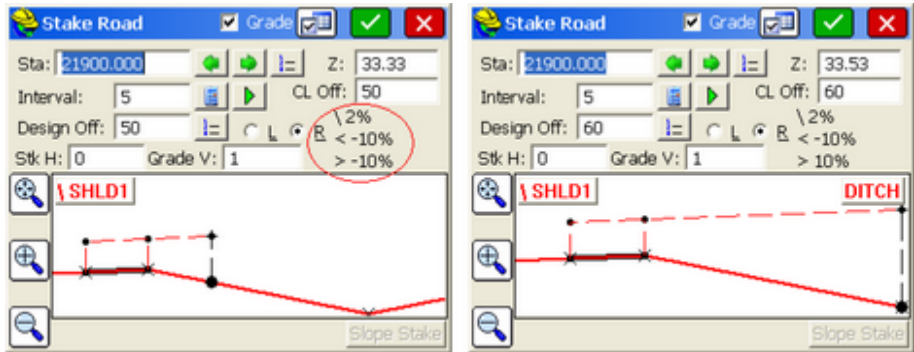

The Grade Stake method produces its own "Cutsheet" file or report of cut and fill. The Grade Stake report can be configured in Job Settings, Stake tab. Here is a report for stations 21900, 21905 and 21910, and shown in full below by using Excel to display the comma-delimited file, SC31GS.txt:

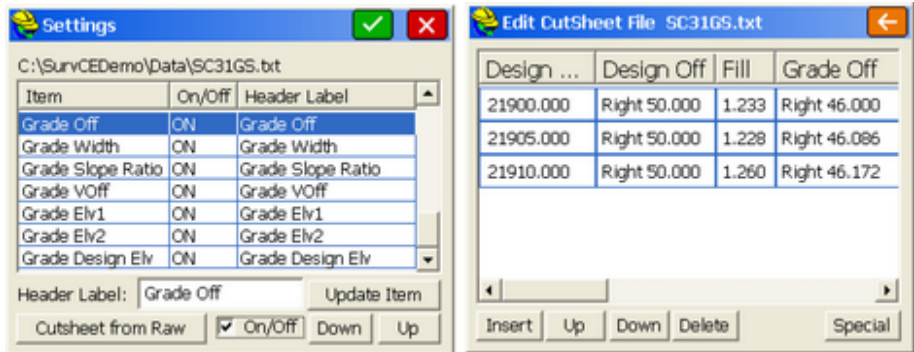

A	B	C	D	E	F	G	H	I	J	K	L	M
#Design Sta	Design Off	Design Elev	Stake Elev	Cut	Fill	Grade Off	Grade Width	Grade Slope Ratio	Grade VOff	Grade Elv1	Grade Elv2	Grade Design Elv
21900	Right 50.00	33.33	32.098	1.233	Right 46.000	4.50	0.00	1	32.25	32.17	33.331	
21905	Right 50.00	33.334	32.106	1.228	Right 46.086	4.51	282.1	1	32.258	32.181	33.334	
21910	Right 50.00	33.339	32.079	1.26	Right 46.172	4.53	333.1	1	32.267	32.192	33.339	

It is worth noting that Slope Staking from the command Stake Road is disabled when in Grade Stake mode, since the two features are not related. Simply turn off Grade Stake method to re-activate the Slope Stake button.

Grade Stakes can even have a Horizontal Offset as shown below. On this right side of road Grade Stake example, a -3 horizontal offset tilts the stake point in towards centerline, to the left. The resulting stationing to stake is 21915. This is essentially the same as entering 21915 directly.

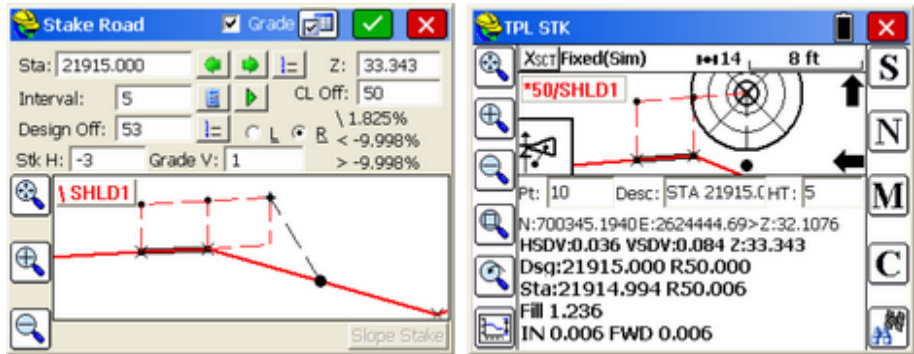

The circle with the X inside is the final target point, illustrating the effect of both a horizontal and vertical offset. That is where you would place the stake and mark the projected cut fill point on the stake, or record it as text. Again, you don't need to set the stake at the target point--you know the cut and fill of the projected slope wherever you are, as long as you stay on the correct station. As you move left or right on the correct station, the design elevation is calculated at that offset (it appears to the right of the HRMS value above, as 33.343). Your actual pole reading is the Z:32.1076. So the fill here is 1.236, represented by the vertical black line from the solid circle (your current position) to the projected slope (shown in red). You can drive a stake there and mark a line 1.236 above the ground, to represent the projected slope at 1 vertical offset. But if you were at offset 45, the design elevation would be calculated at offset 45 and the fill would still be valid. If Fill is reported, you would drive the stake and measure up from the ground the fill distance, to mark the stake. Fill is from the desired red projected grade to your ground position. If Cut is reported, then you are above the projected slope, and you would need to simply note the cut on the stake, since the projected slope cannot be marked on the stake.

When Grade Stake is turned on, be aware that when returning to the Stake Road command, the "Grade" option will be default on. Turn it off to use Stake Road in the conventional way.

Story Stake Cutsheet Example

The Story Stake Cutsheet Report, is a report of cut and fill (see Job Settings, Stake tab, Cutsheets option). The term "Story Stake" means that the entire "story" of the cut and fill, across the entire cross section (or up to centerline only if so configured) can be reported based on a single offset point staked on the road. The story stake report shown below will be created using cutsheet configuration tools.

Design Sta	Hub Offset	Hub Elev	Cut
1+000.000	Right 4.986	28.404	
TIE	29.014		5.504
DL	23.014		8.404
SH	15.014		2.604
EP	7.014		2.104
CL	4.986		1.904

Buttons: Insert, Up, Down, Delete, Special

In this report format, each station takes up a row including the actual point staked, which in this case is renamed "Hub Offset" and "Hub Elev". Then below this row, each offset description appears, including the offset distance and cut/fill from the field-staked point (note the centerline is the same distance as the Hub Offset). This simple and useful format is configured as follows:

Referring to the opening screen of Stake Road, turn on "Show Story Stake Report". Prior to entering the Stake Road command, within Job Settings, Stake tab, Cutsheet option, under the Story Stake option, choose Select File, enter a new file name (for the story stake "txt" file) and then update as shown below. Use the "Up" button to move up the fields needed for the report. The "Desc" field is optional, and the report shown above omits it. Note how the default "Staked Elev" is changed to "Hub Elev" using the "Update Item" option at the bottom of the dialog. Click "On/Off" to turn off all selected items below the "Fill" option. Target only 6 "On" items, or 5 if "Desc" is omitted.

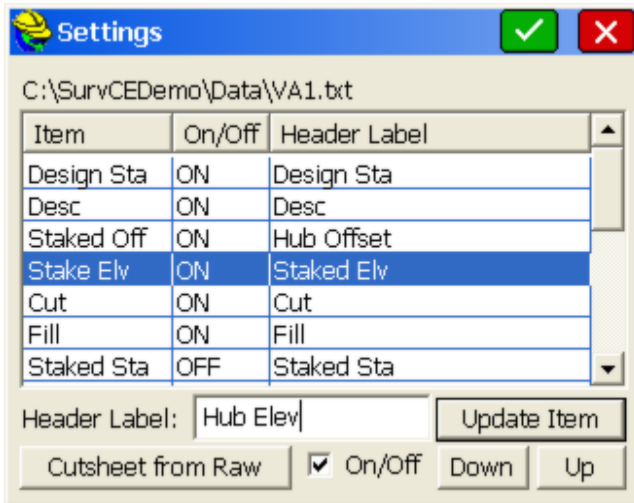

The "Hub Offset" on the first line appears as "Right 4.986". This "Right" or "Left" (vs R or L) is configured by clicking Settings in the "Cutsheet" opening dialog within Job Settings, Stake tab. The "Store Grade ID Only" works very well within Stake Road, Cut from Alignments, since the Grade ID is captured from the layer name of the selected entities. Grade IDs can also be entered using Road, Utilities, Input-Edit Section File. These Grade IDs are then displayed beneath the Design Station, in the first column, based on this setting. Configure as shown below to obtain the above report:

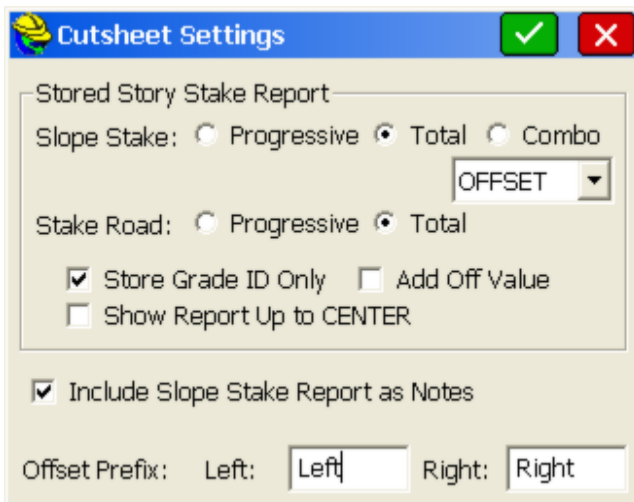

Slope Stake Cutsheet Example

Slope Stake is an option within Stake Road. Using the same "Cutsheet Settings" shown above (in Job Settings, Stake Tab, Cutsheets option), as it applies to "Slope Stake", the "Store Grade ID Only" option, clicked on, leads to the slope stake report shown below. Note the key first 3 elements which need to be

configured when creating the Slope Stake cutsheet file (Design Sta, Desc, Pivot Off). Just like with the Story Stake, the "Store Grade ID Only" places the section ID underneath the first column "Design Station" but goes further and places the Horizontal offset from the staked point under "Desc" and the vertical offset under "Pivot Offset", leading to a very simple and useful report. In this example, the catch point is a "top of slope" point above the ditch, which explains the positive vertical offsets to the ditch and even to the shoulder point.

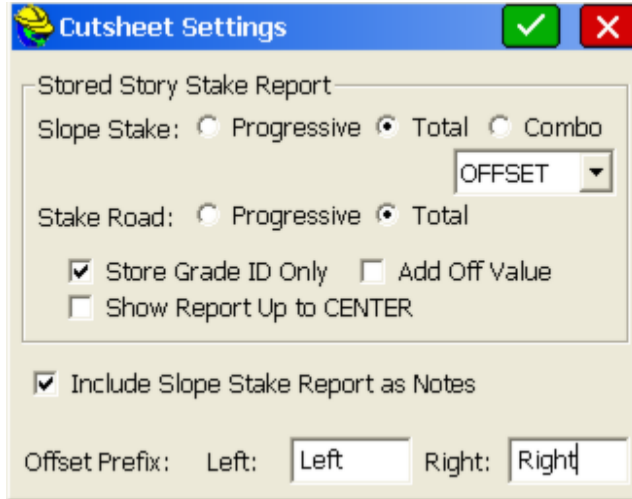

MAP

This chapter describes the use of the MAP screen. The MAP screen commands are available in the pull down menus or at the command prompt. The MAP screen is useful for drawing, COGO, creating points for stakeout, and for the import and export of DXF and shape files. No measurements are taken from the MAP screen.

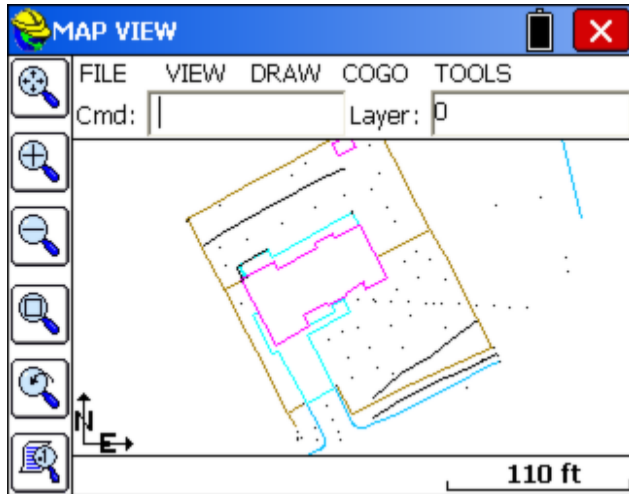







Basics

The **MAP** screen is accessed by tapping the globe icon in the upper right of the main menu. The basic operations of the MAP screen are described here.

Map View Icons

The commands associated with the MAP View Icons are described in the figure below:

	Zoom extents: Zooms to the extents of the map, showing all points and objects.
	Zoom in: Zooms in 25%.
	Zoom out: Zooms out 25%
	Zoom window: Zooms into a rectangular area that you pick on the map screen.
	Zoom previous: Zooms to the previous view, SurvCE remembers up to 50 views.
	Opens the View Point Options dialog

The View Options button in the lower left opens up a 3-tab dialog with many additional settings for viewing points. For example, you can display just the Point ID, or you can turn on elevation and description display. With the elevation display on, you can even make the decimal place on the elevations be set as the point location, to save screen space.

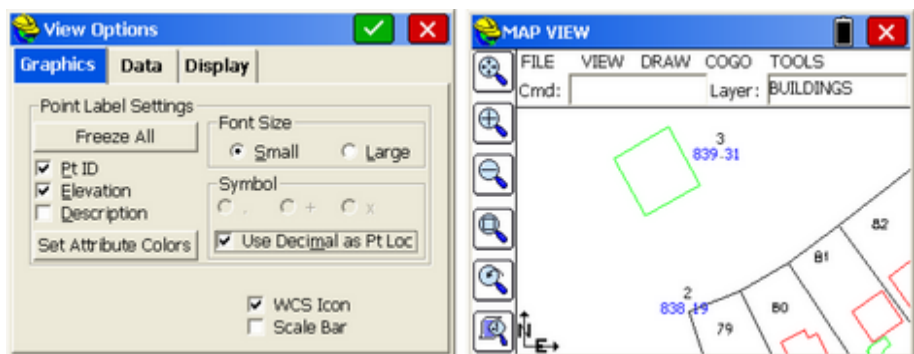

By default, points are black, elevations blue and descriptions green, but these color assignments can be changed with the option "Set Attribute Colors". Point fonts can be made large and you can also show a Scale Bar in addition to the WCS Icon. If description is clicked on but there is no description, none will be displayed.

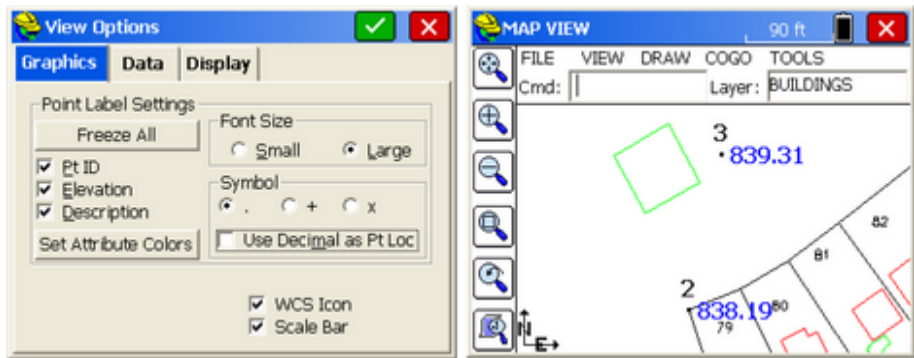

Clicking the Data tab brings up "Intelligent Zoom" and Traverse Defaults. Intelligent Zoom, if turned on, makes selection of points easier. If you are inversing between points or selecting points by clicking them on the screen, Intelligent Zoom detects distinct clusters of points and zooms to those clusters for easier selection, rather than bringing up a long list of points to choose from after clicking. Since this only applies to point selection, keeping Intelligent Zoom on is generally a good idea. Regarding Traverse Defaults, this option enables zenith angle prompting as you traverse or sideshot in the Map screen. It also sets whether hand-entered, Map screen traverse and sideshow entries are stored to the raw file.

The Display tab allows the map to be turned in any cardinal direction, such as South instead of North (below left). In addition, maps can be mirrored (below right). These views apply also to the active survey and stakeout screens.

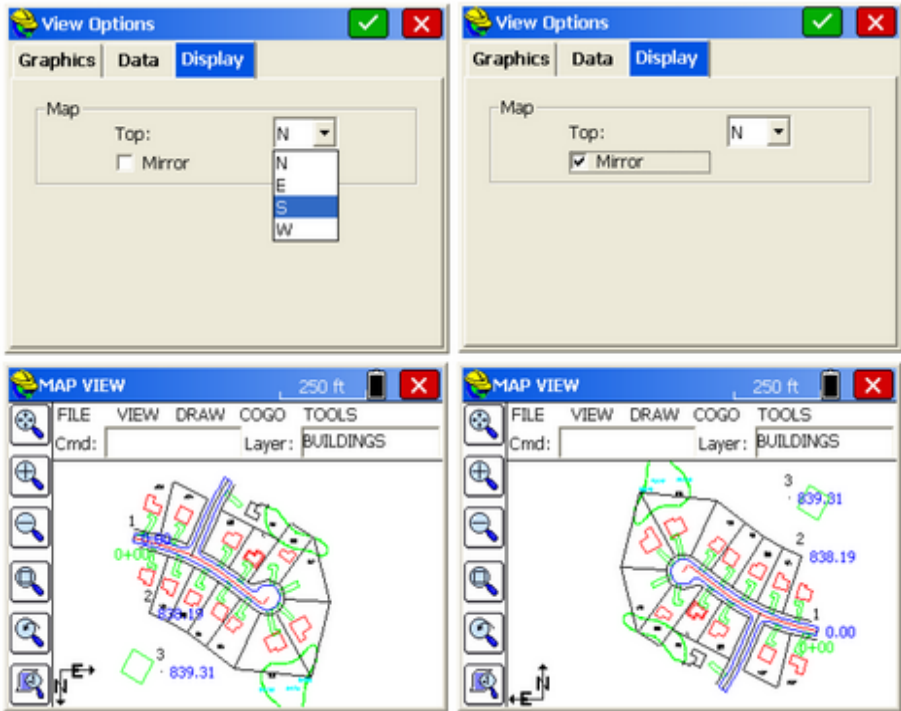

Executing commands in Carlson MAP

The MAP screen defaults to a pull down menu format containing over 90 additional commands, virtually doubling the number of commands found in the Menu Screens. Many of the commands in MAP offer CAD-like features such as layer freeze and thaw, predetermined area, polyline offsets and even contouring. One of the most important commands is Polyline to Points, which allows you to create points for reference or for stakeout (set out) from any selected polyline. The MAP screen also includes a command line format that can be set using Preferences. Several MAP screen pull down menu commands involve “fly out” options, as shown below.

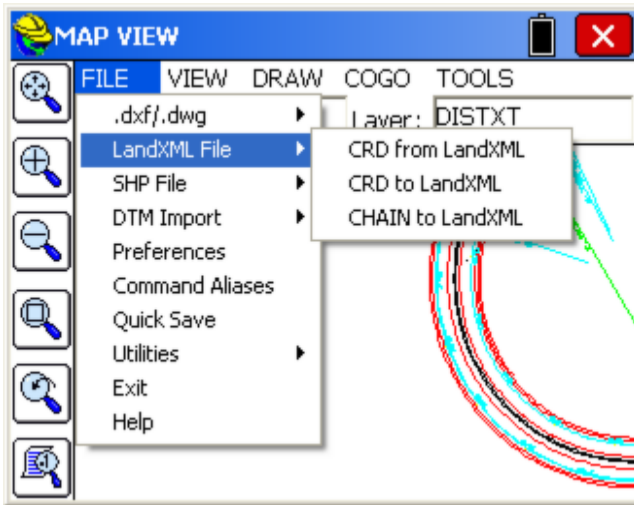

Alternatively, you can enter the command name, or command alias, at the command prompt and press **ENTER**. In many cases, the user can start a command while using another command. The newly started command is called a "transparent" command. Each command from the left-toolbar menu is a "transparent" command.

Usually, a command does not immediately execute. Carlson MAP either displays a dialog box or displays prompts at the command line requesting more information from the user. Typically, the user can select objects on the screen or enter data on the command line. Many commands consist of a series of options, structured as follows:

Cmd:Command name-Option1/option2/option3/.../(<default option>

To select one of the options, the user can enter the entire option name or only the capitalized letters, and then press **ENTER**. If available, the default option always appears in angle brackets (<>). To select the default option, just press **ENTER**. If no command is active, the user can repeat the previous command by pressing **ENTER**.

Panning the Screen

The user can move the drawing display (**PAN**) anytime. To use this command, the user must hold down and slide a finger — or the proper pointing device — on the screen. The drawing display is moved in the same direction as the pointing device. When you release the pointing device, the panning stops. Only the display moves and all objects retain their correct coordinates. Be careful to start the pan by picking in "empty" space. If you hold down on a point, you may obtain the "Point Details" screen, or you may see a list of points to select from (to see Point Details). If you hold down on a line, you may see the "Line Details" screen.

Point Details

Unless you are in the middle of a MAP screen command, you can click on a point and see a Point Details dialog. If you tap near several points, a list of nearby points will appear from which you can select the target point. Otherwise, you will go straight to Point Details, and see a screen that includes the option to delete or edit the point.

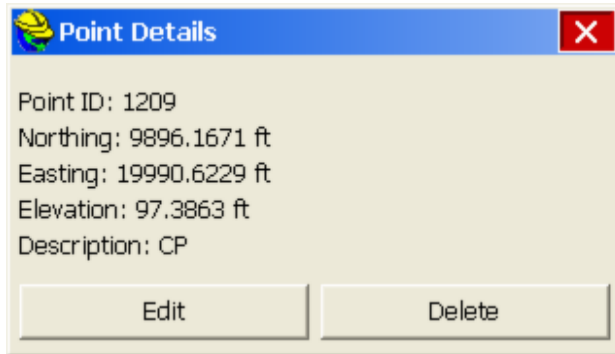

If you are in total station mode, and actively surveying (with a setup and backsight specified), clicking on the setup or backsight point will lead to a special graphic, as shown here:

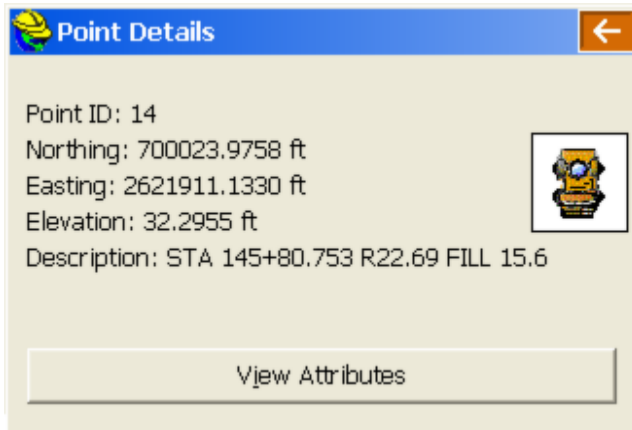

If you have assigned attributes to the points (e.g. Description Pole, Type-Metal, Wires-4, etc.) by use of the Feature Code capabilities, these attributes can be reviewed. The Point Details option works both within the MAP screen (when you are not being prompted for entering points or selecting objects) and in all graphic screens within the Menu options. It is not as transparent and available as the dynamic pan option, but nearly so.

Line Details

Unless you are in the middle of a Map screen command, you can also click on a line and see Line Details. Clicking the line at the lower edge of the drawing (a blue ditch line) leads to a simple Line Details display:

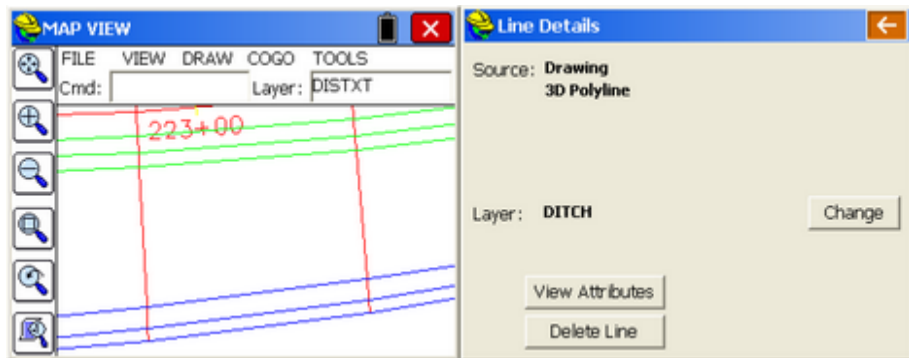

You have the option to delete the line or change its layer or View Attributes (if any). If the polyline (a line with 2 or more vertices) has different elevations on some of the vertices, then it is designated a "3D Polyline". A more advanced Line Details is provided when using Feature Codes within the Store Points command, allowing extension of lines and new lines from vertices on the polyline. The advanced Line Details is discussed under File, Feature Code List.

FILE

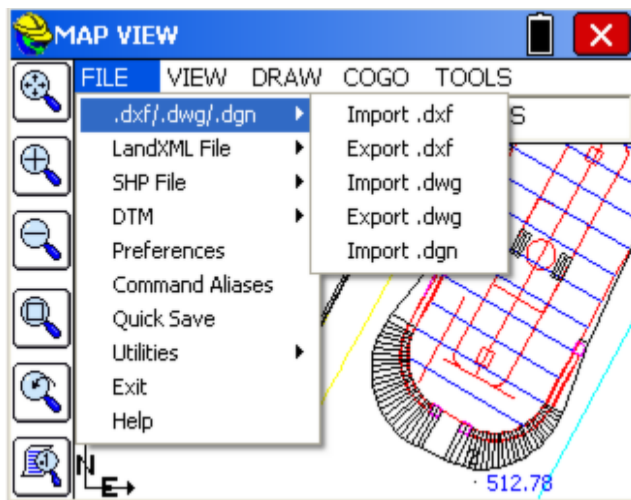

DXF File - Import DXF (IDXF)

Similar to the AutoCAD(r) DXFIN command, will bring in polylines from AutoCAD, Microstation, Terramodel and other products that can export data into a DXF file format. Text can be imported. Blocks under 256k are imported and can be selected or "snapped to" using the node or center snap (if a circle). For block or text importing to work, turn on "Allow Import .dxf/.dwg/Esri Options" within Job Settings, Options, in the File Menu. See discussion in **Import DWG**.

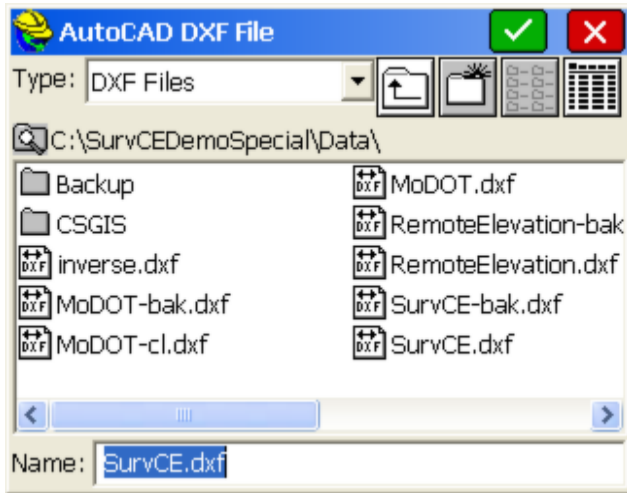

DXF File - Export DXF (EDXF):

The **EDXF** command is useful for exporting files to Microstation, Autocad, Intellicad, ESRI and virtually all other CAD drafting programs. It provides controls for displaying points and also for displaying GIS attributes associated with points and linework.

The **EDXF** command, similar to the AutoCAD(r) DXFOUT command, will export a DXF file. It captures not only 2D and 3D polylines and their layer names but also exports all visible (layer on) points from the CRD file into AutoCAD “Point” entities form (layer PNTS). All points and polylines that are visible (layers on) would be exported, not based on the current screen zoom, but based on the full extent of the drawing.

The **EDXF** command has many special features for displaying the points in the exported drawing. Consider the source drawing below:

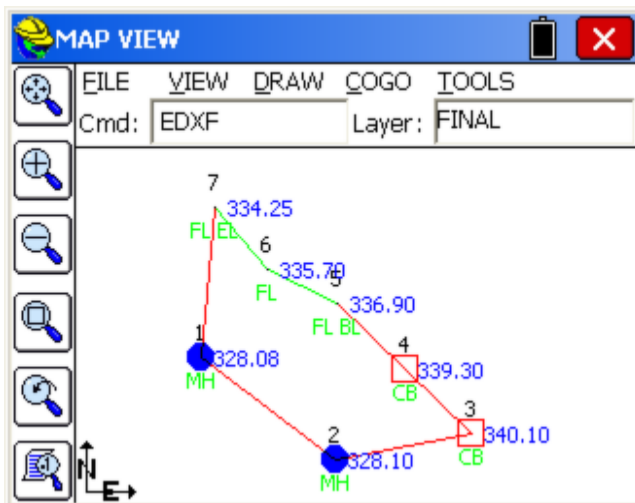

When the Export DXF command is issued and a file name is entered, a dialog appears with options shown below. If you choose "Create block attribute on layer: 0", then all attributes such as point number, elevation and description take on the layer of the node. In this case, all point attributes inherit the fence line layer for the fence points and the utility layer for the catch basin and manhole points. If you do not put the attributes on layer 0, then they have distinct colors and layers for the number, elevation and description. In addition, if you click on "Save GIS Point Feature to Block", then if GIS attribute data is included, this data will appear beneath the description in a vertical, left-justified column (eg. 5.4=depth, 2=number of inlets, Cast Concrete=type).

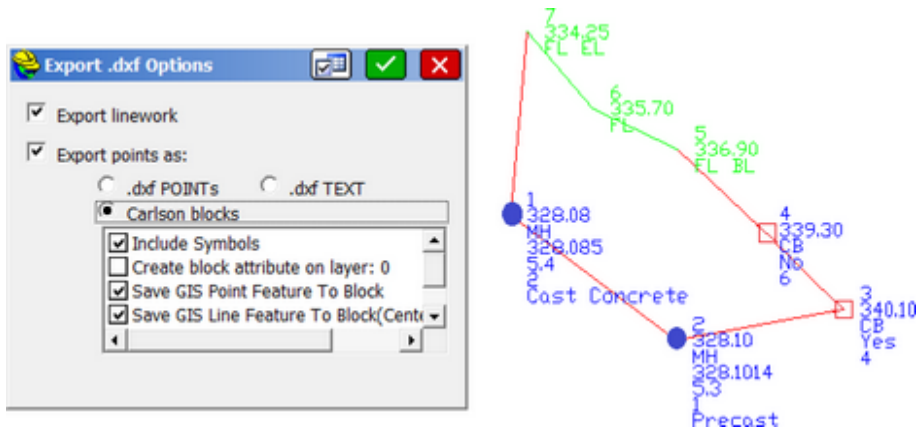

If the points are exported as Carlson blocks, then they will move as one object within CAD, when selected. Another option is to export the points as ".dxf text" in which case each distinct piece of text can be selected, moved and edited.

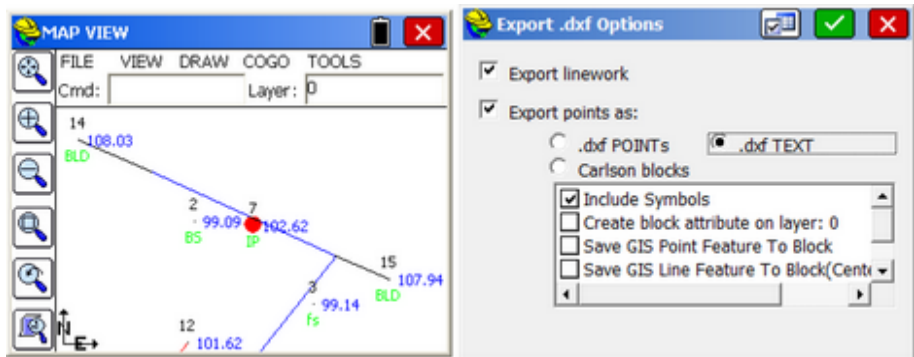

Click the settings button at the top of the screen to change the text height and row spacing for the text. In the example below, we've moved the description of point 15 above point 15, since it can be selected and moved individually. Note that solid, circular point symbols import as basic circles. All points are imported with a node to snap to within CAD, even in "AutoCAD text" mode.

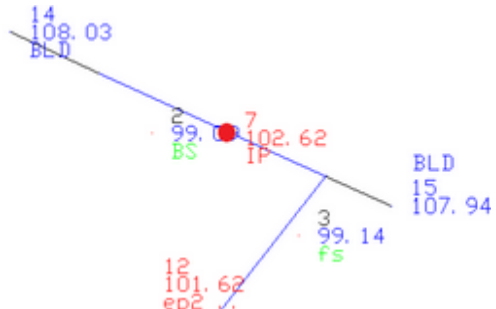
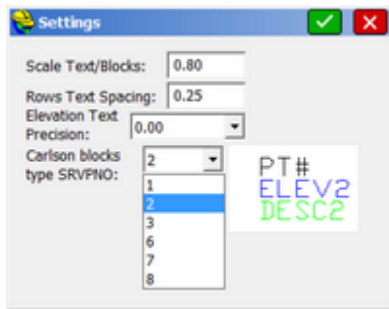

Other options in the command include drawing GIS line feature attributes and Saving Point Labels on separate layers. If "Save GIS Line Feature to Block (Center)" is clicked on, then attributes associated with a polyline will draw in the middle of the longest segment of the polyline. If "Save GIS Line Feature to Block" is clicked on, but the "Center" option is not clicked on, then the GIS attributes of the polyline draw on the second point of the line, below the other "standard" point attributes such as elevation and description. Shown below is the combination of normal point attributes (not placed on layer 0) and linework GIS feature plotting, shown associated with the second point in the polyline.

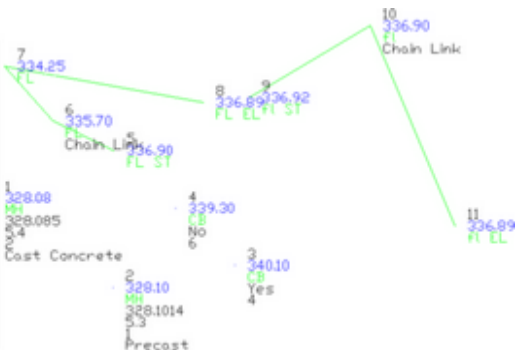
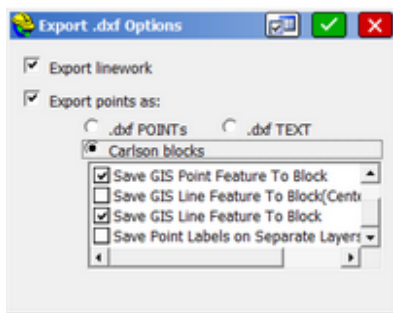

The "Save Point Labels on Separate Layers" option places the exported points on the layers associated with the point descriptions, as defined in the Feature Code List. If "EP" points are defined as going on the "Road" layer, then when exported to CAD as a DXF file, these EP points will be on the Road layer, and BLD points associated with the "Building" layer will be on the "Building" layer in CAD. In this way, the exported points can be turned off an on by use of layer commands.

DWG File - Import .dwg (IDWG)

The IDWG command directly loads a ".dwg" file into SurVCE and all layer names are retained. Text is imported but hatching is not imported. Only blocks under 256K, polylines and text will appear in SurVCE. Blocks such as symbols can be "snapped" to for stakeout using the node/center snap, which also serves as an insertion point snap. Text can be "snapped to" also using the node snap, in which case the text insertion point will be used. Be sure to go to File in the main menu, Job Settings, Options and turn on "Allow Import .dxf/.dwg/Esri Options". When these options are turned on, you obtain the following prompting when Importing:

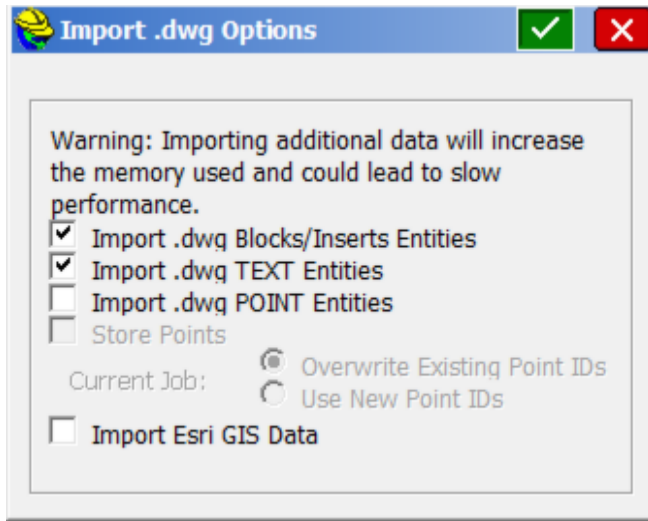

Note that Point Entities, points plotted in Autocad or in Carlson Survey and other Carlson products, can be imported and also stored as points within SurvCE.

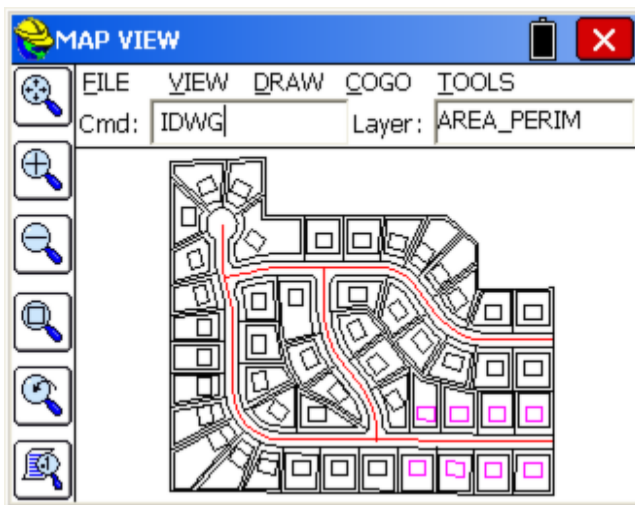

Importing Blocks and Importing Text in the DWG file

Blocks that are used in Autocad or Intellicad or other CAD packages using ".dwg" formats like Graebert and Bricsys can be imported into Carlson SurvCE. For block importing to work, set Process Block/Insert on within File, Preferences. In the example below, the storm sewer inlets are shown as a "grate" symbol, in various rotations. Note that these symbols import into SurvCE 3.0 and higher directly, including with rotation.

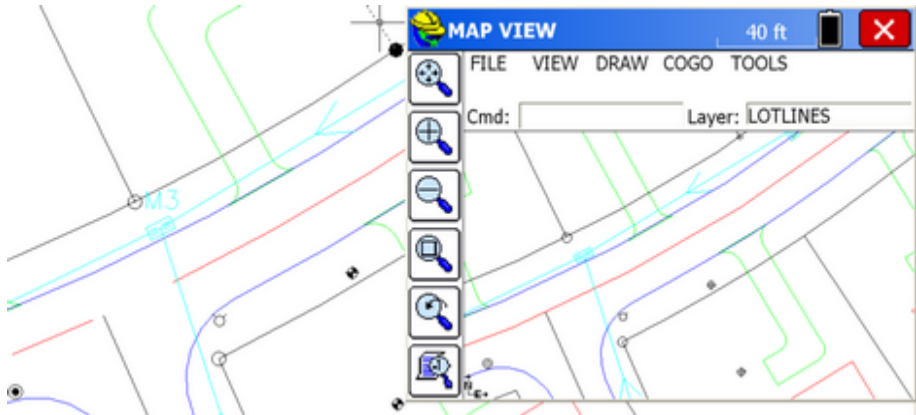

Note above that blocks with solid fill are imported as only the outline. Note also that the inlet grate near M3 in the .dwg file in CAD, at left, is imported with correct rotation. (Text was not imported in this example). All imported blocks can be staked out using the "cen" or "center" snap, which doubles as an "insertion point" snap. All forms of Text can be imported optionally with the exception of MText. Text created by the "Text" or "DText" commands import as shown below, using a single "Carlson" font style at present:

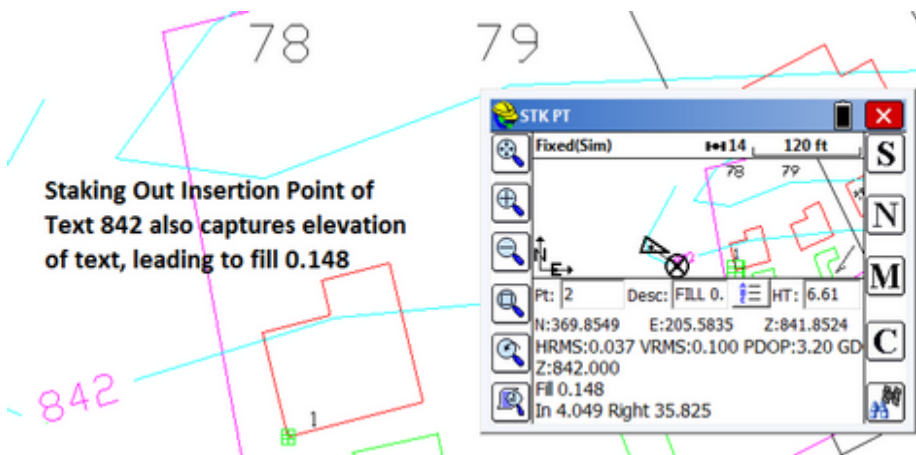

Note: If a .dwg file is exported from ArcMap 9.1, 10.0 and 10.1 using the command "Export to CAD", then this form of a .dwg will import in SurvCE with all associated ESRI attribute data captured. This data can then be edited, and new features and attributes can be added to the map. Then the EDWG (Export DWG) command in SurvCE will return the full drawing with associated attributes back to Esri ArcMap 9.1, 10.0 and 10.1, when imported.

DWG File - Export .dwg (EDWG)

The EDWG will export to ".dwg" format all linework appearing in the SurvCE Map screen, regardless of origin (imported, drawn in the MAP screen, created by Field Codes). Layers and even line thickness (as created by field codes) will be

retained in the exported drawing. The controls for exporting DWG files are similar to those of exporting DXF files described above, with two added options: (1) to designate the DWG format as shown below, and (2) to export MSC (metadata) in the .dwg file for import by Esri ArcMap version 9.1, 10.0 and 10.1.

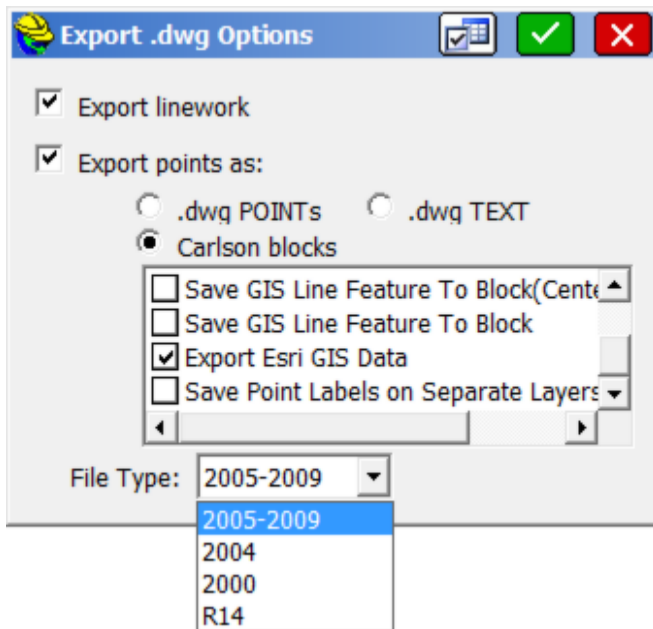

The command Import from CAD within Esri ArcMap (9.1 to 10.1) will efficiently import all screen entities and GIS attributes and store them in Esri format. Maps and data can complete the full cycle by being exported from Esri using the command "Export to Cad", editing and added to within SurvCE, then exported back to Esri for importing.

DGN File - Import .dgn (IDGN):

Directly imports a Microstation .dgn file and stores the file in DXF format, the normal format of SurvCE.

LandXML - CRD from Land XML (XML2CRD):

This command allows you to import points from LandXML format to SurvCE.

LandXML - CRD to Land XML (CRD2XML):

This command allows you to export points from SurvCE to LandXML format.

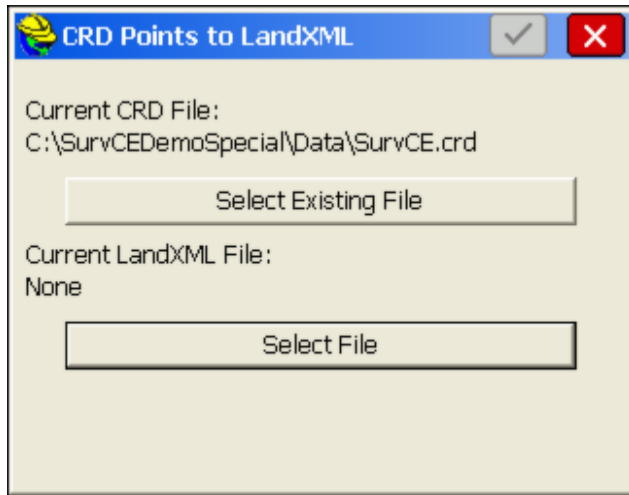

LandXML - Export Chain File to LandXML (CHAINXML):

This command allows you to export all the polylines from the current drawing created using Feature Codes, as LandXML chain objects into a LandXML file. For example, if you made strictly 3D polylines for break lines using descriptions such as EP for edge-of-pavement or DL for ditch line, then the 3D polylines can be exported as a LandXML chain file and used as break lines for contouring in other CAD programs. The combination of points and break lines can lead to optimal contouring. Most CAD packages will import linework using the DXF file approach, but many now recognize linework in LandXML “Chain” file format.

SHP File - Import Shape File (ISHP) (e.g. from ESRI):

This command allows you to import entities and also the associated attributes values from a SHP file. The routine displays "Import from SHP" dialog box. If the SHP file has POINT or POINTZ type, the entities will be stored into a CRD file. In the cases of an ARC, ARCZ, POLYGON or POLYGONZ SHP type, the entities will be stored into the current drawing. The attribute values will be stored into a *.vtt file. The routine requires a feature code name from the user, which will be used to store the name and the type of the attributes from the SHP file.

SHP File - Quick Import SHP (QISHP):

This command allows you to import entities from SHP files (used by most programs produced by Esri). The routine displays the Import from SHP dialog shown below. POINT or POINTZ type entities will be stored in a CRD file. ARC, ARCZ, POLYGON, or POLYGONZ entities will be stored in the current drawing as POLYLINES.

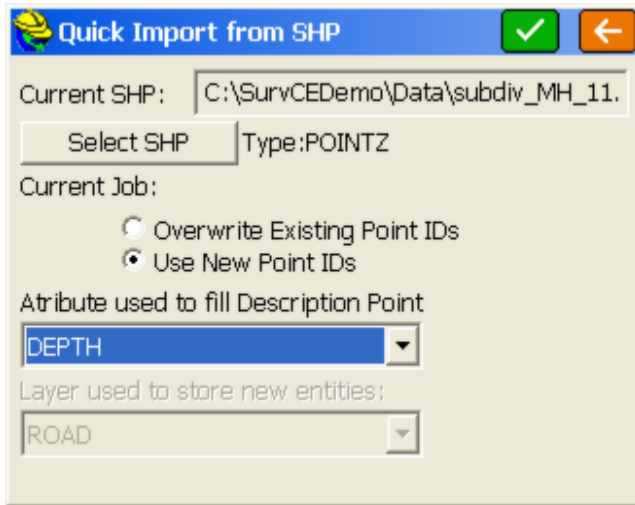

Current SHP: Displays the name of the SHP file that will be imported when this command is completed. Read-only, you must use the Select SHP button to specify the file name.

Select SHP: Tap this button to select a SHP file name.

Current Job: Available when importing coordinate data. Specify whether to Overwrite Existing Point Numbers or Use New Point Numbers.

Attribute used to fill Description: Available when importing coordinate data. Lists the attributes in the currently selected SHP file. Select which attribute to use to fill out the Description field in the CRD file.

Layer used to store new entities: Available when importing geometry. Select the layer to store the new entities.

Process: Tap the green checkmark to begin the import process. When complete, it will display, "Process done". Then click the orange back arrow to exit. If you are importing a large file, a progress bar at the bottom of the dialog will indicate the progress of the import.

SHP File - Export SHP File (ESHP):

This command allows you to export entities from the current drawing and also the associated attributes values, into a SHP file (or more accurately, multiple shape files). The routine will allow the user to select which entities will be exported, based on entity type and also based on the feature code name. The routine displays "Export to SHP" dialog box.

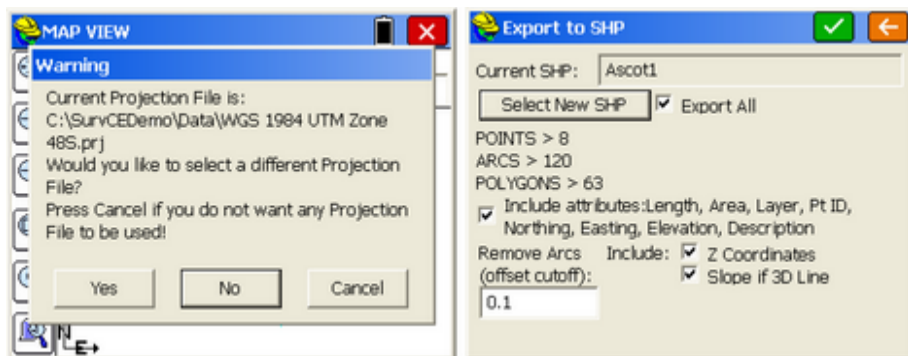

Click on Export All and include special attributes and optionally the Z coordinates. If you have point, arcs (non-closed polylines in Esri terminology) and polygons (closed polylines), all with one attribute, you will obtain up to nine files as shown below:

```
Ascot1_11.dbf
Ascot1_11.shp
Ascot1_11.shx
Ascot1_13.dbf
Ascot1_13.shp
Ascot1_13.shx
Ascot1_15.dbf
Ascot1_15.shp
Ascot1_15.shx
```

The selection of the Z coordinate places the 1 after the underline character. Otherwise, the file form would be, for example, Ascot1_1.shx (special attributes only). The “1” group represent points, the “3” group represent arcs (unclosed polylines) and the “5” group represent polygons (closed polylines). Within Export Shape file, the field name in the dbf file is expanded to handle up to 254 characters.

SHP File - Quick Export SHP (QESHP):

This command allows you to export polylines and/or points to an SHP file. When first entering the command, you may be prompted for a "projection file", a .prj file, that allows the export to overlay on grid coordinates. The ".prj" file itself is made within Esri products. You can choose to use the current ".prj" file, use another, or cancel any use of a projection file, as shown below:

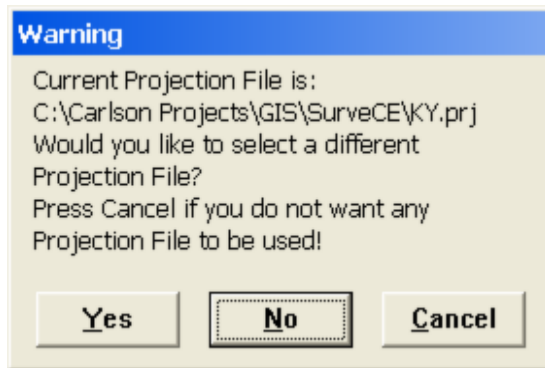

Then proceed to a dialog that displays the following options:

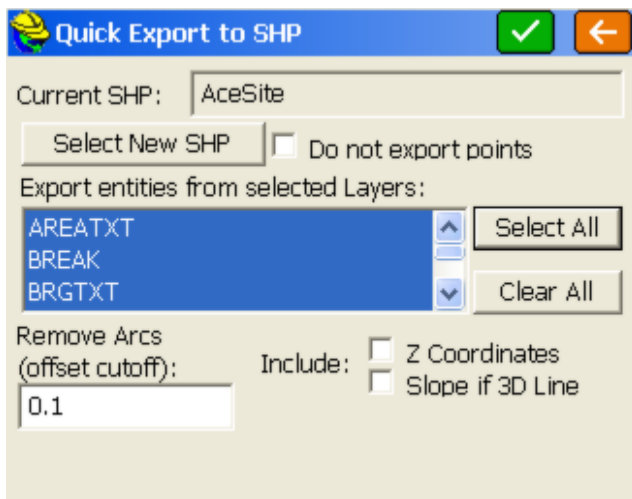

Current SHP: Displays the name of the SHP file that will be created when this command is completed. Read-only, you must use the Select new SHP button to specify the file name.

Select new SHP: Tap this button to select a SHP file name.

Do not export points: When this option is checked, only polylines are exported to the SHP file.

Export entities from selected Layers: Lists the layers in the current map. You may select certain layers for export.

Select All: Selects all layers in the list.

Clear All: Clears all selected layers in the list.

Remove Arcs (offset cutoff): Specifies the maximum distance that a vertex on a polyline segment will deviate from the original arc.

Include Z Coordinates: When this option is checked, elevation data (or Z coordinates) will be included in the SHP file.

Slope if 3D Line: If distinct, different vertice elevations are detected, you have the option to retain the starting elevation for all vertices or export the vertices with their distinct elevations.

Process: Tap the green checkmark to begin the export process. When complete, it displays, "Process Done". Then tap the orange back arrow to exit. If you are exporting a large file, a progress bar at the bottom of the dialog will indicate the progress of the export.

Export ASCII w/GIS:

Allows exporting of points with attribute data in the form Pt ID, Northing, Easting, Elevation, Description, Attribute1, Attribute2, etc.

DTM Import - DTM from DXF (TDXF):

Allows you to import 3DFACE entities from a DXF File and save them as a triangulation (TIN) file and also draw them as 3D faces.

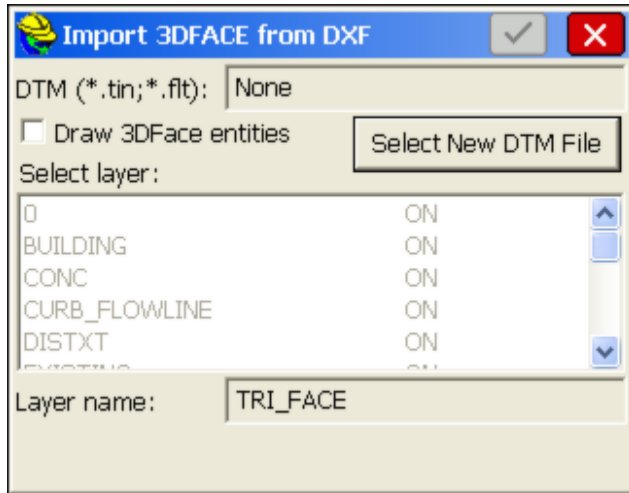

DTM Import - DTM from Land XML (TXML):

Allows you to import 3DFACE entities from an XML File and save them as a triangulation (TIN) file and also draw them as 3D faces.

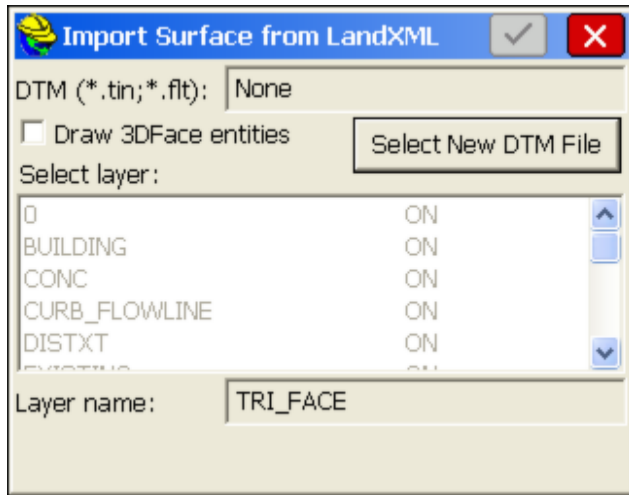

The DTM file is stored in SurvCE as a TIN file and can be used for commands such as Elevation Difference (obtaining cut/fill by comparing field measurements to the DTM).

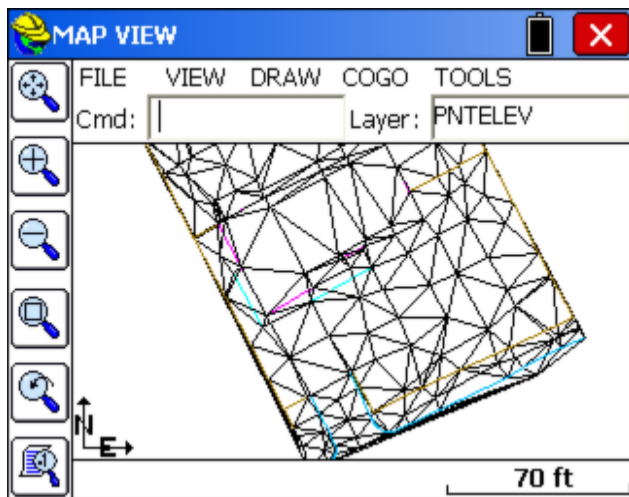

The 3DFaces are placed on a layer (TRI_FACE by default), and that layer can be turned off and removed from view. If you choose E for Erase, you can pick the 3D Face entities and erase them on command. There is no particular value to seeing the 3D Faces, so it is not recommended that they be drawn. The main value is to capture the TIN (triangulation) file for use in Elevation Difference.

DTM Export - DTM to LandXML:

Load a .TIN or .FLT file and export to LandXML format. The process typically takes place in less than 1 second. Click the back arrow to return to the Map screen.

DTM Import - DTM from Ispol:

Allows you to import a TIN file from the Ispol format, commonly used in Spain.

Preferences (SETT):

This allows the user to turn on/off the pull-down MAP menus. Menu Off is rarely used, provides more graphic space, but forces users to enter commands at the command line by typing them in (such as E for Erase). The graphic screen style of normal or reverse (solid dark) background is set here. Preferences also includes the setting "Sketch Option" which removes the "tangent" snap from the available snaps for selecting points on lines and objects and substitutes a "?" snap for sketched or randomly picked points on the screen, adding a new command "2D Sketch" under the Map Screen, Draw, Polyline options.

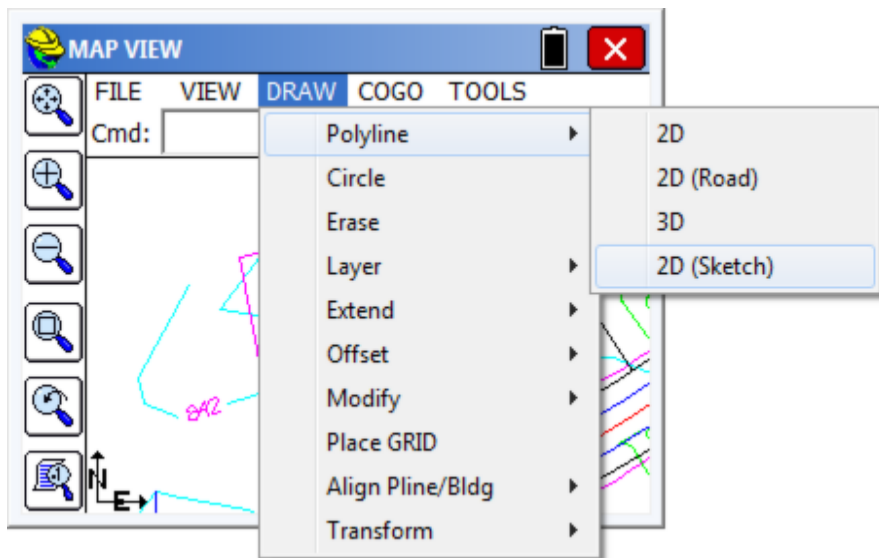
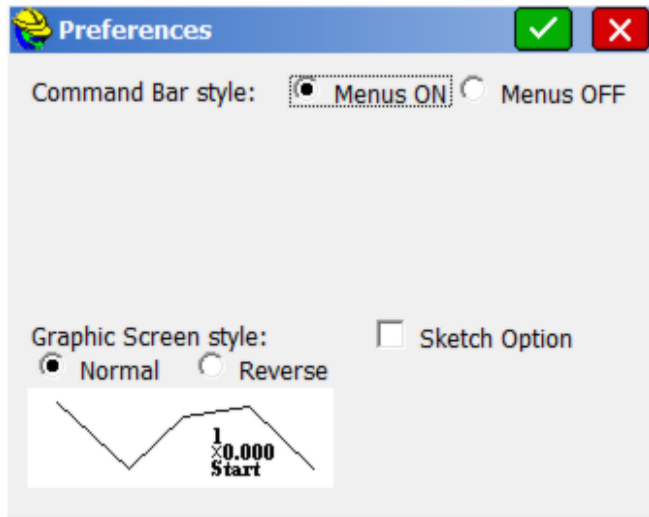

When the 2D Sketch is selected, then there is a snap option to pick in blank space on the screen, the snap to the right, seen as a "?". Any polyline drawn with the sketch "?" snap can be used for stakeout using conventional snaps. So you could draw a new 2D Polyline to divide lots 78 and 79 by snapping to the back property line (Nearest), picking a "?" sketch snap in the middle and ending with a perpendicular snap to the lower property line, as shown below. Then you could stake out the sketched point (pencil below) using the endpoint snap.

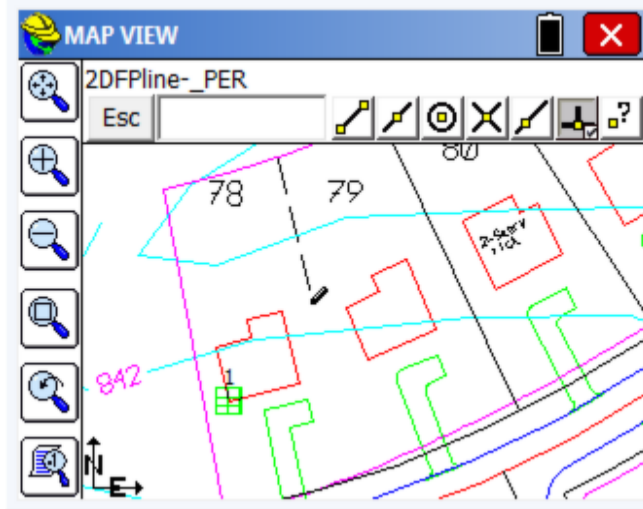

Command Aliases (AL):

Brings up a list of commands in the MAP mode for which the user can substitute an alias. If you would prefer to type A for Area rather than AR, you can substitute "A" as an alias for AR. Three commands will not accept substitutes: Inverse, Traverse and Sideshot (I, T and S). In addition to commands, you can toggle over to the "Linework special code" option, and substitute aliases codes for the default special codes such as PC, PT and END (used to control linework using feature codes). As an example, you could choose the "X" or ".." to End a line, or use "CS" for curve start instead of PC. A list of MAP commands is shown below:

2D Polyline
 Bearing and 3D Distance
 3D Polyline to Profile (.pro)
 3D Polyline
 Aliases
 Align Building 1-Segment
 Align Building 2-Segment

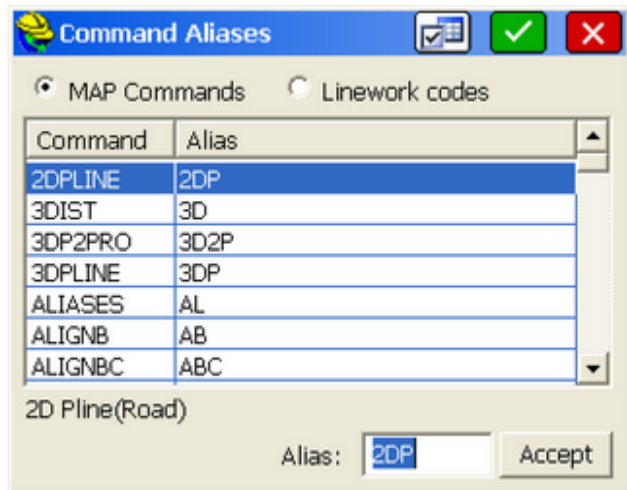

Align Building Settings
 Aperture Size
 Compute Area
 Chain of Polylines to LandXML
 Change Layer
 Draw Circle
 Centerline (.CL) to Polyline

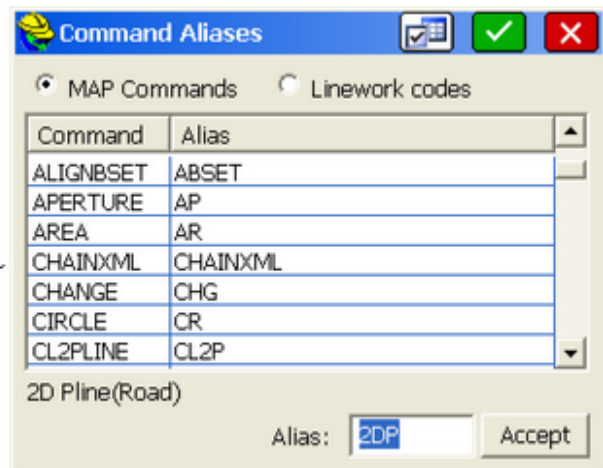

Converts 3D to 2D
 Copy Entities
 Copy GIS Data
 CRD Points to LandXML
 Curve Calculator
 Delete Layer
 Line or L-Figure to Building

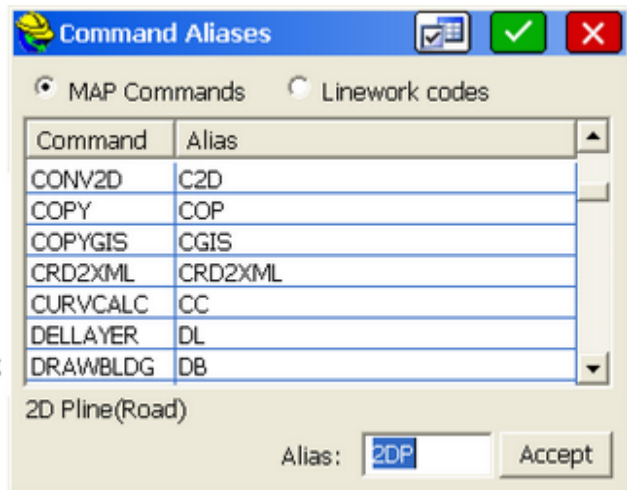

Draw/Locate Points
 Draw/Import Moss File
 Draw/Import PLN File
 Edit Polyline
 Erase Entity
 Exit
 Export Shapefile

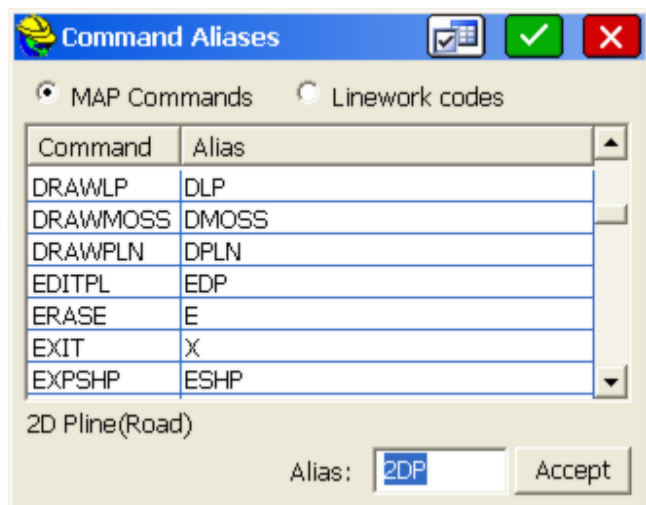

Quick Export Shape File
Export .dwg File
Export .dxf File
Reprocess Field-to-Finish
Fillet 2 Lines--Create Curve
Find Point
Help

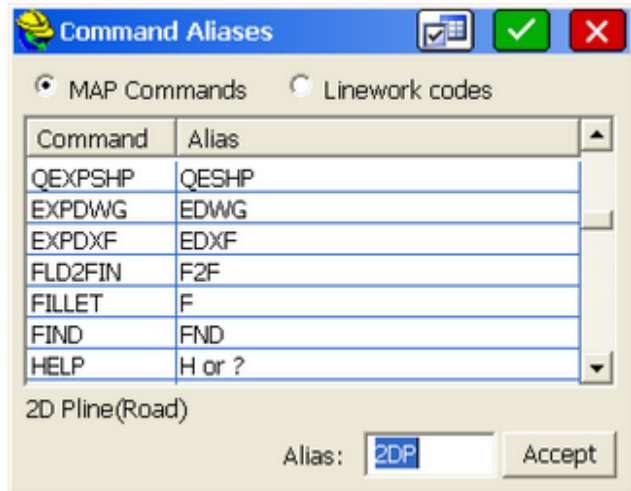

Hinged Area
Import DTM from DXF
Import Shapefile
Quick Import Shapefile
Import LandXML to CRD
Import .dgn File
Import .dwg File

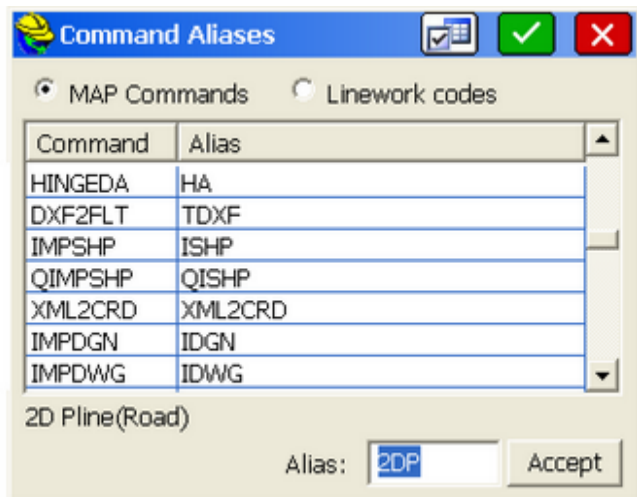

Import DXF File
 Edit GIS Data
 Inverse (Distance)
 Isolate Layer
 Isolate Points
 Report Deflection in Plines
 Join Polyline Segments

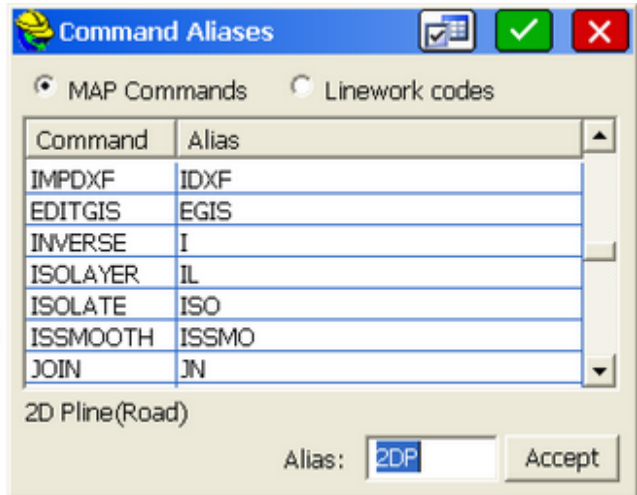

List Entity/Report Layer
 List Elevation
 View Layers
 Mirror Entity
 Move Entity
 NGS Query for Control Pts
 Offset Type

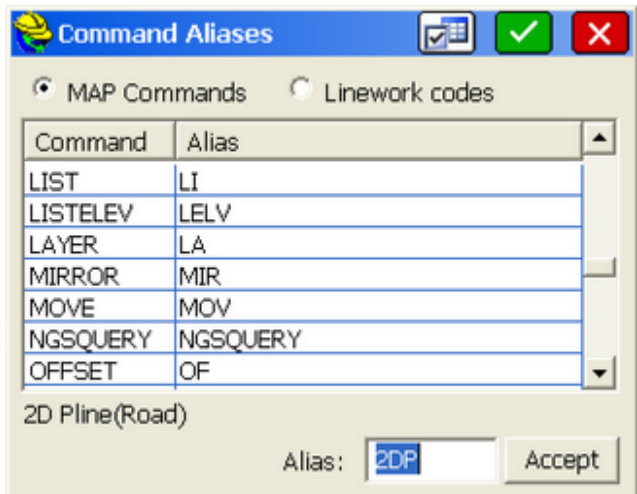

Offset 2D
Offset 3D
Buffer Offset
Segment Offset
Traverse Defaults
2D Polyline
Polyline to Centerline File

Command Aliases

MAP Commands Linework codes

Command	Alias
OFFSET2D	O2
OFFSET3D	O3
OFFSETB	OBUF
OFFBYSEG	OSEG
TRDEF	TD
POLYLINE	PL
PLINE2CL	P2CL

2D Pline(Road)

Alias: Accept

Polyline to Points
Quick Save
Remove Arcs
Reverse Polyline Direction
Rotate Entity
Copy CRD File
Scale Entities

Command Aliases

MAP Commands Linework codes

Command	Alias
PL2PNTS	P2P
QSAVE	QS
REMARCS	RMA
REVPLINE	RV
ROTATE	ROT
SAVEASCRD	SCRD
SCALE	SCL

2D Pline(Road)

Alias: Accept

Scale Bar On/Top/Off
Sideshow
Sliding Side Area
Slope Report
Traverse
Triangle Calculator
Triangulate & Contour

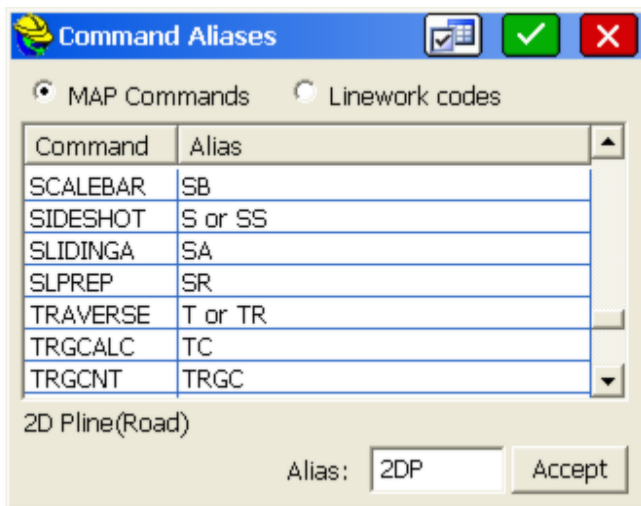

Trim
UCS Icon On/Off
View Options
Zoom
Settings (Preferences)
Divide Polyline by Segments
Divide Polyline by Interval

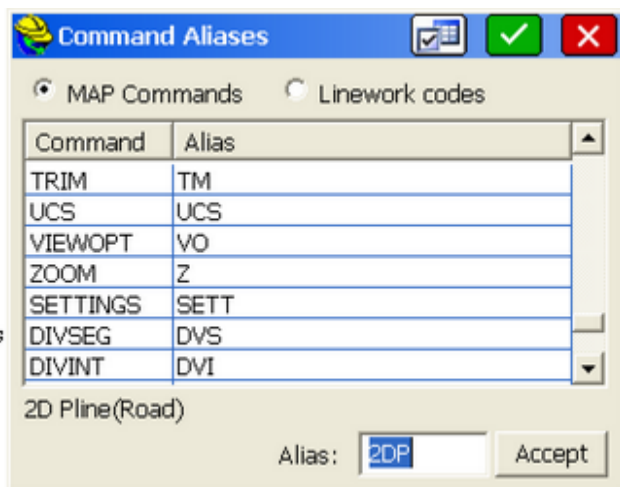

Export DTM to LandXML
 Import LandXML to DTM
 Image Overlay
 Export GIS to ASCII TXT
 Draw Grid

Extend by Distance
 Extend to Edge
 Volume Report

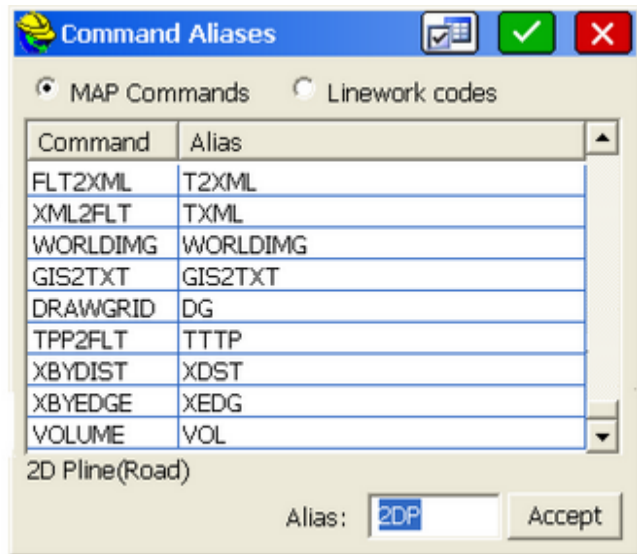

Linework and special "field-to-finish" codes are shown below:

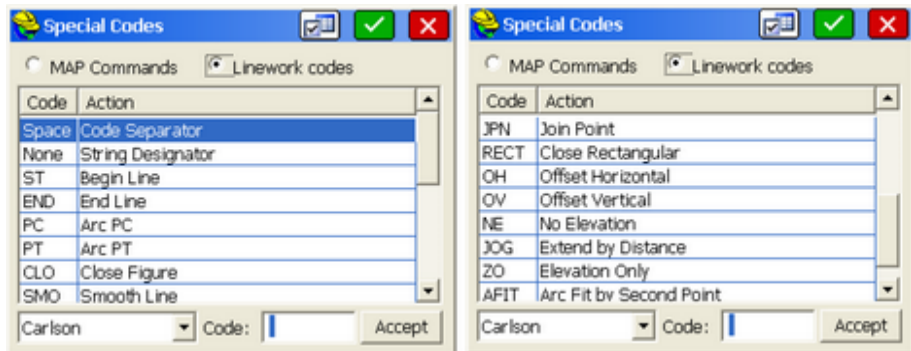

The Settings button at the top of the screen applies to field-to-finish coding and is covered in the Feature Code List feature within the File menu.

Quick Save (QS):

Saves the current DXF file without prompting for the file name.

Save As(CRD):

Saves the current coordinate file to the location you choose as a backup copy.

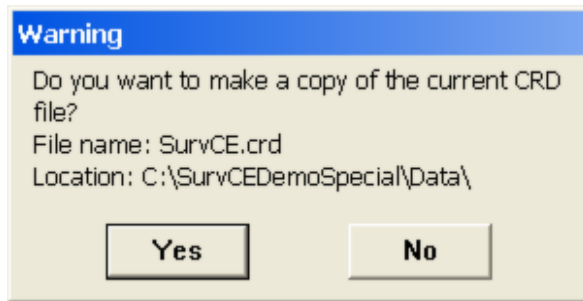

Draw MOSS File (DRAWMOSS):

This will import and draw a MOSS ".inp" file.

Draw PLN File (DRAWPLN):

This will import and draw a Carlson PLN file, which is a file of polylines and converted text, created in Carlson Survey or the Carlson Civil Suite.

Exit (X):

This exits the MAP and CAD session and brings you back to the Menu screen.

Help (H):

Launches the interactive Help screen describing various MAP screen commands. Scroll up and down to review. With wireless on, includes access to Internet Explorer, by tapping the icon at the top of the Help screen. The Help screen is an HTML file which will appear if loaded on the data collector.

VIEW

The View menu is found next to the File menu in MAP view. Below you will find each feature described.

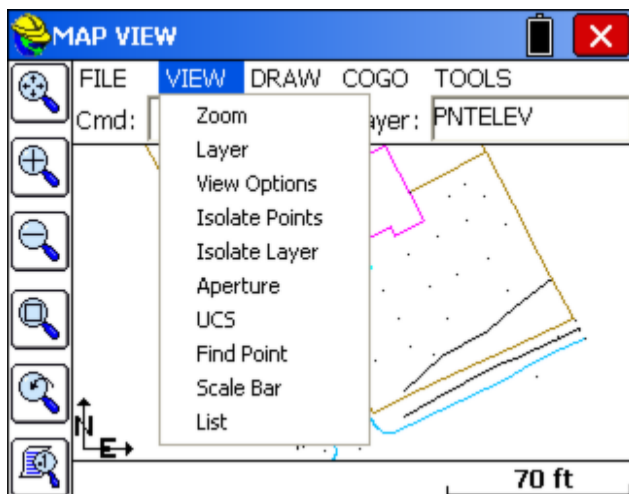

Zoom (Z):

Increase or decrease the apparent size of polylines and distances between points, in drawing area. The specific options in the command are N (Zoom to Point ID/Number, enter zoom magnification), I (Zoom In), O (Zoom Out), W (Zoom Window), P (Previous) and E (Extents). The Zoom command options can also be accessed using the first 5 buttons from left-toolbar menu. The order of buttons, starting with the first top button, is: Extents, In, Out, Window, Previous. Zoom Previous will "nest" which means that if you Zoom In or Zoom Window 3 times, each Zoom Previous takes you back one step and 3 Zoom Previous commands would return to your original view.

Layer (LA):

This command manages layers and layer properties.

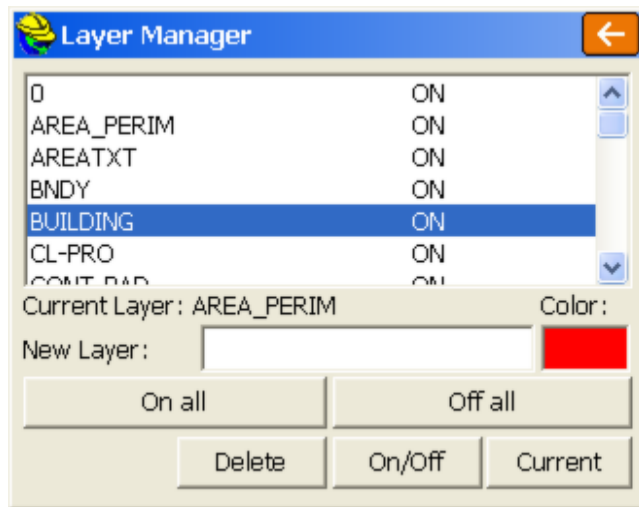

To add a new layer: Type in a new name into the New Layer edit box. The New button will appear at the bottom. Tap this button. If you type in a new layer name and the New button does not appear, then the layer name you entered contains invalid characters.

To set a layer current: Highlight the layer name in the list and then tap the Current button. You cannot set a layer current if that layer is turned Off. Turn the layer On first and then set it current.

To delete a layer: Highlight the layer name in the list and tap the Delete button. You cannot delete layers that contain objects. If you select a layer and the Delete button is not visible, then this layer contains objects.

To turn a layer On/Off: Highlight the layer name and tap the On/Off button. Objects on layers that are On will be visible, objects on layers that are Off are not visible.

On all: This button will turn all layers on

Off all: This button will turn all layers except the current layer off.

Color: Clicking on the color bar will bring up the color palette allowing you to set or change the layer color of the highlighted layer.

One of the main purposes of the Layer command is to permit the import, by DXF, of a drawing containing all possible polyline work to stake out (set out). Then you can reduce clutter on the drawing by turning layers off, leaving only the layers you want. You can stake any endpoint, intersection, or other location on the polylines using "snaps" without creating point numbers. You can also do the MAP command Cogo, Interpolate Points, Polylines to Points and make point numbers out of all vertices (corners) of polylines where you need to set stakes. Then proceed with Stakeout by Points.

View Options (VO):

This command controls the appearance of point objects on screen. This is exactly the same as touching the lower left graphic icon. The routine displays the View Point Options dialog. Pt#, Description and Elevation toggles control whether these attributes are labeled with the points. If Freeze All is on, the points are placed on the map, without attributes. Available point symbols are: ".", "+", "x". The "Decimal is point location" toggle determines if the decimal point used in the display of elevations represents simultaneously the point location and symbol. This slightly reduces screen clutter. Turning on the WCS Icon and Scale Bar would show the north direction and graphic scale at all time in the MAP view. Turning them off also reduces screen clutter.

Small and Large toggles determine the size of font used to display the point object on screen. Set Color Attributes brings up the color palette (available only on color CE devices). This lets you choose the color of the point symbol, elevation and description text. Traverse Defaults is found under the Data tab, which also includes the "Intelligent Zoom" toggle ("on" setting recommended). The Traverse Defaults button brings up a dialog that has the settings for prompting each time for instrument and rod height and the vertical angle. This applies to the T for Traverse and SS for Sideshot commands that allow point calculation within the MAP Screen. For Cogo work, turn off Instrument/Rod Height and Vertical Angle prompting. For manual entry of actual field measurements, turn them back on.

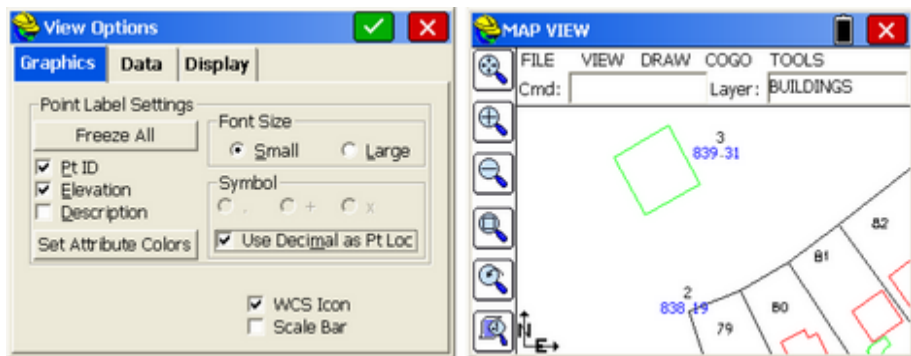

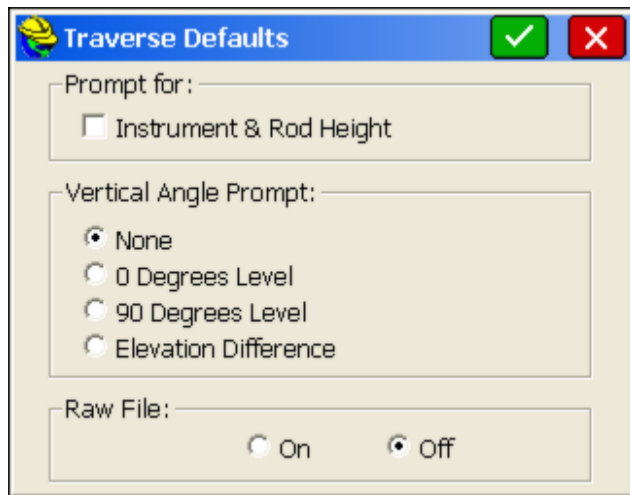
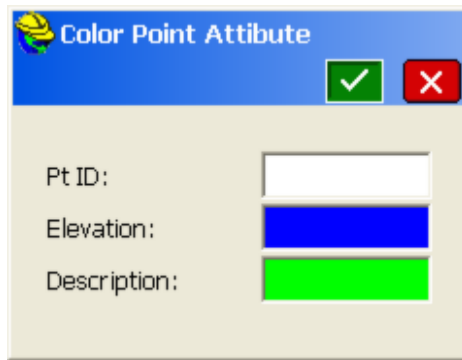

The Display tab is covered in the Map-Basics section of the manual, and allows for rotation of the map screen to any cardinal direction (N,S,E,W) and also allows mirroring of the screen. These screen views carry forward into all survey and stakeout screens involving graphics.

Isolate Points (ISO):

This is another useful command to reduce screen clutter. If you have 500 points on the screen, you can isolate to only those points you wish to see, by entering a distinct point range, in the form 1-10, 22, 25-30, or a certain description. This would isolate to points 1 through 10, point 22 and points 25 to 30, and other points are “frozen”. You can also isolate to descriptions (D for Descriptions) by entering a description such as "EG" for Existing Ground or a wildcard description using an "*" such as "IP*" for any description beginning with IP (IP, IPF, IPS, etc.). Repeat the ISO command and enter the full point file range (or “all”) to restore all points.

Isolate Layer (IL):

Select any polyline layer and isolate it to keep that layer. Other polyline layers are turned off (frozen), but point layers are retained. Use the Layer command to turn layers back on as needed (On All).

Aperture (AP):

Controls the size of the rectangle area used to select points or polylines from screen. Initially, the size in pixels is 20 units for points selection and 10 units for polylines selection. You can change it as shown. The routine displays the Aperture size dialog.

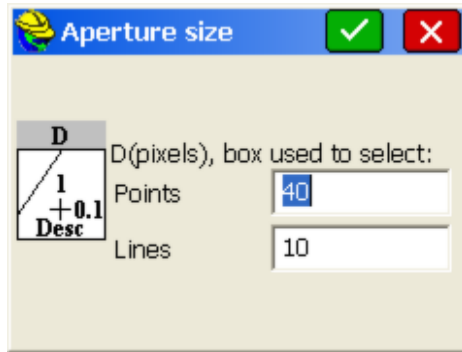

UCS (UCS) User Coordinate System Indicator:

This toggles the visibility of the UCS icon shown in the MAP screen. Also can be done in the View Options command or through lower left icon in Map screen.



Find Point (FND):

This command allows you to find a point on the MAP screen. Enter the point you want to find and a zoom height. If you enter a point that is not on the map, the dialog will warn you and allow you to enter another point number.

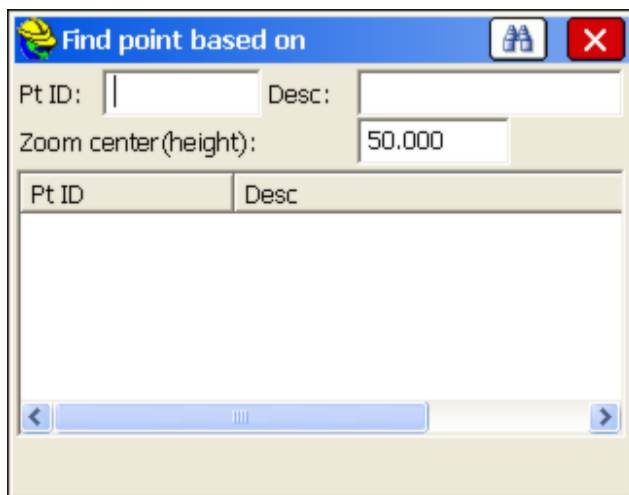

Click Find and the SurvCE zooms to the selected point at the entered scale.

Scale Bar (SB):

This toggles the visibility of scale bar on or off. The scale bar is normally shown at the bottom of the MAP screen. The "onTop" option places the icon on top of the Map View saving maximum space for the graphics:

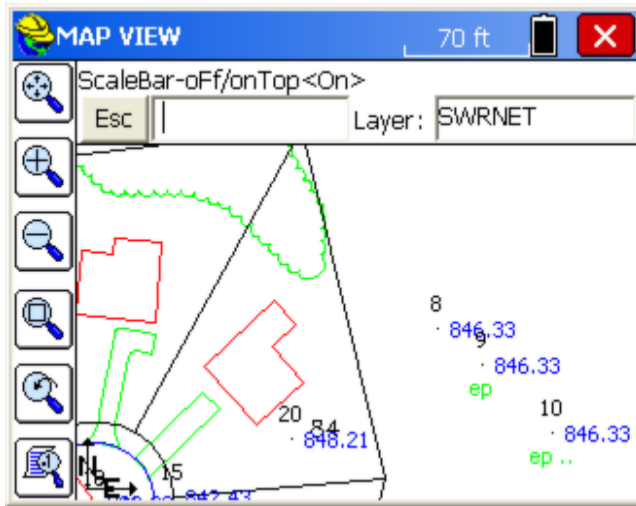

List (LD):

Applying to linework entities only, this lists the layer, 2D or 3D status, Closed or Open status, perimeter (length), and area or projected area (if not closed). The coordinates of the polyline are shown including the elevation:

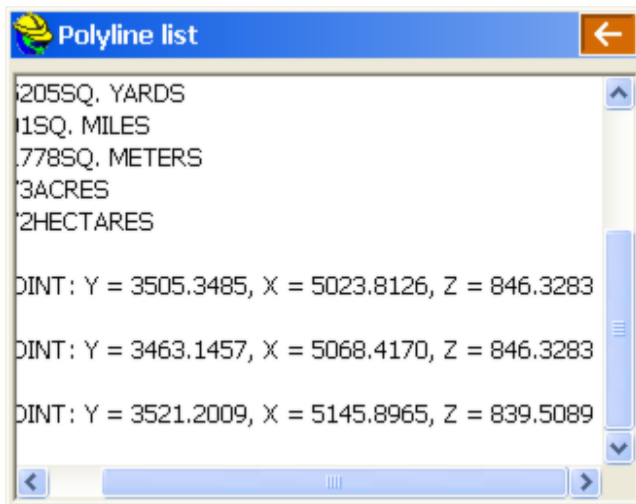

DRAW

The Draw menu is found next to the View menu in MAP view. Below you will find each feature described.

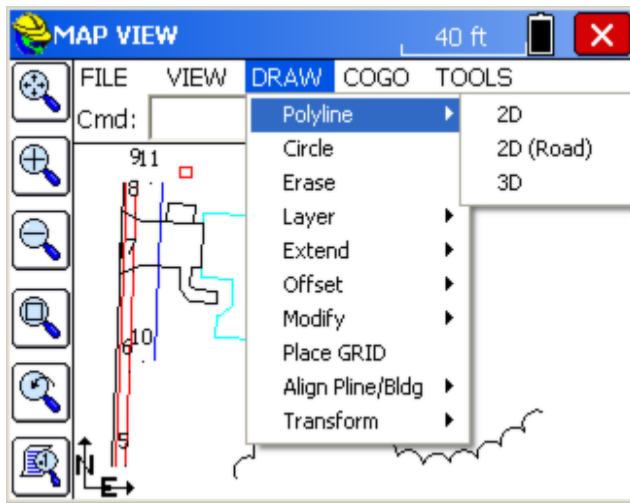

2D Polyline (PL) (AutoCAD style):

This command allows you to pick points from the screen or type in point numbers or snap to line segments. The snaps appear as icons (see below) and include, in order, left to right: "Endpoint," "Midpoint," "Center of Arc or Radius Point/Block Insertion," "Intersection," "Nearest," "Perpendicular," and "Tangent to Arc." The "Nearest" snap will simply pick a point on any line or arc you select, at the nearest point to where you pick. First, pick your starting point then you have several options on the command line. You can also draw by point number and even use ranges, as in 8-10,37 which would draw sequentially from 8 through 10 then to 37, as shown below.

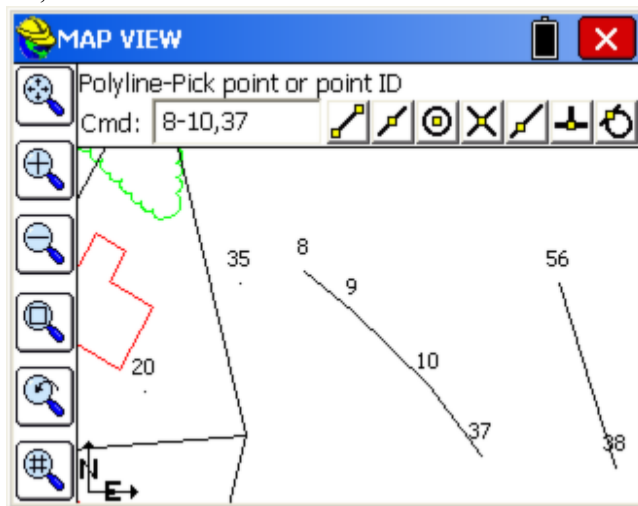

Points can be entered or picked from the screen. The default option is to keep

picking points and the other options are described below.

Cmd: Polyline-Arc/Close/Undo/<End>

A: Starts an arc segment. See below for details.

C: Closes the polyline (you must have at least two polyline segments drawn before you can close)

U: Will undo the last segment drawn (you can Undo again and remove multiple segments)

E: Will end the Polyline command. Since it is the default, Enter will also end the polyline.

ESC: This will cancel drawing of the polyline.

Constructing an arc segment

After choosing A, the command line will change to:

Cmd: Polyline-Arc CEn/Len/Sec/<Rad>

You have various options for constructing an arc as part of your polyline.

CEn: Allows you to specify the center point (or radius point) for the arc. After picking the center point, you must specify the arc end point and then the arc direction.

LEn: Allows you to specify the arc length. First you pick the arc end point and then you can enter the arc length. The minimum arc length is given to you.

SEc: Allows you to specify the second point and end point to define the arc.

Rad: Allows you to specify a radius length. First you pick the arc end point and then you can enter the radius length. The minimum radius length is given to you.

2D Polyline (Road) :

This command allows you to draw a 2D Polyline. You can draw by point number, with ranges as in 8-12, or by picking on the screen using snaps or picked points. This command is similar to the polyline command described above with the following additions:

+/-: The +/- options activate an additional prompt that allows you to plot line segments at a 90 degree deflection angle from the last line. [+] is a right deflection and [-] is a left deflection.

Len: This option prompts you for the length of a line segment. Enter the length and a line segment will be drawn that length using the same bearing as the previous line segment. If the previous segment is an arc, then the new segment will be tangent to that arc.

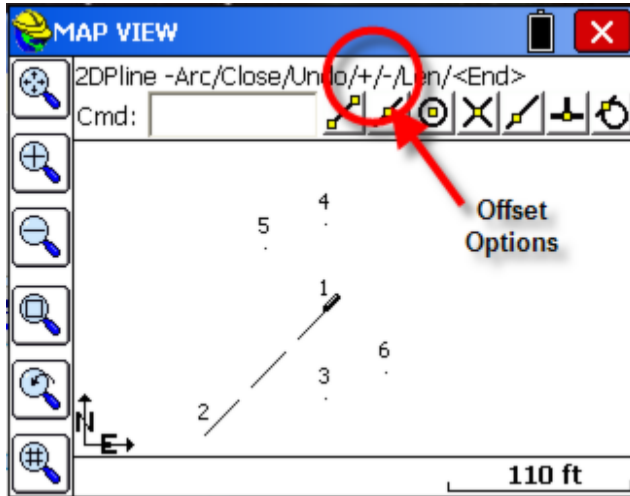

3D Polyline (3DP):

The 3D Polyline command is similar to the 2D polyline command. It will even draw arcs, but will create a polyline on the screen with many vertices at different Z elevations which are linearly interpolated around the arc. If the start of the arc is point 17 at elevation 842.246 and the end of the arc is point 9 at elevation 839, then using View, List, you would see intermediate vertices (note that the segment length between vertices is about 0.12 units in this case).

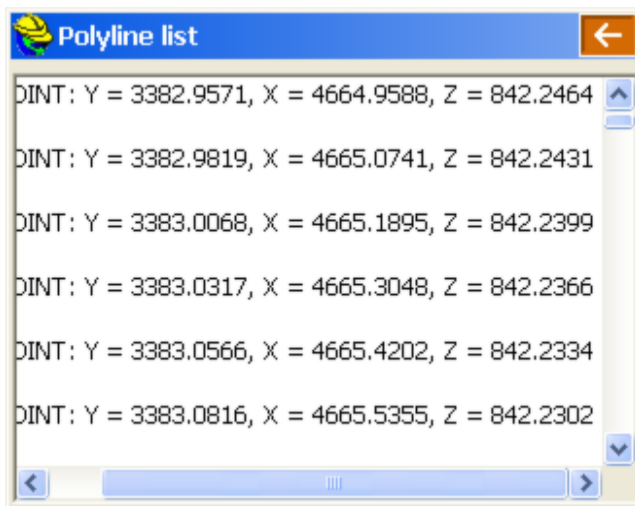

Using the snaps to draw lines can accomplish advanced coordinate geometry calculations. For example, if you offset two polylines and wanted to determine the point where the offset lines intersect as well as the corner of the driveway, you could draw a line from intersect to endpoint and do the command Polylines to Points (COGO, Create Points), which would create points 50 and 51. Polylines to Points will not find intersects, so it is more direct to simply do Draw Locate Points and use the intersect snap to create point 50 (COGO, Create Points).

These procedures avoid complicated COGO involving curve-line intersects at offset. If your goal is to stake out points, you do not even need to create Point IDs, since the comand Stake Points will locate points by snap, directly fromthe drawing.

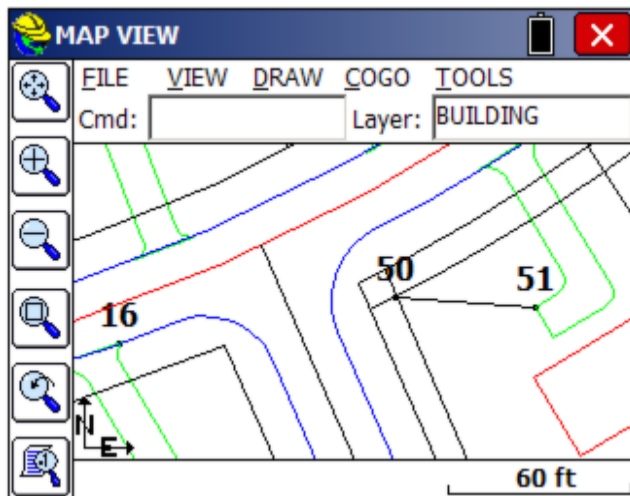

Circle (CR):

This command draws a circle entity, based on diameter defined by two points or based on a center point and a radius. You can select and erase the circle with the command E for Erase. The circle is considered a polyline.

Erase (E):

Erases all selected polylines. It will not erase points. Note that you can erase an entire area by selecting a Window through the polylines (picking first a lower left point in "blank space", then picking an upper right point). If you even contact or enclose any polylines with this window selection, they will be erased. So the "window" erase procedure mimics the "crossing" selection method of AutoCAD (r). If you enter "All" at the Cmd prompt, you will erase all linework. There is no Undo, so this would be permanent for that Job. However, you can redraw any linework created by Feature Codes, using MAP, Tools, Field to Finish.

Delete Layer (DL):

Select from a list one or more layers, or select "From Screen", then the routine will delete all the polylines on those layers. If you entered C* at the lower line, the entities on all layers starting with the letter C would be erased.

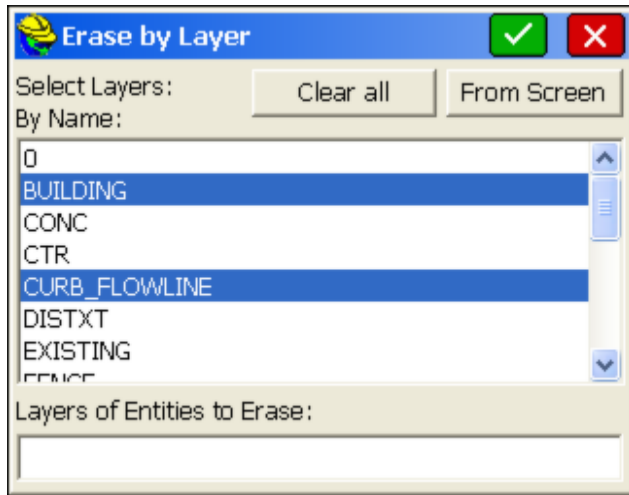

Change Layer (CHG):

This changes the layer of the selected polylines. One form of selection is to type L and press Enter in order to select last created polyline from the drawing. The routine displays the "Change entities to layer" dialog box. When the dialog appears on the screen, the selection in the layer list will be set to the current layer. Pick another layer to change layer. Clicking the color bar (where it shows "bylayer") brings up the color palette, letting you change the color by picking or ByLayer. So you can change the layer of a selected polyline or you can keep its layer and just change its color.

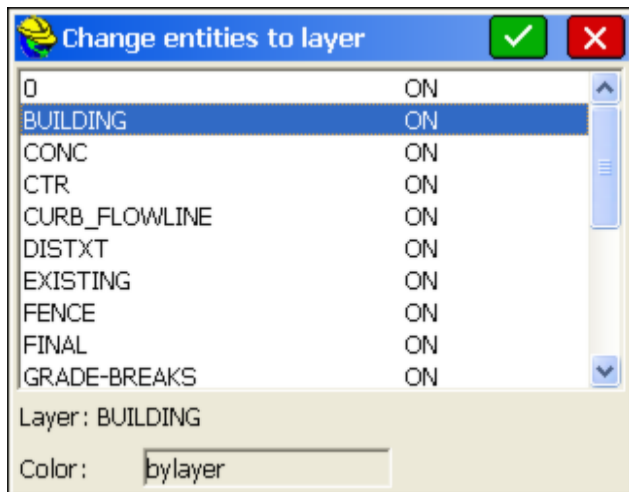

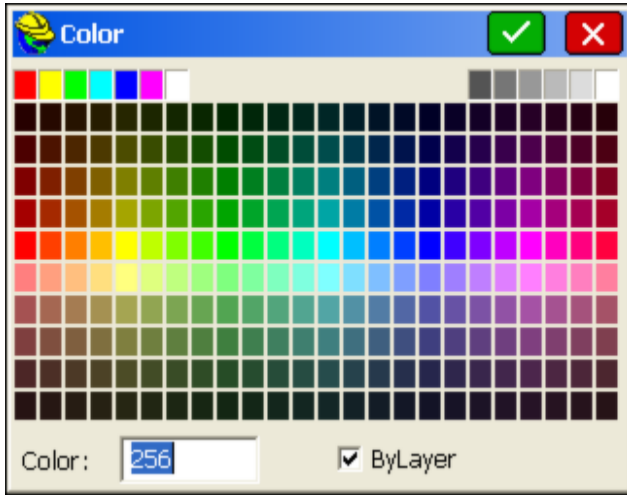

Extend - By Edge (XBYEDGE): First select the line to extend to, then the line you wish to lengthen and extend. In the example below, pick the line at left first, then the short line to extend second, and you obtain the result. There is a U for Undo option if you do not want to keep the extended line.

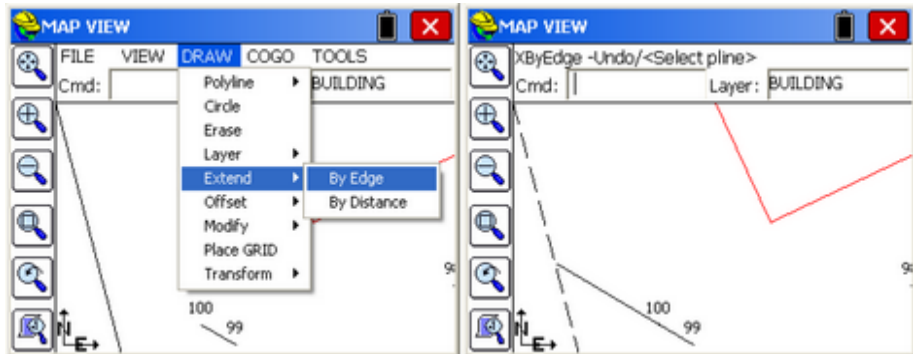

Extend - By Distance (XBYDIST): This powerful command allows you to create figures such as buildings, walls and other linear features that can then be staked out or used simply as a graphical reference or for additional CAD operations like offsets. If the distance from 99 to 100 is 7.07 feet, and you wish to make an L-shaped building that continues past point 100 for a total distance of 10 feet then goes 15' right, 20' right, 10' right, 10' right and closes, this is done with the following entries:

XBYDisT-Last/Points/<Select Polyline>: Press Enter to Select a Polyline and then pick, towards point 100, the starting line segment. The arrow will appear towards the picked end. If you get Point Details, you have not pressed Enter to "Select Polyline".

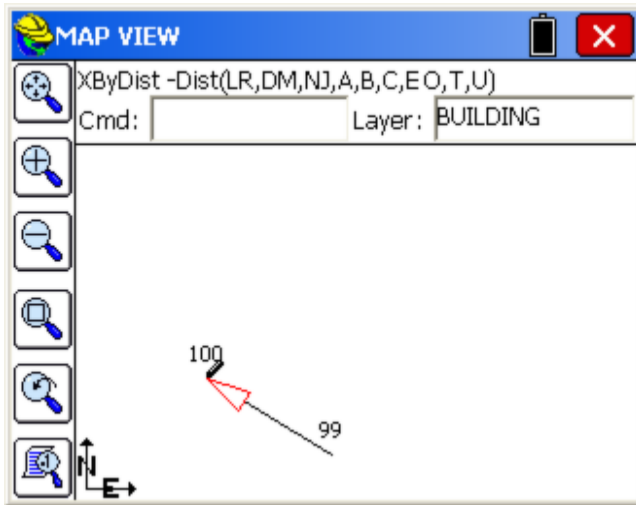

Then enter T for Total Distance (program displays current distance of 7.07), then 10 (the additional 2.93 feet is drawn), then R for Right. The arrow then turns to the right. Then enter 15 then R, then 20, R, 10, R, 10, then C to close.

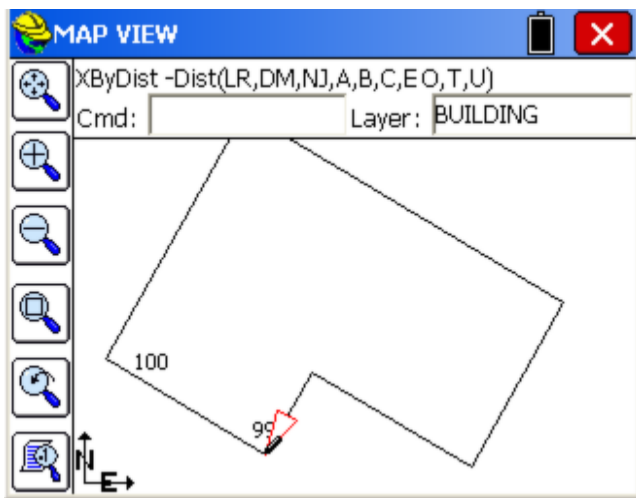

The full list of options are:

L for Left, R for Right (two L's or two R's would reverse the direction of the line)
M for Move: Moves without drawing. Acts like a "pen up". You can then enter left and right distances.

D for Draw: Draws after a Move. Acts like a "pen down". Distances entered will draw.

N for Number: Creates point numbers at the vertices and numbers from the end of the job file.

J for Jog: Turns off point numbering and goes back to simple "jogs" of line segments. This is the default condition.

A for Arc: Draws arcs based on radius point and end point or radius length and end point.

B for Bearing (-aZi/Brg/ToPoint/<Ang>): Entering 45 turns an angle of 45. B for bearing allows bearing entry in all modes accepted by SurvCE, such as N34.15E. You can also draw by azimuth or to a point ID.

C for Close: Used in the example above to close to point 99, the starting point.

E for Extend: Will extend the line to any selected polyline.

O for New Polyline: Starts a new polyline and creates a separate entity, even though the figure will appear continuous.

T for Total Distance

U for Undo

Esc will exit the command at any point.

Offset Settings (OF):

This command allows you to set the type of corner that SurvCE should create when offsetting entities.

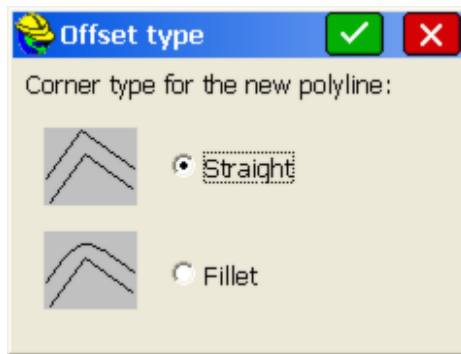

Offset - 2D (O2):

Mimics the AutoCAD (r) Offset command, and only works with 2D polylines. Enter the offset distance and pick the left or right offset amount. The building pad at left in the graphic associated with Segment Offset was offset 10 units in the outer direction, for example. The 2D and 3D offset commands have the option to fillet the corner (create arcs of radius equal to the offset distance) on exterior offsets based on Offset Settings under the Tools pulldown menu. This exterior offset with arc is sometimes referred to as a "buffer" offset, in that all points on the exterior offset are exactly the same distance from the source polyline. Buffer offsets are sometimes used for easements or GIS applications. Offsets to the interior will not create arc segments.

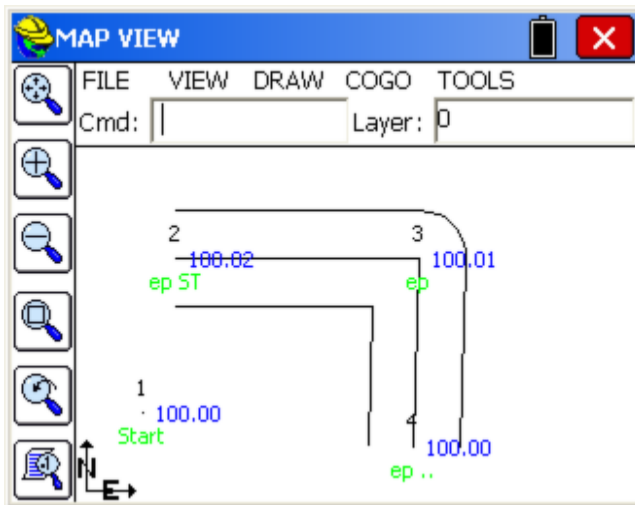

Offset - 3D (O3):

This offsets 3D polylines both horizontally and vertically. It is great in combination with road/utility centerlines to create offset polylines to stake. It can be used for ditch lines, curbs, walls and many other applications. The standard offset method is "Interval". In the case below, a 3D polyline for edge-of-pavement (EP) was offset Horizontally 0.2 then Vertically 0.5 for top of curb, then offset again 4.5H and 0V for outer edge of sidewalk. These three 3D polylines can then be selected in Stake Road, option "Cut from Alignments" and then with the outer sidewalk edge selected as the "centerline", the stakeout screen would appear as shown below (exaggeration 4x):



Using the "Interval" method (normal method), vertical offsets can be by elevation difference (default), or by slope percent or ratio. The default "Continuous" option keeps the offset 3D Polyline as a single entity. If you do the "Segment" option approach, only the segments of the 3D polyline will offset (leaving gaps), and you have the option to create Point IDs on the offset vertices.

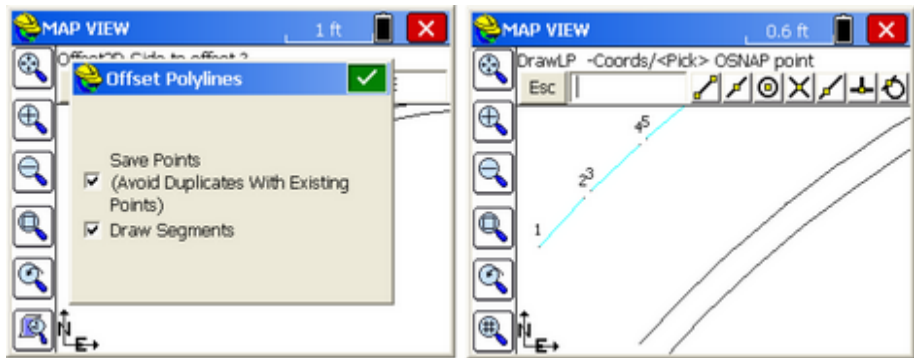

The "Constant" option takes a 3D polyline and offsets it to a constant elevation for all vertices. So if you measured the base of a retaining wall that sloped downhill, but the top of the wall was a constant elevation, you could offset a fixed horizontal distance to that single elevation.

Offset - By Segment (OSEG):

This offsets all vertices of each segment of the polyline in a 90 degree offset and will draw line segments or optionally create points at the offsets. This is shown at right (in contrast to the parallel line offset at left) in the graphic below. You begin by entering the offset amount (eg. 10). Then a dialog appears with options to Avoid Duplicates and "Erase All", which removes the line segments and leaves only the points.

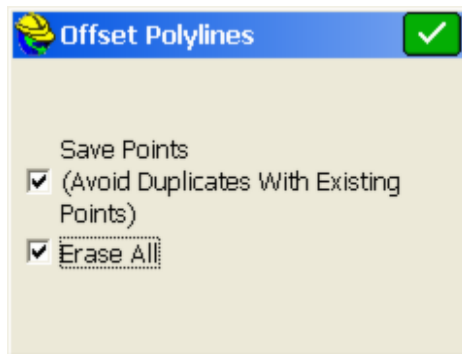

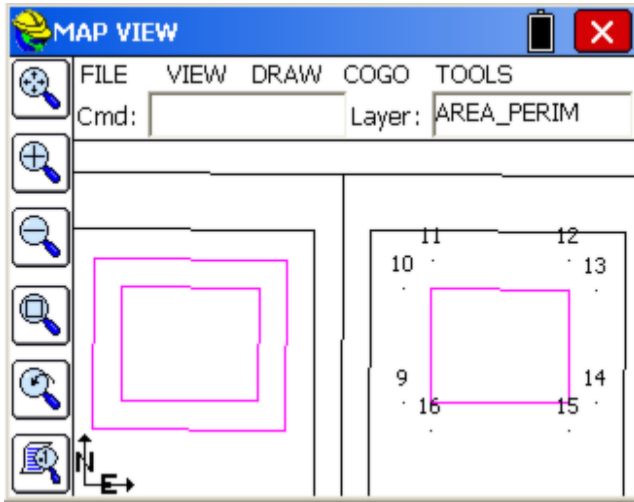

For L-shaped buildings or figures with angles, an additional interior offset point is calculated at the intersect of the parallel offset lines based on the entered offset distance, such as 10 (see point 165 below--the lines to 165 are drawn only to illustrate the 10' offset):

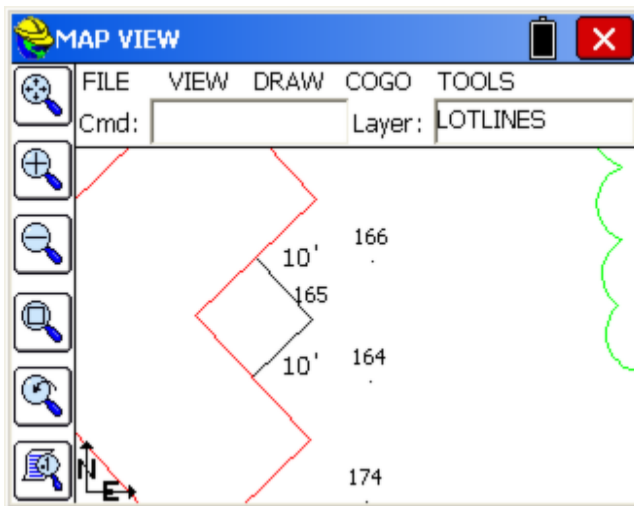

For L-shaped figures, offsets are also projected through to the other side, so that the offset for point 174 appears across the building, for purposes of pulling a stringline.

Offset - Buffer Offset (Offsetb):

Pick any closed figure or multi-sided figure and you can offset, typically to the outside, using a rounded radius corner, such that all points on the offset line have the same distance from the nearest point on the figure. An offset of 2 units was used below on the closed polyline shown, using Buffer Offset.

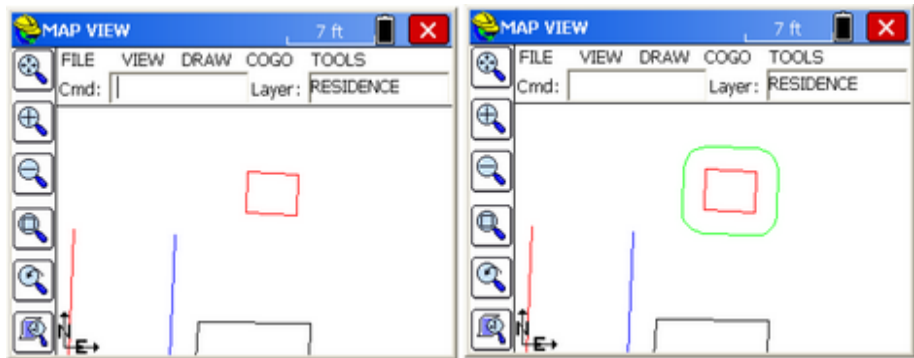

Offset - 4 Sided Building (DrawBldg):

Sometimes it is possible only to measure 3 points on a rectangular building. If you connect the 2 sides with a 3-point polyline, you can click on the building using the command Offset, 4 Sided Building, and create the missing 2 sides.

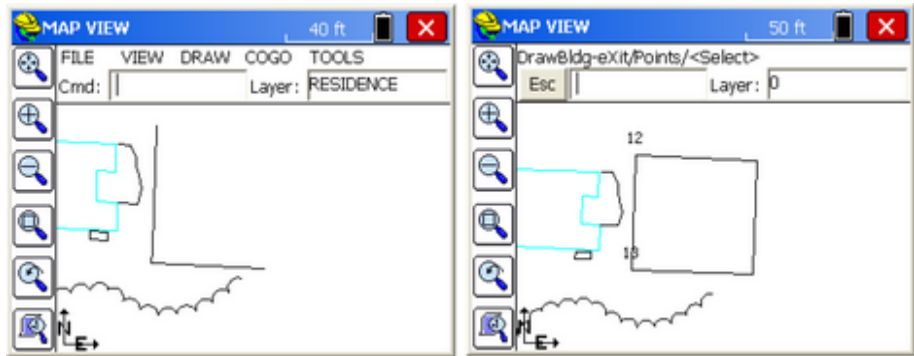

You can select by tapping the building or choose "Points" to enter point 12, 13 and snap the endpoint of the 3rd side, for example. If you have only measured 2 points for a rectangular object, the command will still work--it will prompt for the offset distance (positive is to the right, negative is to the left) and create the 4-sided building or object. You will get a warning if a picked polyline has more than 3 vertices--in that scenario, use the "Points" object to pick the 3 corners of the building.

Modify - Remove Arcs (RMA):

Pick any polyline with an arc, specify the "offset cutoff" spacing, and turn the arc into chords. Offset cutoff refers to the maximum separation between the chord and the original arc. If you enter a small cutoff distance of 0.1, then at no point do the chord segments differ from the arc than 0.1. Be careful with this command – there is no "Undo" to restore the arcs (though you can immediately start a new job and "re-load" the last, saved DXF file of the drawing). After removing arcs, you can draw a polyline from points on the arc, after creating small chords, using the "endpoint" snap (first snap on the left in the list of snaps).

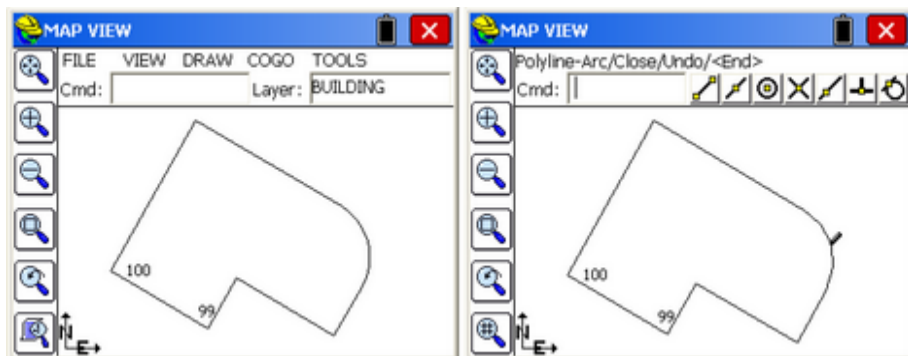

Modify - Fillet (F):

Similar to AutoCAD's Fillet command. It prompts: Cmd: Fillet -Ra/PI/eXit/First seg 25.00. If you are trying to inscribe a curve at the corner of a polyline, you enter the desired radius first by selecting R for Radius (at the above prompt). Then you choose the P option. This leads to the prompt, Cmd: Fillet -Ra/PI/eXit/Select pl 25.00. Select the polyline near the vertex where you want the curve to go. This completes the process. If you wish to change the radius, enter R. If you want to fillet the corner of 2 distinct polylines, then just pick them as prompted (do not do the P for Polyline option). This command will only work with 2D polylines, completed with the command 2DP, or imported from a DXF file as 2D polylines, or converted from 3D using the command C2D which changes the vertex elevations to zero.

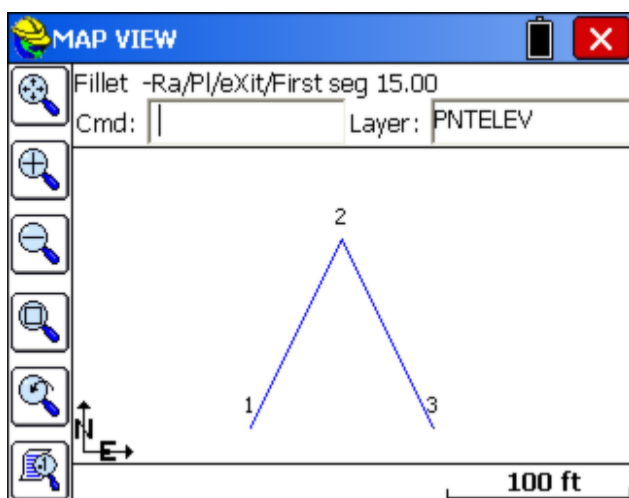

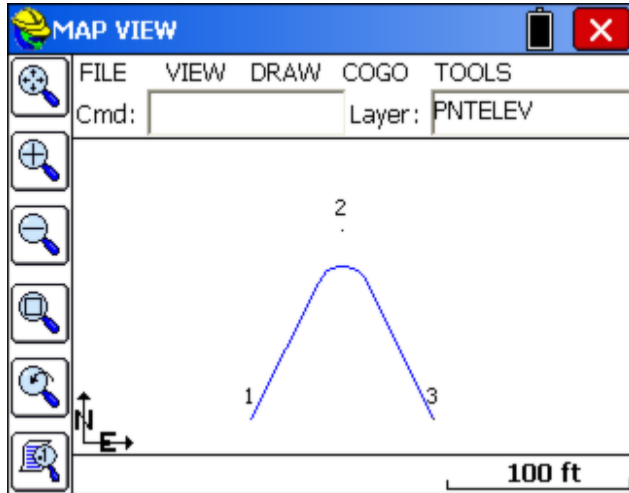

See the above two figures. Because in the top figure, from 1 to 2 to 3 was one continuous polyline, after the radius was set at 15, P was entered to set up the one-pick approach for polylines, leading to the completed fillet command and the result as shown in the bottom figure. Now you can do Cogo, Interpolate Points, Polylines to Points (P2P) and solve for the points for the beginning of the arc, radius and end of arc, for purposes of stakeout (set out).

Modify - Join (JN):

This command allows you to join polylines. Enter D to specify a new maximum separation distance, then select the polylines on the MAP screen. If you use 0 for Distance, then the polyline to join must be separate polylines connecting to common points. The advantage of joining polylines is that they can then be offset as a unit, and the vertices of the offset polylines can be turned into points for stake out. The offset command, in effect, does all the complicated bearing-bearing intersects for you. For example, if the resulting polyline were a pipeline with a 20 meter total right-of-way, then to stake the right-of-way points, you would offset the polyline 10 units left, then 10 units right, then turn both offset polylines into points, or directly stake by snapping to the offset polylines using endpoint and nearest snaps.

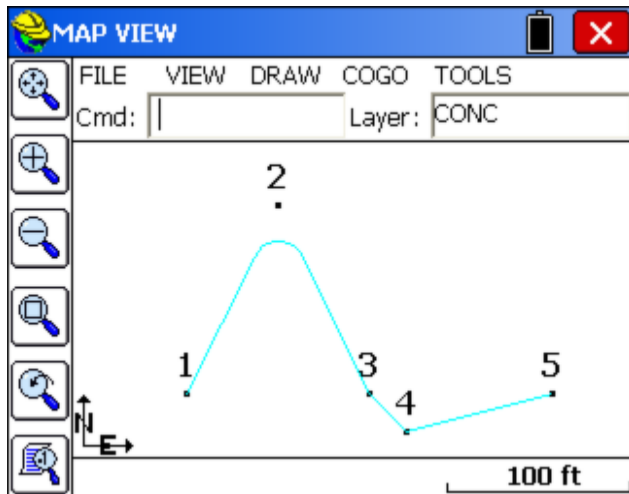
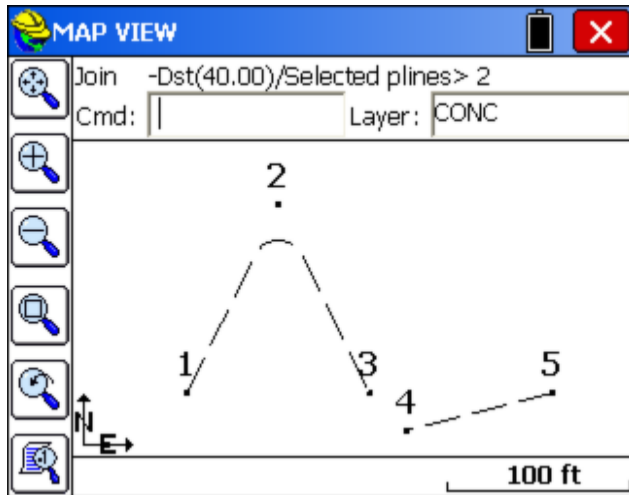

Modify - Trim (TM):

This allows you to trim polylines to the edge of other polylines just like in AutoCAD (r). Then the command Polyline to Points (P2P) will turn all vertices, including the trimmed end points, into points for stakeout.

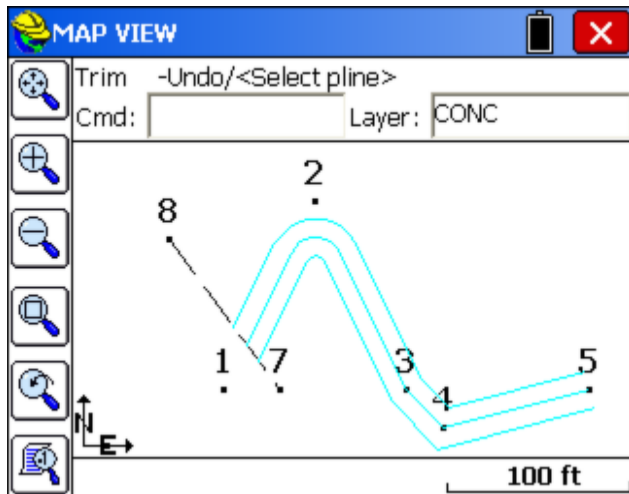
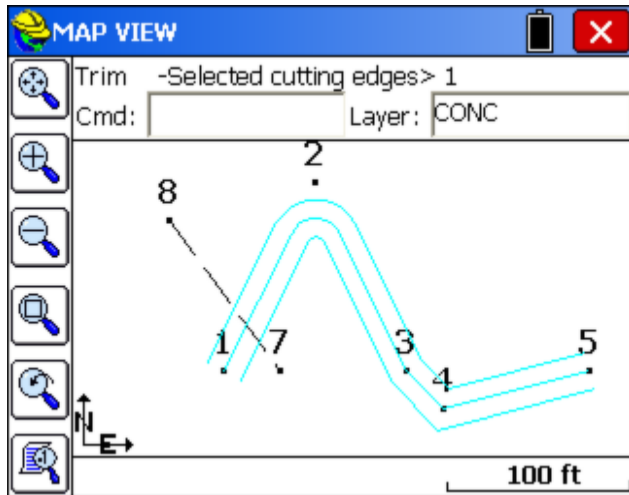

Modify - Reverse Polyline (RV):

When you turn a polyline into points, it will start the point numbering at the beginning of the polyline. Thus it may be useful to control the direction of the polylines for purposes of stationing and staking. This is done with the command Reverse Polyline. Each time you pick a polyline using this command, you reverse its direction, and little temporary arrows are displayed along the polyline indicating the current direction. If it is not the direction you want, reverse again.

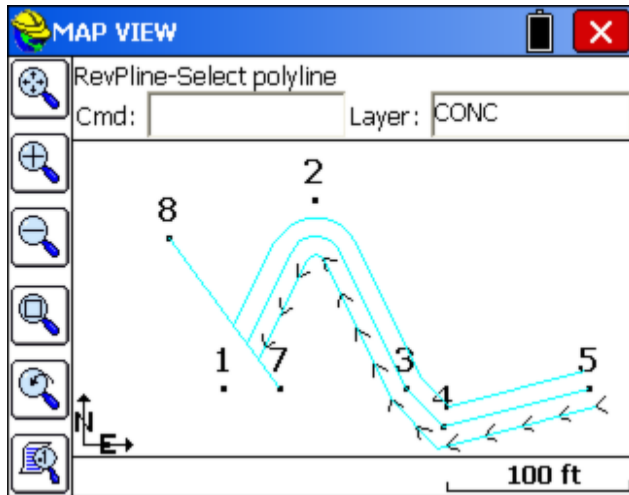

This command is useful to prepare for Stake Road using Cut from Alignments. The polylines for the various road breaks in grade need to be drawn in the same direction for "Cut from Alignments" (screen selection of 3D polylines) to work effectively. So in the instance below, if the alignment goes south to north (point 14 to point 15) and the ditchline polyline shown is drawn in the wrong direction, use Reverse Polyline to get its direction matching that of the main centerline. In this case, pick it one more time to reverse it so it goes south to north.

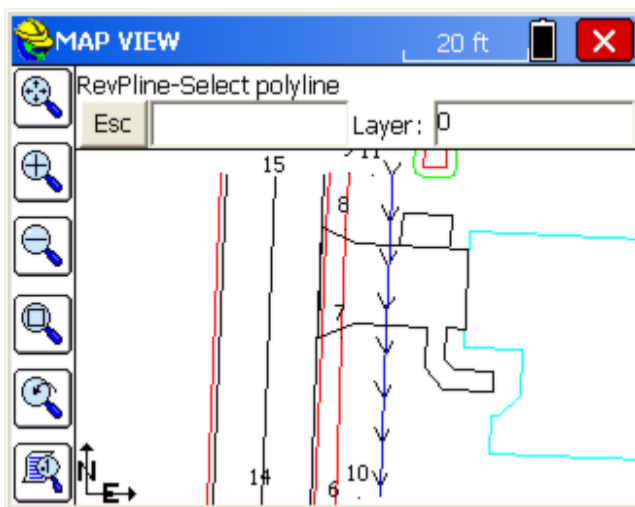

Place (Draw) GRID (DG):

This command toggles a horizontal and vertical grid display over your drawing, allowing you to set the grid resolution in drawing units. These grid lines are for reference only and are not part of the stored drawing associated with the job. To turn off, repeat the command and enter Off.

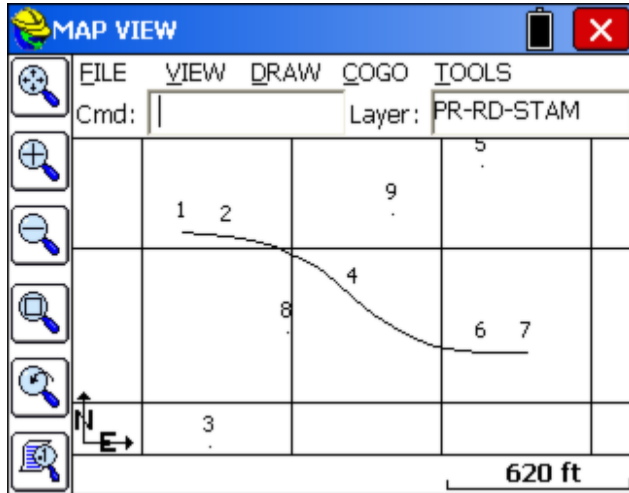

Align Settings (ABSET):

This command allows you to select between two methods of aligning buildings using the Align Building One Segment command under Draw, Align Pline/Building. The first method (offset-distance) aligns buildings parallel to the sideline based on a sideline offset and a distance offset along the sideline to the front of the building. The second method (offset-offset) holds the building parallel to the sideline but ensures that the frontage offset to the selected corner of the building matches the second offset value.

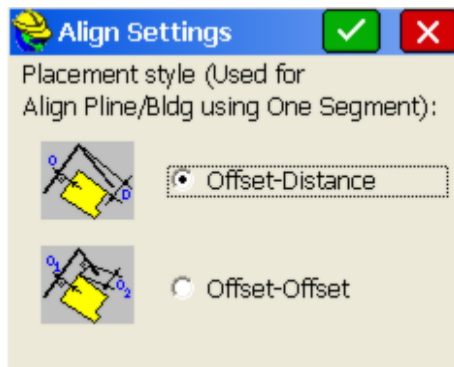

Align Pline/Building One Segment (AlignB), Offset-Distance Method:

This is a building application allowing adjustment of the building pad location in the field. If you import a map of a subdivision or building project containing a building pad, side lot lines and a frontage line, you can reset the building pad to a new, specific offset from the frontage and also force the building pad to be parallel to a selected side lot line, at a specific offset to the lot line. Refer first to the graphic below which shows an existing building on lot 84. Using the I for Inverse command in the MAP screen, you can obtain the distance from the end point of the building and then select the perpendicular snap on the lot line. The distance is 18.7 feet. Similarly, the distance from the building to the arc of the

frontage line can be computed at approximately 58 feet.

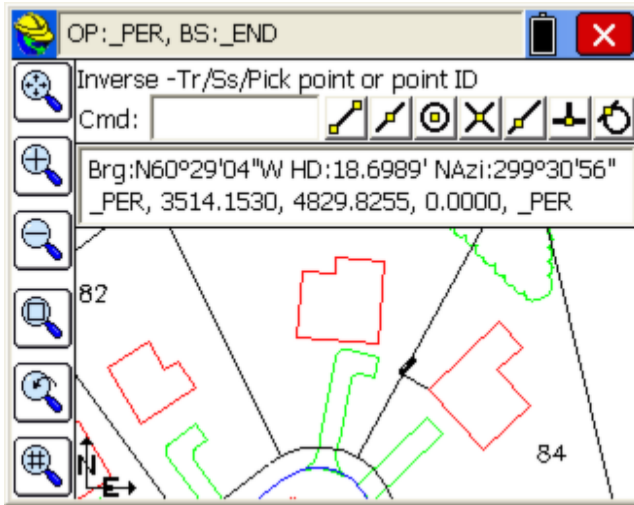

There are 2 methods of Building Align, which are set under Tools, Align Settings. The first method is to align the building parallel to a lot line at a certain offset from the frontage, measured along the lot line. This is the Offset-Distance setting for Building Align. To illustrate this method, assume the goal is to place the building parallel to the side lot line at 20 feet offset, and offset from the frontage at 65 feet as measured along the lot line. Here are the prompts for the Align Building command:

Pick Lot Segment Near Front Corner (of lot line): Pick the line shown below near where it contacts the right-of-way, near the front. The building setback offset will be calculated from the front end of the lot line.

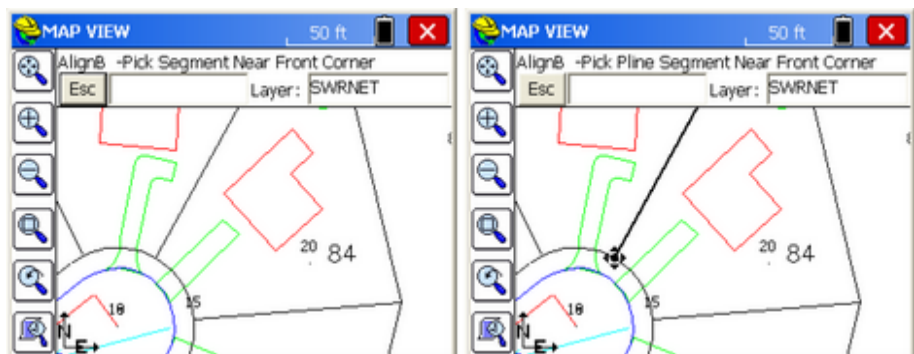

Pick Pline (Building) Segment Near Front, Lot Side: Pick the same lower left building corner as shown above, but along the side facing the adjoining lot line. This leads to the graphic below. The correct side line is highlighted.

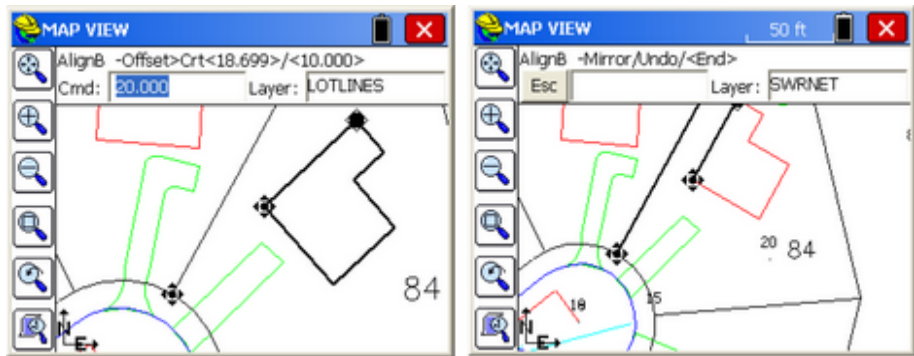

Offset>Crt<18.699>/<10.000>: Enter the desired side line offset (20).

Distance>Crd<57.919>/<10.000>: Enter the desired frontage offset (65), as measured along the selected side line. The building redraws as shown. You can Undo or enter M for Mirror, which mirrors the building around the highlighted building line (and in this case would force the building across the lot line. Even after you experiment with Mirror, you can Mirror again or Undo the entire process.

Align Pline/Building One Segment (AlignB), Offset-Offset Method: If the Align Settings under Tools is set to Offset-Offset, then two offsets will apply using the One Segment command: (1) to the side line and (2) to the front line. This method requires that the lot line be a continuous polyline for both the side and front portions of the lot, allowing just one pick, hence "One Segment" method. Also, both lines need to be straight--this option will not handle a curving front line. It is best illustrated in the simple example below:

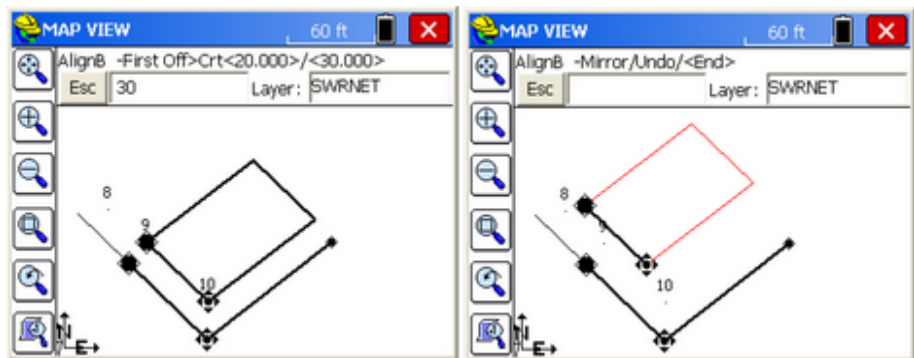

Pick Lot Segment Near Front Corner (of lot line): Do the same pick as before on the side lot line opposite the building, near the frontage portion of the lot line.

Pick Pline (Building) Segment Near Front, Lot Side: Then pick the building also on the the side facing the side lot line, between points 9 and 10 but closer to point 10. Then enter the side offset first (30 in this case) and then enter the frontage setback offset next (50 in this case). This results in the new position for

the building as shown, 50 units from the frontage line and 30 units offset from the side line, ready for stakeout. Stake out the new building by snapping to the endpoints in the command Stake Points, or follow with Offset by Segment to stake offset points.

Align Pline/Building Two Segment (AlignBC):

This option is almost identical to Align Building One Segment, Offset-Offset method covered immediately above. The only difference is that the frontage line can be a separate line, allowing for 2 picks to identify the side line first and the frontage line second. And similarly, both side line and frontage line must be straight. The command does not handle arc segments. The command differs from the Offset-Offset, One Segment method only by asking for separate picks for the side lot line (first) and the frontage lot line (second), as shown below. In fact, you can pick a continuous lot line in 2 picks, so it works with continuous or distinct, separate lot lines identically. For this reason, it is recommended just to keep the Align Building setting on Offset-Distance, and use the 2-pick approach for the double offset method.

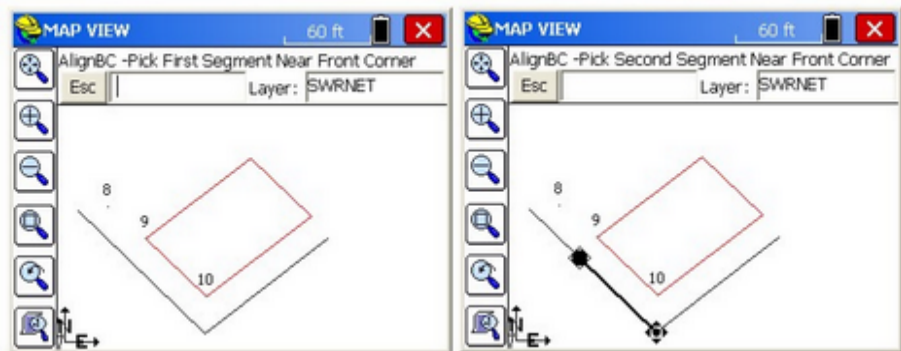

Transform (MOV, ROT, COP, SCL, MIR):

This command allows you to reposition polylines in the drawing to new locations based on your point geometry. The transformation options are **Move**, **Rotate**, **Copy**, **Scale**, **Mirror**. These work much like they do in AutoCAD, with input being the base or source point, and the destination or target point, rotation or scale. In the case of **Rotate**, the base point is the rotation pivot point and then you enter a rotation angle.

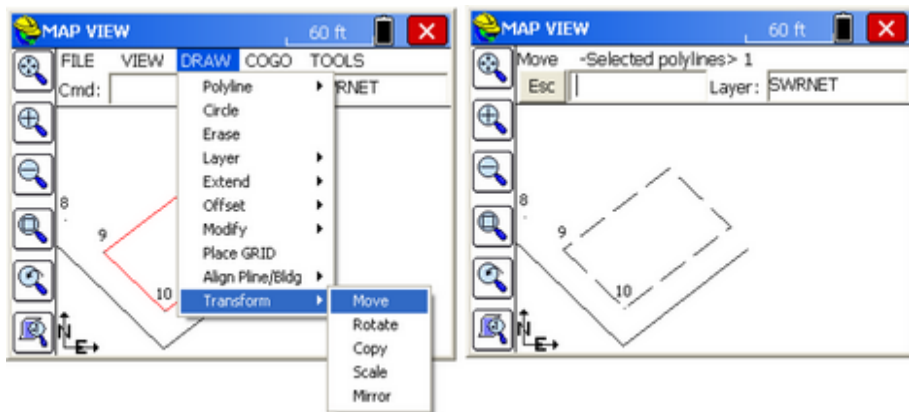

The **Move** command is shown above. One or more polylines can be selected. Then the move must be defined as the relative distance between two selected positions. If the first "Source Point" is point 10 (entered as 10) and the second "Target" position is the right corner of the selected polyline (snap to endpoint), the end result would be as shown below:

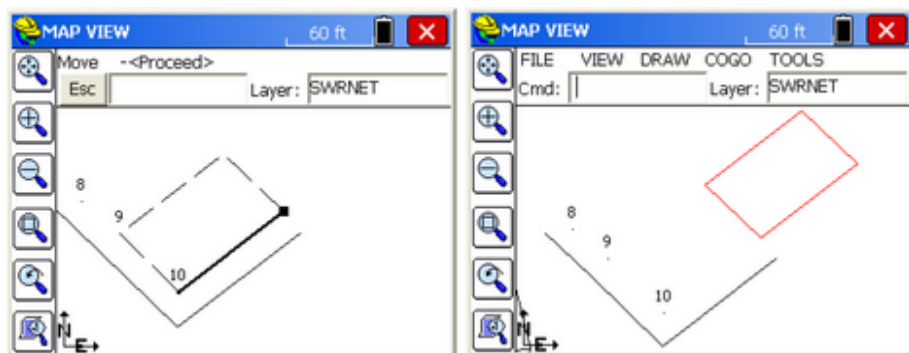

The polylines can be returned to their original position by just reversing the order of the selected Source Point and Target Point. The **Copy** command may also be used as a Move command, since it has the advantage of showing the new copy and keeping the original, in case you wish to erase the new version and repeat for better results. The **Mirror** command includes the option to delete the source or retain the source entities. **Note:** These commands only moves selected linework and do NOT reposition the corresponding points in the drawing.

The **Rotate** command has the following prompting:

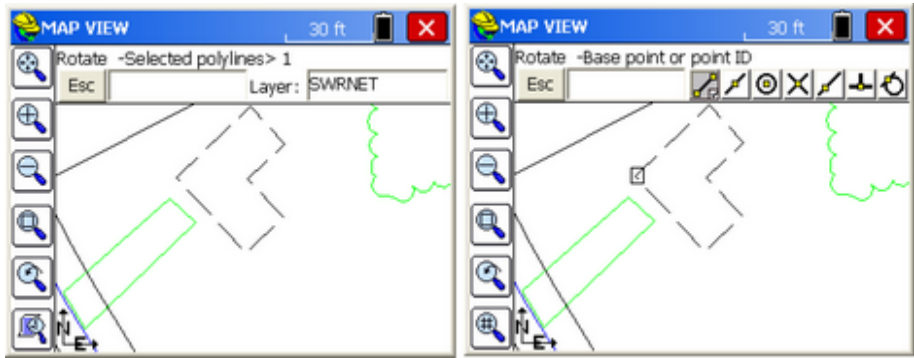

First you select the polylines to rotate. Press Enter when there are no more selections. Then choose your Base Point for rotation. Here, we use the Endpoint snap and select the corner of the building shown.

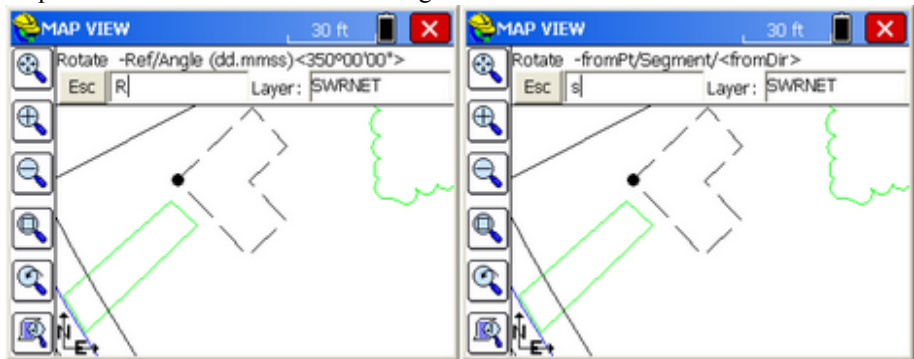

Select the pivot point first. If you want to make it parallel to an existing line, choose R then S for Segment, then pick the segment on the figure you wish to reference first. Then after that, the next pick, also by S for Segment, will be for the property line (eg. the line to the north) you wish to match.

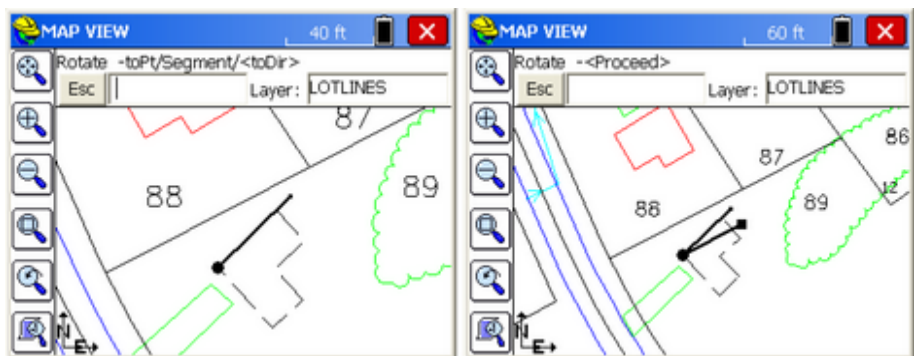

After the rotation is confirmed, you obtain the final results shown below. The simplest rotation, of course, is just by angle, where 10 degrees would rotate 10

degrees clockwise from the pivot point.

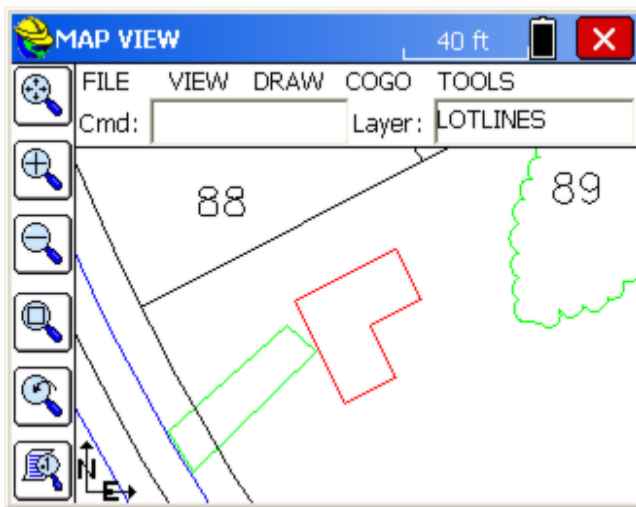

The **Scale** command operates much like the others by first requesting a base point for scaling, and then a scale factor: R for Ref is similar to rotate, where you specify the segment on the object that you are referencing and then the segment on another object you wish to match, for scaling.

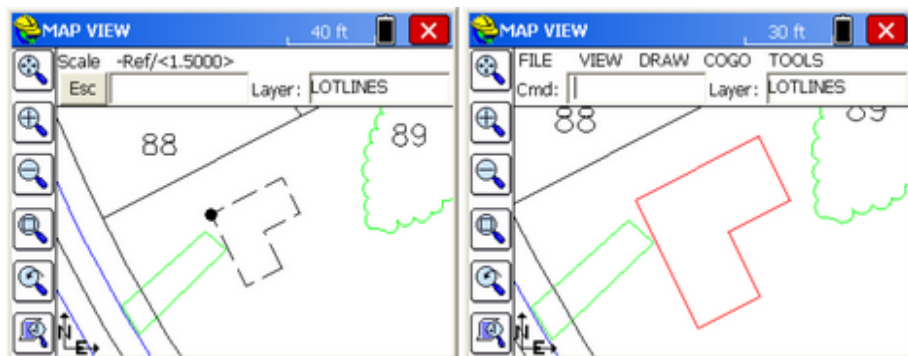

COGO

The COGO menu is found next to the Draw menu in MAP view. Below you will find each feature described.

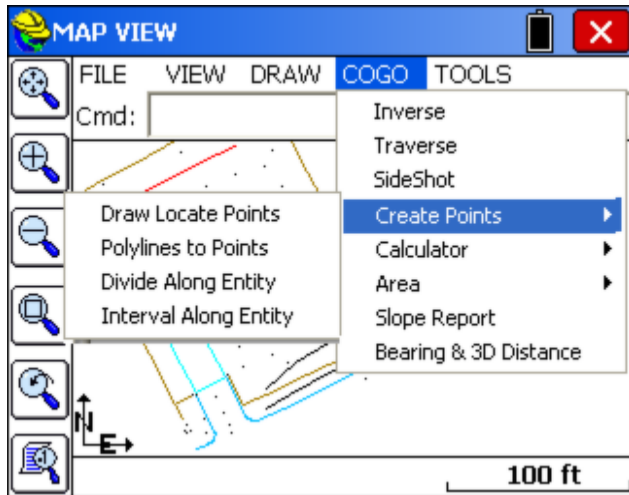

Inverse (I):

Inverse command Inverses and presents the bearing and distance between point numbers. It has the added benefit that the previous point inverted becomes the backsight, and the current point inverted becomes the occupied point, allowing you to sequence directly into the Traverse or Sideshot commands. (Use angle code 7 to turn an angle right from the backsight to the foresight.) The "snaps" are available in inverse, so you can calculate the distance from a point to a line by "snapping" to endpoint, intersect, perpendicular (as shown below) or nearest.

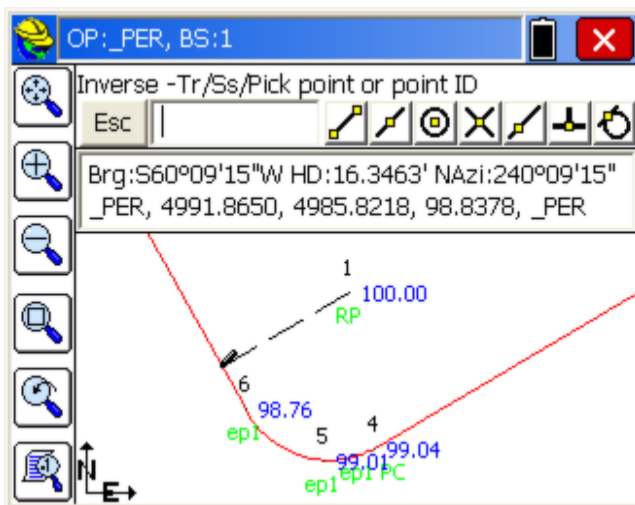

Traverse (T) (also TR):

Similar to the Sideshot command, the Traverse command will “move up” to the last point traversed, holding the previous occupied points as the backsight. Exit with Esc.

Sideshot (SS) (also S): This allows for sideshots from any point that is

“occupied” by use of the inverse command. For example, if you inverse from 126 to 150, you are “on” 150 and backsighting 126. Then at the prompt "Cmd: Inverse – Tr/Ss/Pick point or point No:", you can enter S for Sideshot. The first prompt is the Angle-Bearing Code: Sideshot-eXit/I/Tr/H/Angle-BC(1-7)<7>, which can be any of the following:

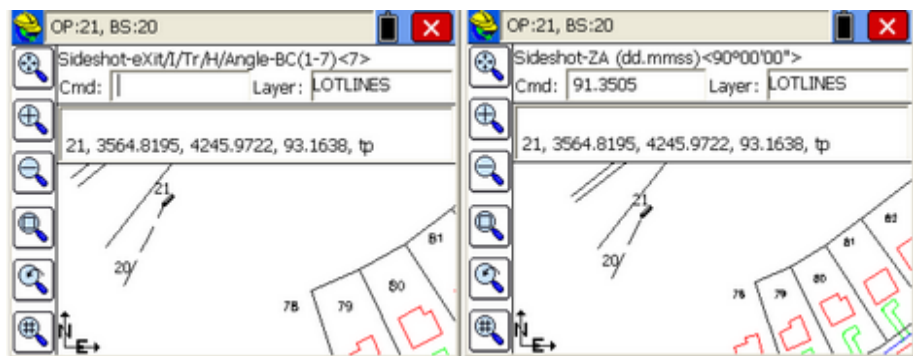
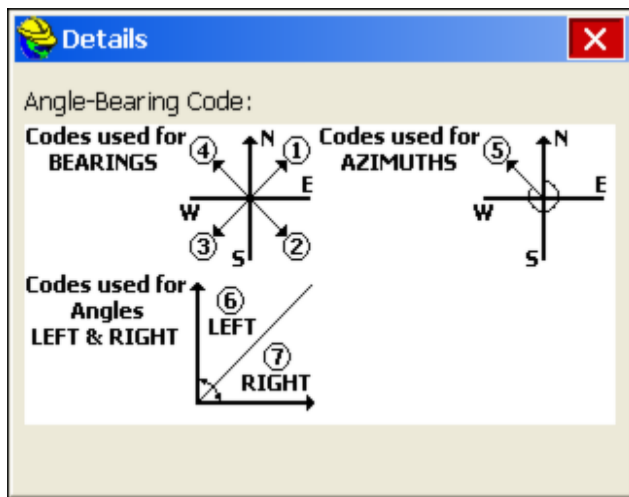

- 1-NE (0 through 90 if degrees, 0 through 100 if gons/grads)
- 2-SE (same as above)
- 3-SW (same as above)
- 4-NW (same as above)
- 5-Azimuth (360 circle if degrees, 400 circle if gons/grads)
- 6-Angle Left (degrees or gons)
- 7-Angle Right (degrees or gons)



Note that at the Angle/Bearing prompt, you can transition back to inverse (from your occupied point) or to traverse, which would move you up to the next traversed point. Code 7 turns angle right. In the standard MAP screen prior to selecting T or SS, if you click the lower left View Options button, and then select the Data tab and choose Traverse Defaults, you can turn on the Zenith Angle or Elevation Difference prompts. Then sideshot and traverse entries can be used for

hand-entry of field data. Within Sideshot, you stay on your current point, holding the backsight, and foresighting (calculating) as many points as desired. X returns to the MAP screen as does Esc.

After the angle code, the remaining prompts are the angle itself (as in 85.3522, DDD.MMSS), zenith angle, slope distance, description and point ID. Exit with Esc anytime. In gons/grads, angles are also in decimal form, and angles such as 397.9871 are valid. The lower left icon within the sideshot/traverse routine, as shown above, leads to a "Find Point" option.

Create Points - Draw Locate Points (DrawLP): This command creates points at endpoints and intersections of polylines, based on use of the "snaps". In the example below, point 23 was created at the northeast endpoint  of the building on lot 88, point 24 was created at the intersect  of the driveway and the lot frontage line and point 25 was created at the center of the arc  of the pavement line. The "snaps" from left to right are endpoint, mid-point, arc center/insertion, intersection, nearest, perpendicular and tangent.

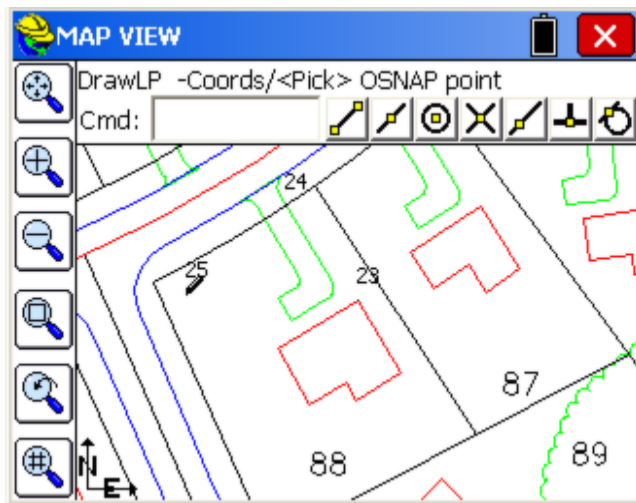

Create Points - Polyline to Points (P2P):

This command converts any selected polylines into points. It is useful in capturing points for stakeout from polylines created as offsets or brought in from DXF files. This allows you to react to circumstances in the field by creating points from polylines, when and where needed. For example, if you wanted to make point numbers out of the lot corners below on the SW lot, Select Cogo, Create Points, Polylines to Points (or more simply enter P2P at the command line). Then pick each desired polyline. The program will avoid making duplicated points on vertices that already have point IDs.

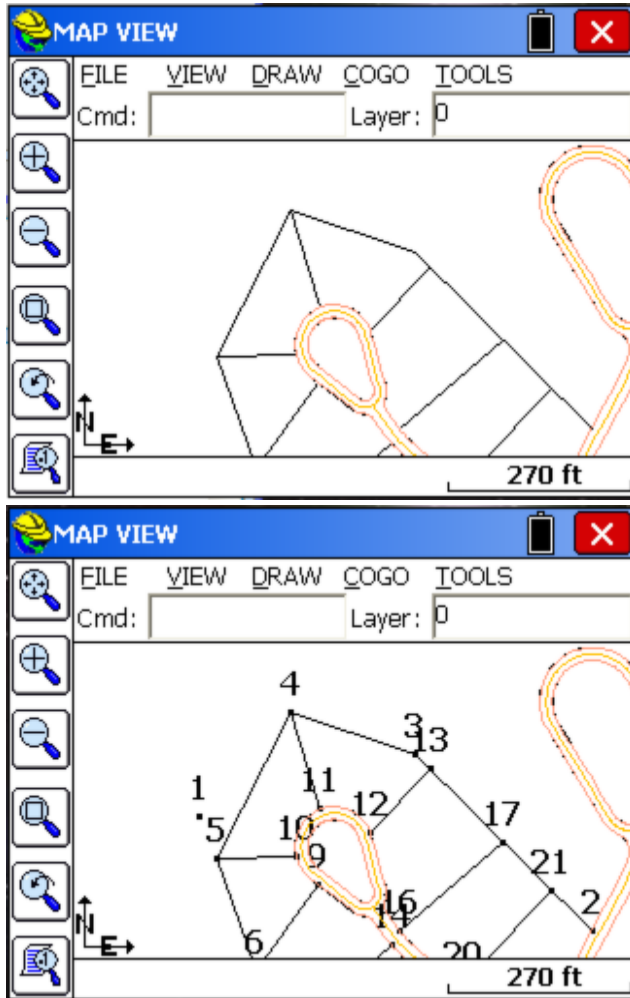

The new points are shown in “large” format, for emphasis.

Create Points - Divide Along Entity (DVS):

This divides a polyline into the number of segments entered. A dialog will allow you enter in the number of segments. There are settings to prompt for descriptions and elevations and to create points at the end points of the polyline.

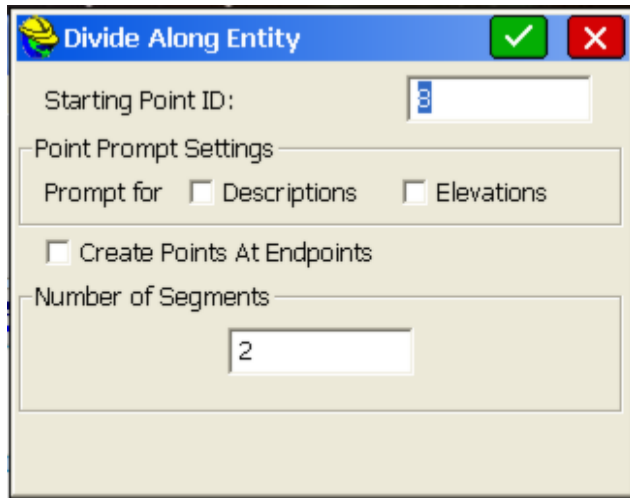

The command will create new vertices along the polyline, but can also create point numbers starting at the entered Point ID, and you can elect to be prompted for descriptions and/or elevations at each new point. If a property line were divided into two segments, you would create three new points, if Create Points at Endpoints is clicked on. Otherwise, division of a line into two segments would create only 1 new point ID, in the middle of the line or polyline.

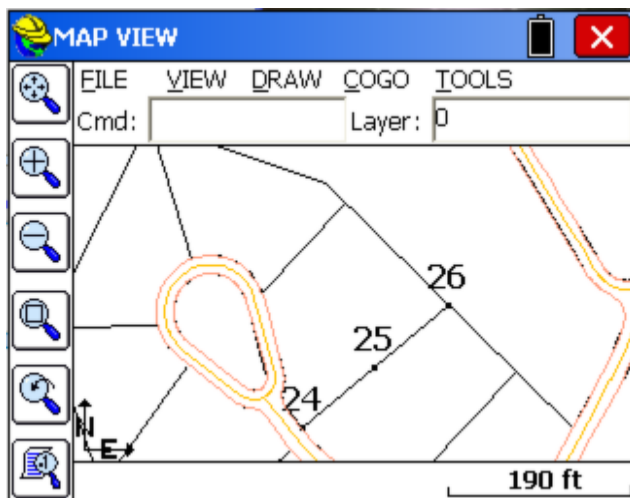

Create Points - Interval Along Entity (DVI):

This divides a polyline by the distance entered. Curves can have a different interval. There are settings to prompt for descriptions and elevations and to create points at the end points of the polyline.

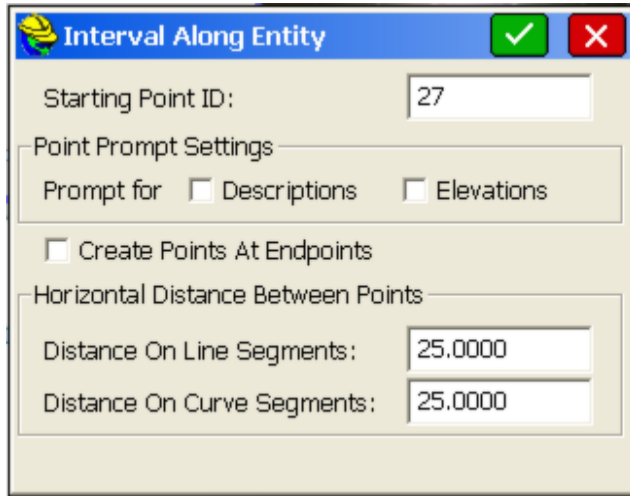

This command is often used for creating points on centerlines. Note the program resets the interval at break points like PIs and PC's. Note that you can choose to create more points at a smaller interval going around curves.

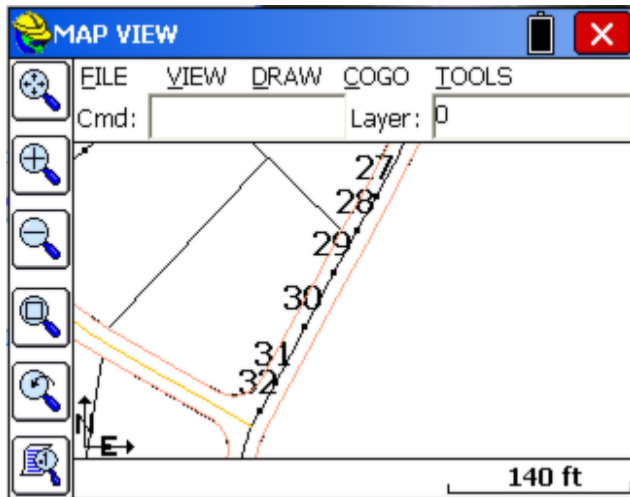

Triangle Calculator (TC):

Goes directly from the MAP view to the Triangle calculator. See COGO - Calculator for detail.

Curve Calculator (CC):

Shortcut to the curve calculator, then returns to MAP. See COGO - Calculator for detail.

Area (AR):

This will report the area of any picked polyline. If you pick an unclosed polyline, the program will draw a temporary line for the closing segment and report the

area.

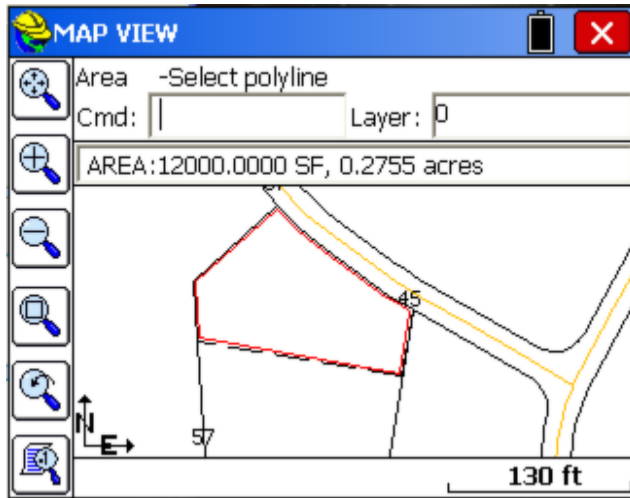

Hinged Area (HA):

This command can be used to determine the dimensions of a figure when the area is fixed and three or more sides are known. The figure must be defined by a closed polyline. After executing the command, select the polyline. Next, select the hinge point. The polyline segment clockwise from your hinge point will be the segment to move. SurvCE will then ask you if you want to keep the existing polyline. If you answer Yes, a new polyline with the desired area is created, if you answer No, the polyline you pick is modified. Next, the current area of the polyline is shown. At this point, enter the new area in the units specified under Job Settings. (If your units are set to feet, the area will be specified in square feet). See the top figure below.

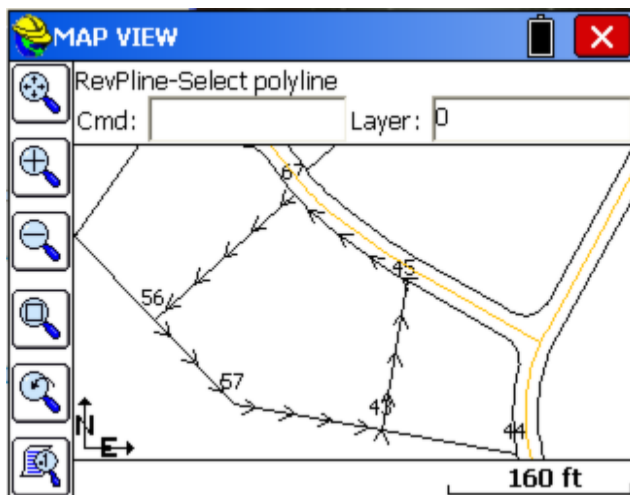

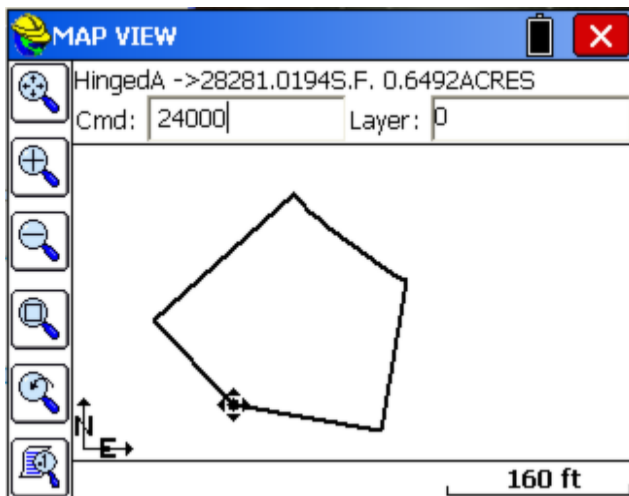
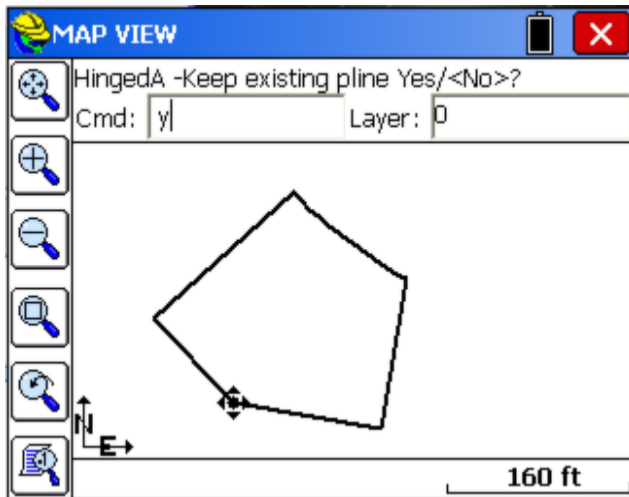

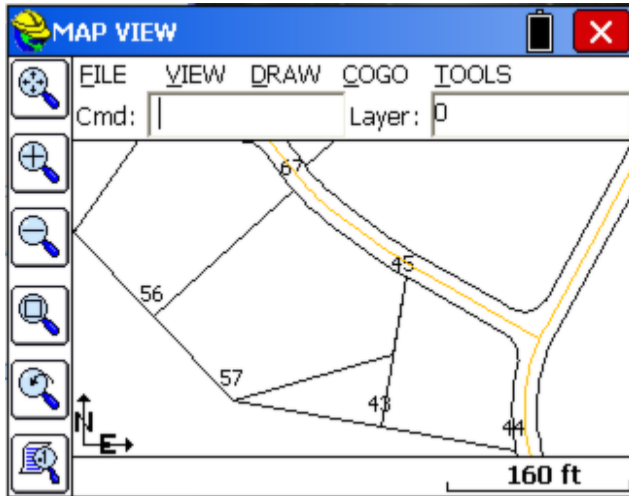

Note how the hinged side occurred on the clockwise side of the polygon perimeter (side 57 to 43). If we erase the new polyline, reverse the original polyline (RV) and repeat the command, this time answering “No” to “Keep existing” and again targeting 24000 s.f. area, we get the following:

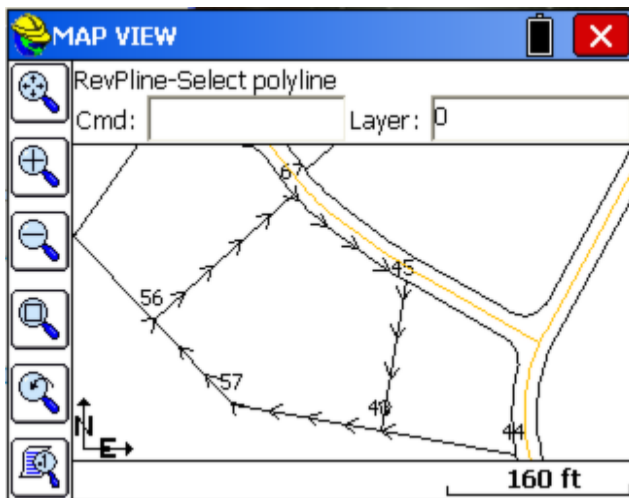

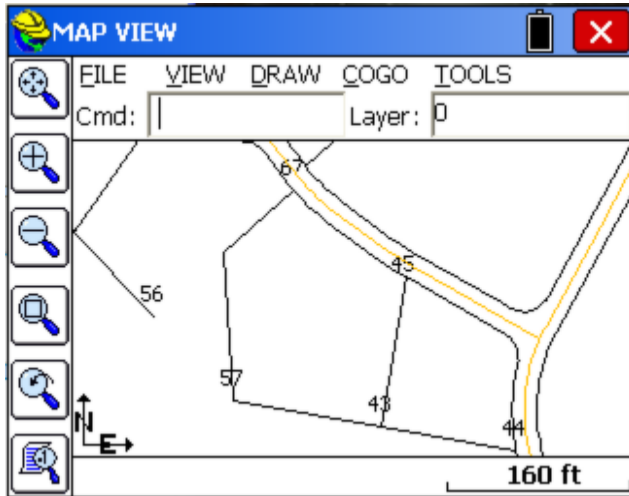

Sliding Area (SA):

This command adjusts one side of a polyline to meet a specified area. You must specify the new area in the same units as specified under Job Settings. The area to adjust must be a closed polyline. After executing the command, select the polyline. SurvCE will then ask you if you want to keep the existing polyline. If you answer Yes, a new polyline with the desired area is created, if you answer No, the polyline you pick is modified. Next, the current area of the polyline is shown. At this point, enter the new area in the units specified under Job Settings. (If your units are set to feet, the area will be specified in square feet). Let's choose to divide our new parcel into two equal areas of 12,000 square feet each.

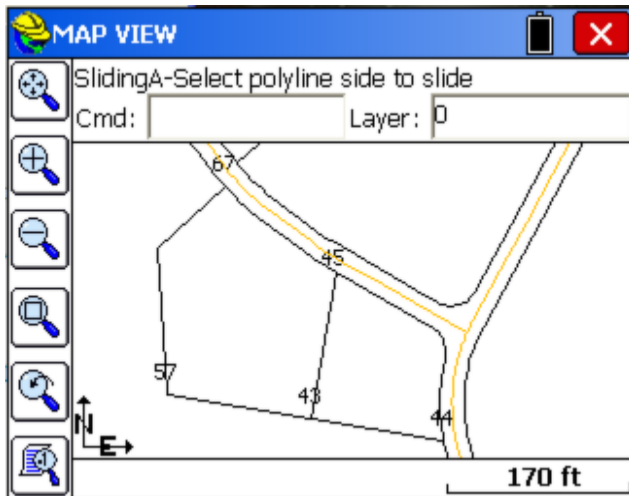

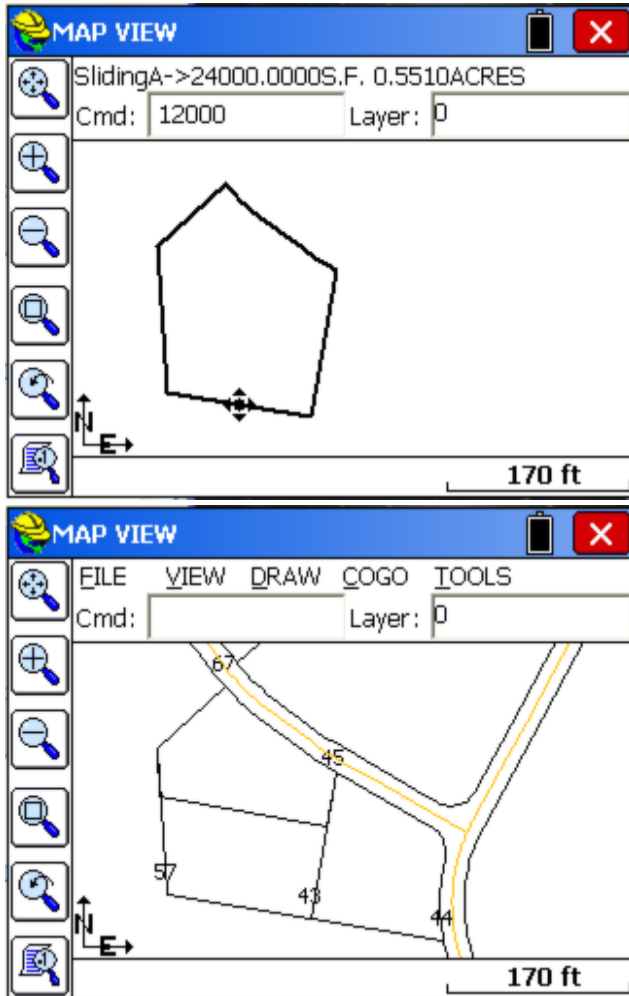

Slope Report (SR):

This command reports the horizontal area along with the slope area of a figure defined by a range of points. The command actually executes the TRIANGULATION command to compute the slopes within the defined area. There are options to include breaklines, use a predefined TIN model, and prompt for inclusion/exclusion areas. If you use a TIN model, you should click on "Prompt for Inclusion/Exclusion" and then pick perimeters where the calculation will be applied.

Consider the figure defined by points numbered 570, 97, 569, 584, 585, 75, and back to 570 as shown below. From the COGO AREA command, we see that the horizontal area of the enclosing polygon is 11,653.4122 Sq Ft. Performing the SLOPE REPORT yields the same horizontal results, but also reports the slope area, and the maximum, minimum, and average elevations and the average slope within the area.

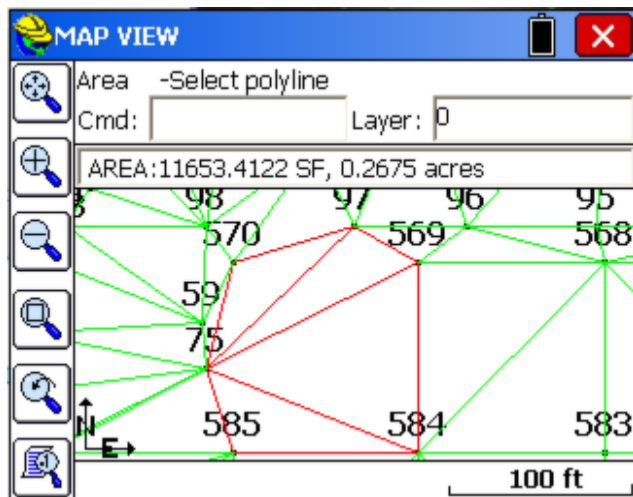

Triangulate & Contour

Points
 Range of Points:
 Wildcard descriptions:

Include: Breaklines Contours

Use Triangulation File

Prompt for inclusions/exclusions

```

Horizontal Area:
11653.4122SQ, FEET
11653.4588SQ, INT'L FEET
1294.8223SQ, YARDS
0.0004SQ, MILES
1082.6411SQ, METERS
0.2675ACRES
0.1083HECTARES
Slope Area:
16140.2722SQ, FEET
16140.3368SQ, INT'L FEET
1793.3618SQ, YARDS
0.0006SQ, MILES
1499.4854SQ, METERS
0.3705ACRES
0.1499HECTARES
AVERAGE ELEVATION: 511.4906
AVERAGE SLOPE: 62.2649
MAXIMUM ELEVATION: 520.0000
MINIMUM ELEVATION: 440.9770

```

Bearing & 3D Distance (3D):

This command reports the horizontal distance, elevation difference, slope distance, vertical angle, percent slope, slope ratio, bearing and azimuth between two 3D points. The user can pick or enter the number of two points, select a polyline segment or pick two points on any polylines from MAP using the "snaps". Within the report screen, clicking the disk icon on top will create a Txt file of the inverse for export.

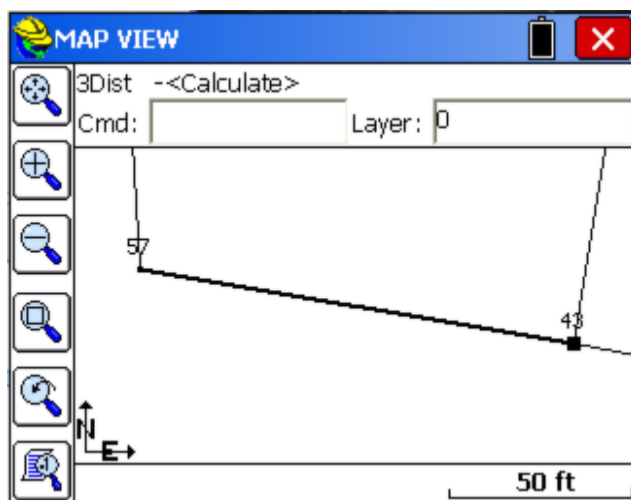

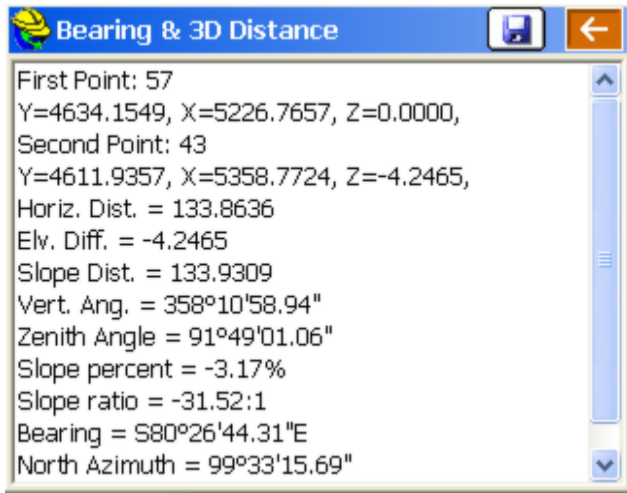

TOOLS

The Tools menu is found next to the COGO menu in MAP view. Below you will find each feature described.

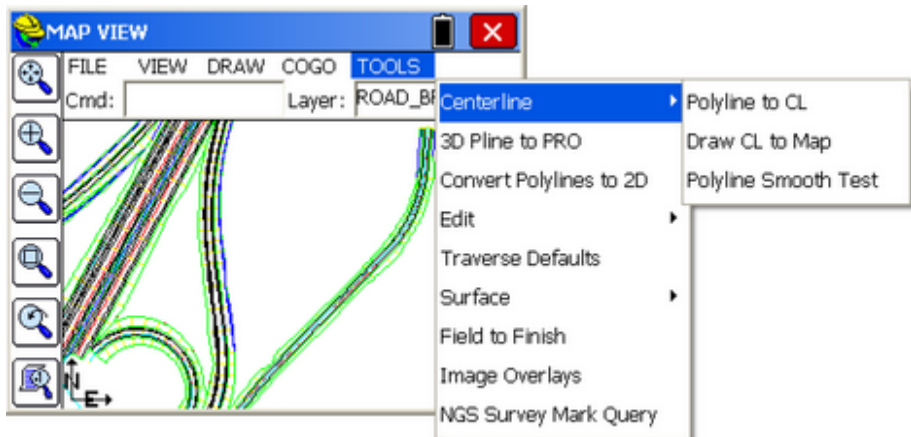

Polyline to CL (P2CL):

Converts any polyline into a centerline file for use in the Roding commands and in Centerline, Curve and Offset Stakeout. You will be prompted for starting station and the name of the centerline (horizontal alignment) file, and you will obtain a centerline report. To station the polyline in the opposite direction, use Reverse Polyline (RV), or select Draw, Modify, Reverse Polyline to change the direction of the polyline prior to issuing the command. If we choose the existing polyline as shown, we obtain the following CL file report:

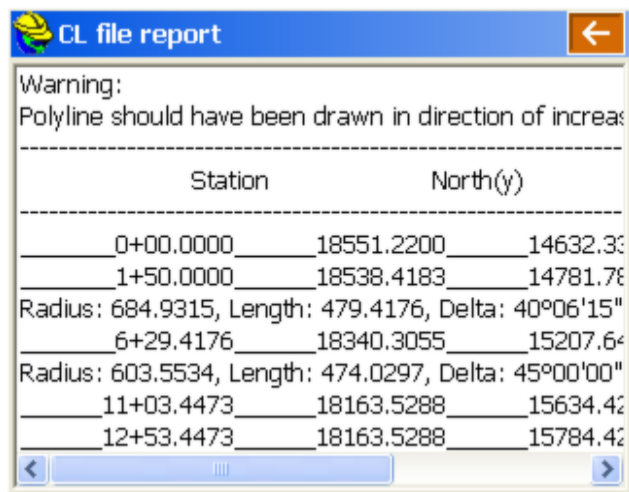
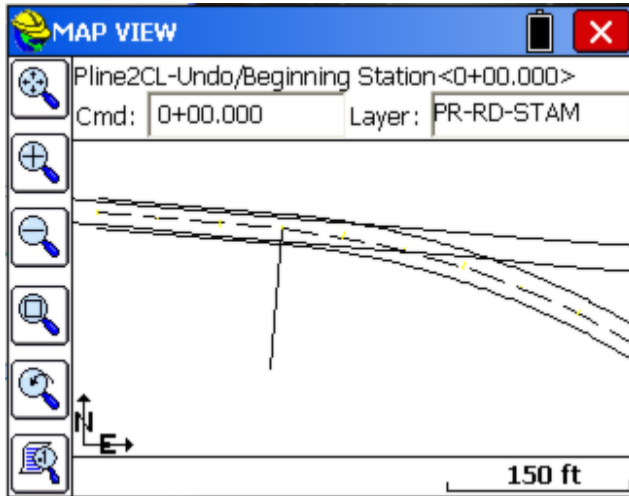

Draw CL to Map (CL2P):

This command draws a POLYLINE entity using the data from a centerline file. You can practice this command by selecting the file Demo.cl, provided with the program. It draws in the current layer set within the View pulldown, Layer command.

Polyline Smooth Test (IsSmooth):

Select a polyline to verify smoothing. A polyline with tangent curves would report "Smooth Polyline: No deflection angles greater than 0 degrees detected." A polyline such as a right-of-way line or top-of-bank line in a roadway design (see below) would report all angled points of intersections (PI's). The purpose of the command is to detect alignments that have non-tangent curves or PI points without curves. It is also useful to verify whether alignments such as right-of-ways have perfect 90 degree, right-angle deflections. The centerline with tangent curves in the graphic below, for example, reports "Smooth Polyline",

while the top-of-bank polyline (see arrow) reports the information at right.

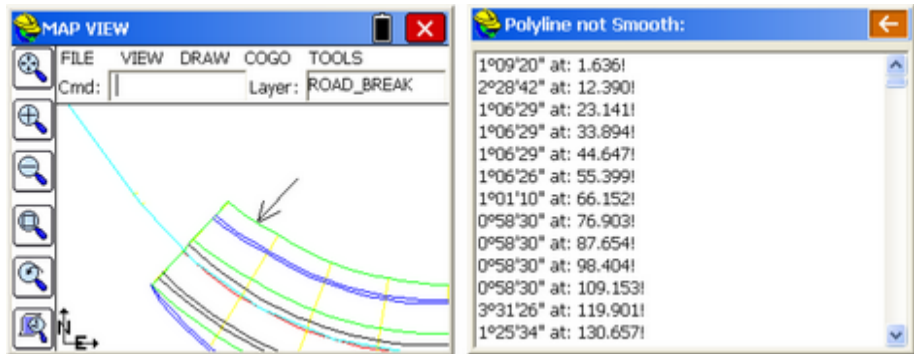

3D Pline to PRO (3DP2Pro):

Pick any 3D polyline and create a profile. If you pick a polyline at 0 elevation, the program will warn, "Cannot create PRO file. Not a 3D Pline! Please select another Polyline." If you pick a polyline that has vertices with elevations, a profile or vertical alignment file (.pro extension) will be created, and can be reviewed and edited within the Roads Menu command, option Profile Editor. You can set the starting station. Keep in mind that for alignments with curves, 3D polylines must use chords with many vertices since the program cannot present 3D polyline arcs. Because chords reduce the distance around arcs, stationing may not match the true 2D alignment. This would not impact straight alignments or deflection-type alignments such as for electric, telephone and water lines or sewer lines running between manholes.

Convert Polylines to 2D (C2D):

Pick any 3D polyline or contour polyline at uniform elevation and convert it to 2D (elevations of vertices are set to 0). Helpful when doing the Fillet command, for example, which requires a 2D polyline.

Edit - Polyline (EDP):

Remove vertices, insert vertices and update (alter) the coordinates of any vertex. For example, if we pick the centerline that was used above, we obtain the edit dialog, with options to add or remove segments or arcs, edit curve information, etc. Saving changes updates the graphics on the screen. Double-clicking any line is equivalent to tapping Update.

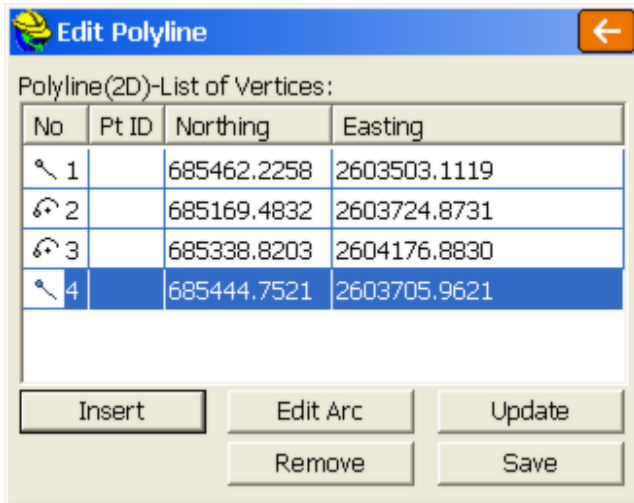

Edit - Input-Edit GIS Data (EGIS):

This command allows you to input or edit GIS attributes associated with an entity. Select the entity from the screen or for the case of a closed polyline, pick inside the area defined by that entity.

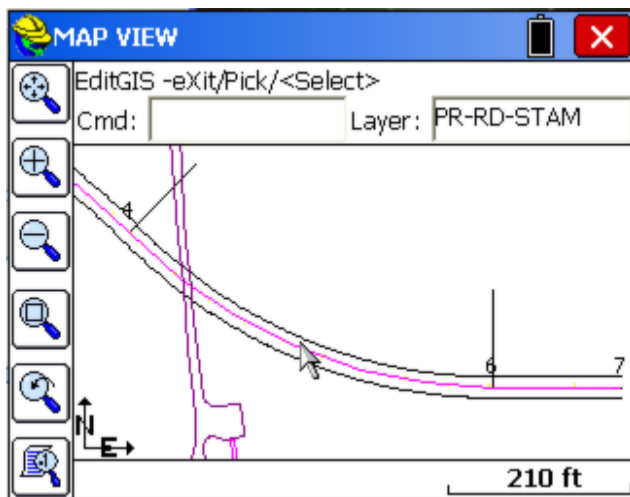

Only polylines (open or closed) can be selected. This command does not apply to attributes associated with points (use List Points to edit point attributes). Attributes are associated with points, polylines and polygons (closed polylines) either through use of feature codes or by importing shape files or dwg files exported from ESRI products. If a polyline is closed, you can use the Pick option and simply pick inside its interior. This “ROAD” description included a “SURFACE MATERIAL” attribute, which now can be edited. Drawings that are exported using "Export to CAD" from ArcMap 9.1, 10.0 or 10.1, when imported within SurvCE, will include many GIS feature options that can be selected in the top pulldown and assigned to the selected polyline, with corresponding attributes.

The "Recall" button will display the last attribute values chosen for any feature such as "BLD" (for buildings in this case) or "SW" (eg. for sidewalks). GIS attributes can be exported to ESRI using the commands Export Shape Files or Export .dwg.

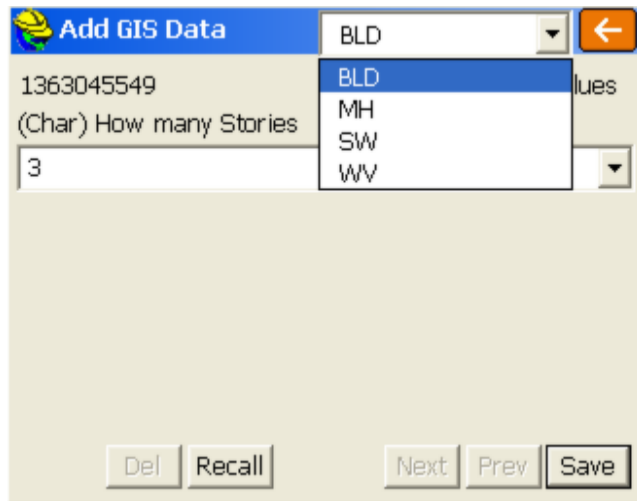

Copy GIS Data (CGIS):

Select a source entity to extract GIS data from and then apply it to a destination entity. So if one building has GIS data that applies to another building, you pick the source building and then select the destination building and it then shares the same GIS data.

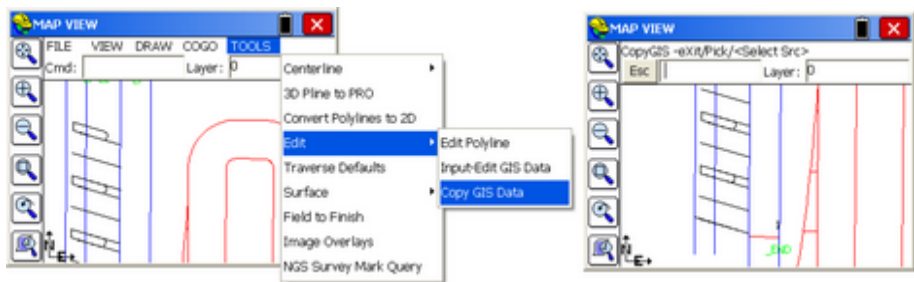

<Select Src> is the prompt to pick the source entity with existing GIS data, following by <Select Dst> which prompts to select the destination entity to apply the GIS data to. The program warns if the source entity has no GIS data. You have the option to edit the destination data, so if you copy the GIS attribute "Number of Stories" for a building, you can edit the destination data, for example, from 3 stories to 2 stories, within this copy procedure.

Traverse Defaults (TD):

This sets the elevation prompting (none, vertical, zenith, elevation difference), within the Traverse and Sideshot commands within the MAP view. Also enables a prompt for Instrument and Rod Height. Default setting is no instrument or rod heights and no vertical angle prompting, so inputs are simplified as angle/bearing

code, angle/bearing, distance, description, point number. Traverse and Sideshot entries within the MAP screen are stored to the RW5 file unless this option is clicked off at the bottom of the dialog.

Note: 3D MODE must be enabled in **Equip/Configure** for this dialog to become active. Otherwise, choices are "grayed out."

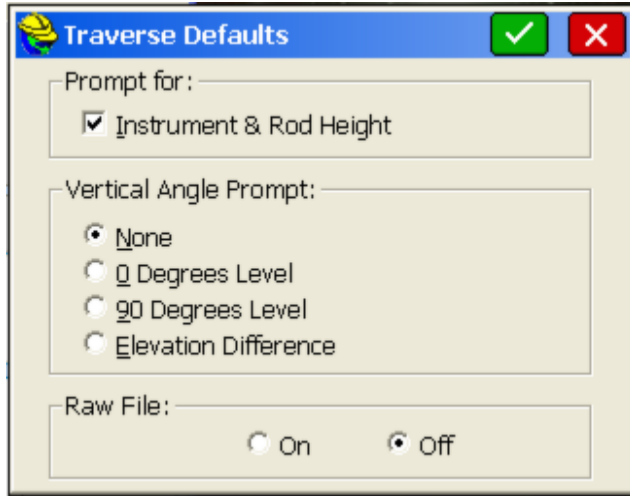

Triangulate & Contour (TRGC):

Triangulate and Contour can create a final contour map based on user given data: points, polylines. This function has many options which are specified in its dialog box. The routine will prompt also for inclusion and exclusion polylines. You can use exclusion polylines to avoid contouring within buildings, for example. If you have no exclusion polyline (or no inclusion polyline), press Enter to continue. To delete entities drawn with this command, turn off all of the drawing options and reprocess or use the View pulldown menu and isolate to the layers involved then erase all objects.

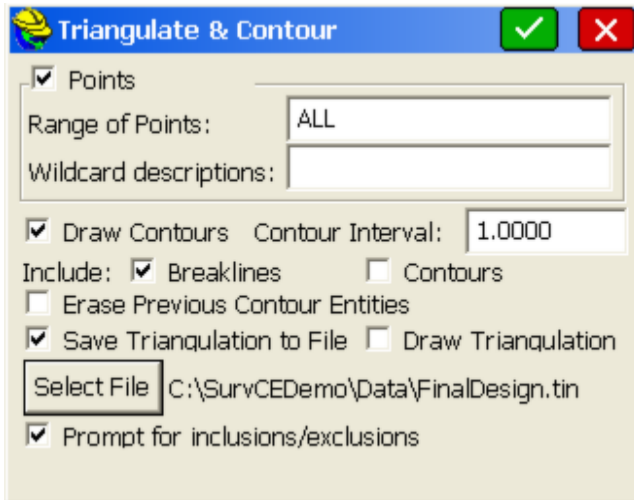

If "Prompt for inclusions/exclusions" is turned on, then the first selection is for the inclusion and optional exclusion polylines. If a ".tin" is saved, it can be recalled in commands such as Elevation Difference and used for stakeout and determination of cut and fill. If "Draw Triangulation" is turned on, the triangulation lines will be drawn. When selecting entities for contouring and triangulation, there are 3 types of entities that can be selected: Points, Breaklines and Contours. Points would be point IDs, breaklines would be 3D polylines and contours would be 2D polylines at non-zero elevation.

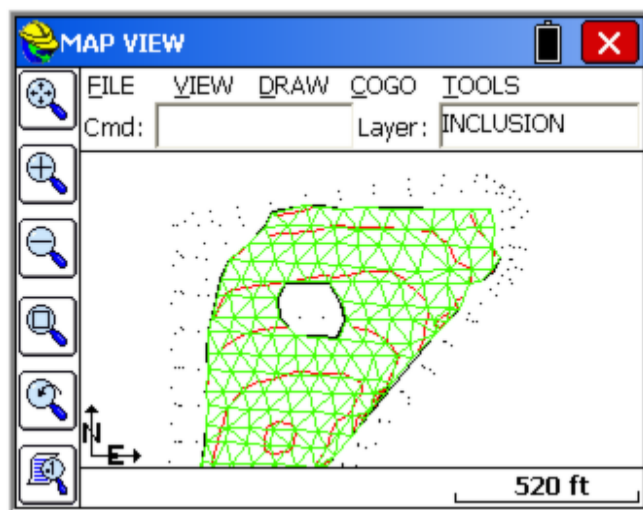

Volume (VOL):

Volumes can be computed by several methods, using surface files (eg. ".tin" files), point ranges and/or layers to define existing and final surfaces. Perimeters can be used to further limit the area of the volume calculation.

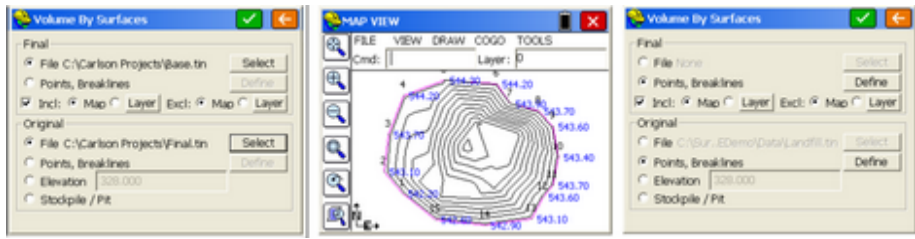

In the example above left, two tin files are used to define the surfaces for volume calculation, as enclosed by an inclusion perimeter. In the example above middle, the base surface might be defined by points 1 to 15 and the final surface defined by the contour and perimeter layers. Referring to the graphic below, which illustrates the same stockpile as above, the "Final" point range could be defined as ALL points, and the "Original" point range could be defined as the base points of the stockpile or points 1-15. Use the "Define" button to specify the desired layers and point ranges to include in the calculation for original and final surfaces.

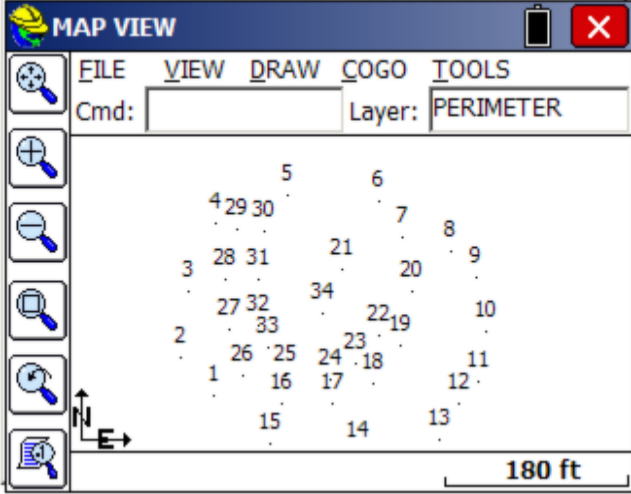

So using the settings above in the Volume routine, you would verify your two point ranges, then click OK. For example, the "Original" surface point range would be set as follows using the "Define" button for "Original" prior to clicking OK.

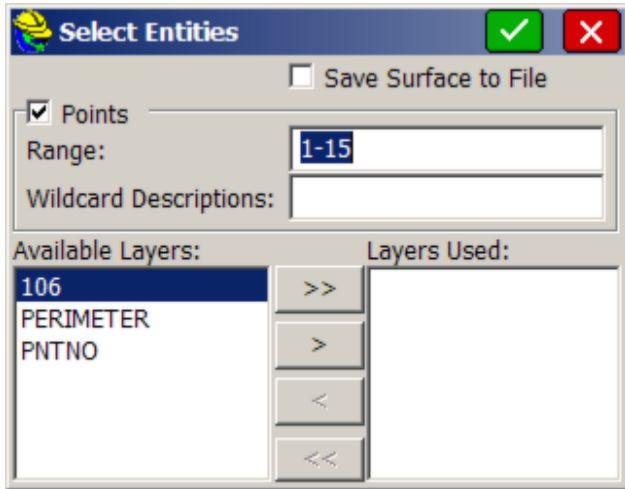

Clicking OK moves forward to a shrink and swell factor screen. Only if you are set to English units do you get the option for tons based on a density factor. In metric units, the volume is presented in cubic meters. You can create a new surface TIN file that merges the original surface with the final surface within the selected or assumed perimeter. If you do not have an inclusion perimeter, then the largest "convex" figure defined by all final surface points and entities becomes the default perimeter.

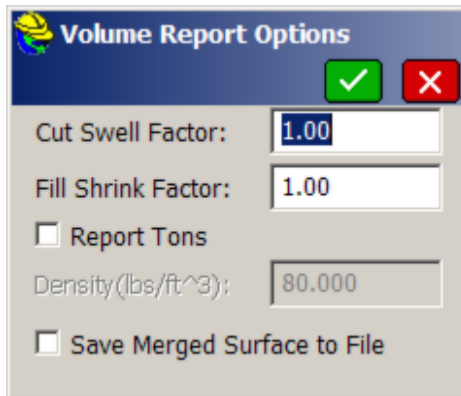

Clicking OK continues on to the Volume Report.

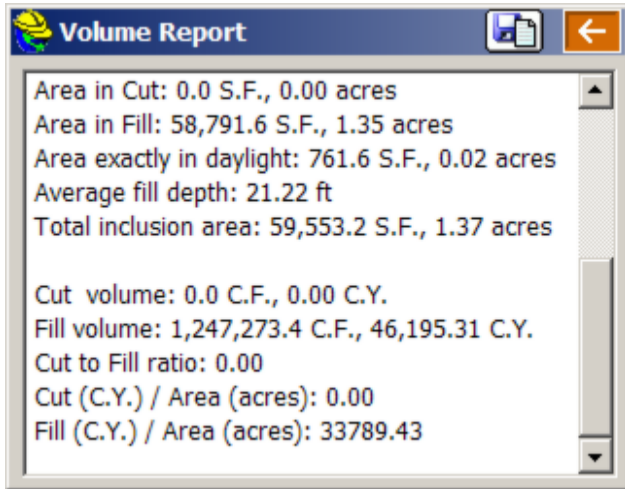

The report can be saved to a text file using the “Save to Disk” icon at the top of the screen within “Volume Report”. Click the “Return” arrow to continue back to the Map screen. If you draw a 3D polyline perimeter connecting points with elevation representing the outer limits of the volume calculation (using Draw, Polyline, 3D), then you can click on Inclusion and use the polyline as an inclusion perimeter. You can also use drawn elements on different layers as part of the volume calculation, if they are 3D, by moving them over to the right-column using the “Define” button. Volumes can also be conducted between “File” surfaces, TIN files made with Triangulate & Contour or within the Volume command itself using the option “Save Merged Surface to File.”

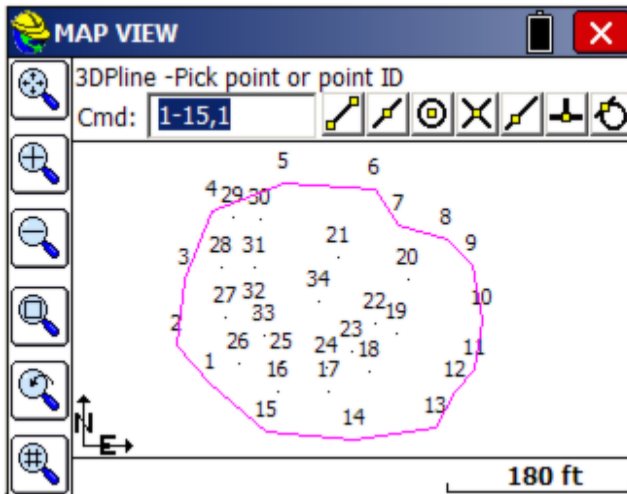

Finally, if you are doing a stockpile and make the effort to put this outer perimeter in the “Perimeter” layer, then you can select the “Stockpile” option within Volume, define the final surface appropriately, and click OK. You don’t need any other definition for the original surface. This is because the Perimeter layer will

define both the inclusion perimeter and the original surface in this case.

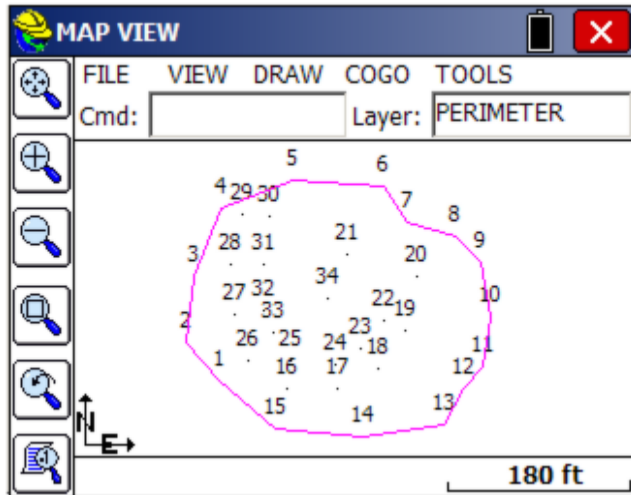

List Elevation (LELV):

This command allows the user to pick on an entity and retrieve the elevation of that point. If you pick on a 3D polyline, you will get an interpolated elevation at the picked point.

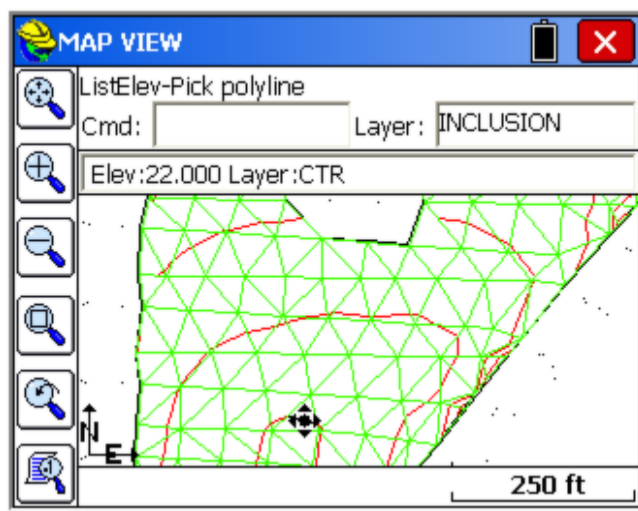

Field to Finish (F2F):

This command will redraw the linework created with Feature Codes based on the current coordinates of the points. So if a GPS file was “processed” using a new localization, or a total station survey was adjusted, the existing linework made by use of Feature Codes will erase and redraw by connecting to the adjusted coordinates. In this way, polylines on the MAP screen created by field surveying will be redrawn to recapture their association with the adjusted point coordinates.

Note that linework created by Feature Codes will redraw automatically in all graphic screens after coordinate positions or descriptions are edited within File-Points. The F2F command will restore linework to point-based positions after erasing or moving linework on the screen.

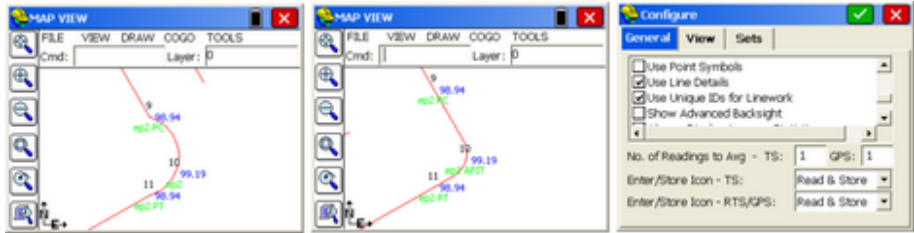

In the example above, a field survey of a curve through points 9, 10 and 11 created a bulging curve due to mis-measurement of the true PC of the 3-point arc. If point 10 is clicked and edited with the field code EP2 AFIT, the AFIT (or as user-defined in the Special Codes within Feature Codes) on the middle curve point will force a tangent arc and adjust the true PC and PT points, keeping the field-measured points on the tangent. Then if Field-to-Finish is selected within the Tools menu, the curve will redraw. Note also that within Equip, Configure, if "Use Line Details" is clicked on, this setting has the effect of automatically re-drawing the linework upon any edits, without selection of Tools, Field to Finish.

When using Field to Finish, any line that is not ended with an "end" or "close" code will be detected and presented. These are very common when using the "counter" or appended number method of coding. This refers to coding a first EP as EP1, EP1, EP1, and a second EP as EP2, EP2, EP2. In this case, no end code is used--the suffix on the EP indicates which line is being coded and drawn. When these types of codes are selected (versus EP, EP, EP End or EP ST, EP, EP) then you may be prompted as shown below. Typically, choose the option "End All". This same screen is obtained by choosing the option "V" for Review (versus Redraw) when first selecting the command. Update and Redraw accomplish the same thing

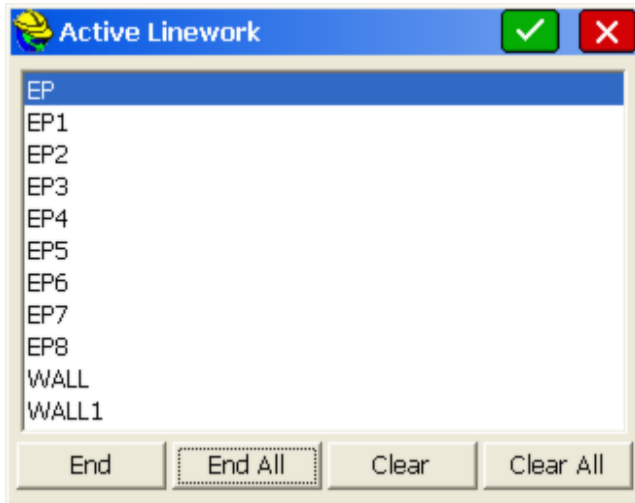
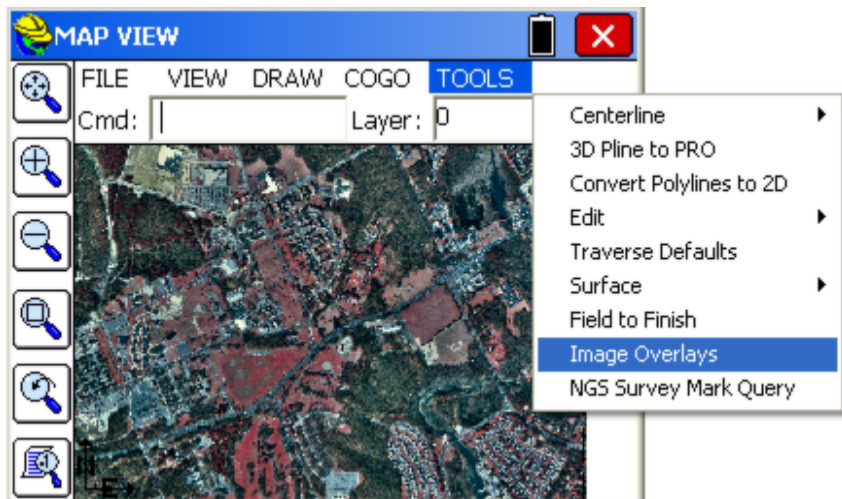

Image Overlay:

This command will attach an image database to the SurvCE drawing. Image databases are georeferenced aerial photography or image maps. These image databases can contain multiple large images that have been processed for quick display in SurvCE. The boundary for the image-set is shown by a dashed line. Images are inserted in coordinate system and units of the image. Image databases are processed with the Image X-Port utility of Carlson X-Port and take the form of IMD or IDB files. Only using SurvPC, can images be directly imported as jpg, tif and other forms. The option to Save Image Boundary Points creates points at the 4 corners of the image, allowing you to zoom to those points. However, Zoom Extents (upper left icon in MAP screen) will zoom to the extents of the image if no points exist in the file.





Images that do not have any georeference information built into them (or available in a separate jpw or tfw file) must be calibrated within Carlson X-Port, the office software companion to SurvCE, using the Image Manager.

	<p>Geo-Calibrate the Google Image</p> <ul style="list-style-type: none"> • Collect at least two points that can be located on a Google Image. • Export points to KML. • Import the KML file into Google Earth. • Save the Image with Google Earth. File Save /Save Image. • Using Carlson Image Manager create a world file with Tool,Geo-Reference by User Points. • Process the Image with Image Set Manager.
--	--

NGS Survey Mark Query: This command will search the published NGS database for all recorded monuments or control points stored on the NGS website, within a specified radius of the current position. It requires an internet connection by cell phone or wireless.

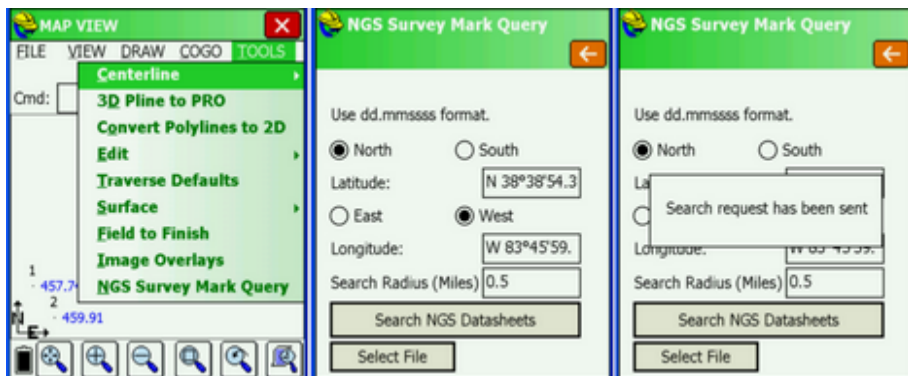

The default Search Radius is the area shown within the current Map Screen view. The latitude and longitude are calculated from the map coordinates and current projection.

Since this is a NGS (US only feature) the search radius is in decimal miles. Search NGS Datasheets will get all the datasheets for this search radius. You can expand the Search Radius further as desired. The program sends a request to the NGS web site. Please be patient while the data is being recalled--it may take several seconds. This will download a new search copy it to a folder NGS_Control_jobname. The default name for the file is gis.xml. The information in these folders can be recalled (without internet connection) using Select File.

The points will appear in a list, as shown below, whether based on a fresh search or if recalled using Select File.

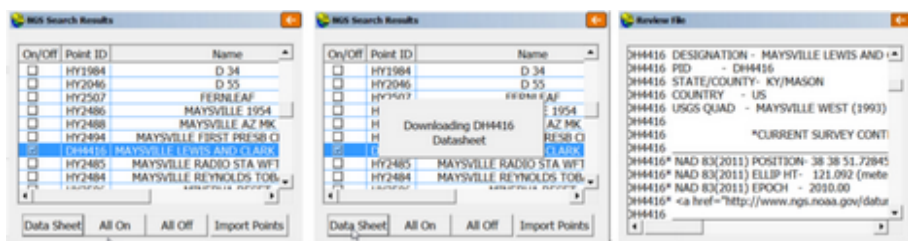

By default, all the recalled monuments are unselected (Off). You can select individually or Select All. If you highlight a point, you can study its full information by clicking Data Sheet. The button Map Points stores all selected points to the coordinate file, and they will display on the screen. If combined with an Image Overlay, points can be easily located for reference, usable as GPS control points or as control for total station measurement.

Tutorials

This chapter contains five tutorials designed to assist you in learning Carlson SurvCE.

Tutorial 1: Calculating a Traverse (By Hand) with SurvCE

To do a hand traverse with SurvCE, go to the MAP screen. To get there, click the icon in the upper right corner of your screen labeled MAP. Once there, you will set your defaults for traversing.

Tutorial 2: Performing Math Functions in SurvCE Input Boxes

Various input boxes in SurvCE allow the user to calculate math functions "on-the-fly". The basic steps for getting started are shown here.

Tutorial 3: Performing a Compass Rule Adjustment

This tutorial shows a compass rule adjustment, with various SurvCE screen captures to guide you.

Tutorial 4: Defining Field Codes, Line/Layer Properties & GIS Prompting

This tutorial will assist users in defining Field Codes in SurvCE. SurvCE can have one pre-defined FCL (Feature Code List) file loaded with the job coordinate CRD file. The Feature Code List file stores pre-defined field codes that define Line/Layer drawing properties and, optionally, GIS prompting. More than one FCL file can exist, but only one can be loaded at a time per job coordinate CRD file. The operator builds this FCL file using option 5 "Feature Code List" in the File main menu.

Tutorial 5: Standard Procedures for Conducting GPS Localizations

This tutorial is intended to assist users with the recommended localization method for SurvCE. Other methods can be used, and it is up to the individual users to determine which is best for them.

Tutorial 1: Calculating a Traverse (By Hand) with SurvCE

In order to do a hand traverse with SurvCE, go to the **MAP** screen by clicking the icon in the upper right corner labeled MAP. While in the map screen, select the **Map Settings** icon to set your Traverse Defaults



Traverse Steps:

- 1 To begin, you must key in the command for inverse by typing "I". This will establish your occupied and backsight points. The command prompt will display the following:

Cmd:Inverse - Tr/Ss/Pick point or point No

- 2 Key in the backsight point number followed by the [ENTER] key.
- 3 Key in the occupied point number followed by the [ENTER] key.
- 4 Key “T” for Traverse or “S” for Sideshot followed by the [ENTER] key.
- 5 If you keyed in “T” for traverse, the command prompt will be waiting for an angle code by displaying the following:

Cmd:Traverse - eXit/I/Ss/Angle-BC(1-7)<7>

If you keyed in “S” for sideshot, the command prompt will also be waiting for an angle code by displaying the following:

Cmd:Sideshot - eXit/I/Tr/Angle-BC(1-7)<7>

The code choices you can key in are as follows:

- 1 - Northeast Bearing
 - 2 - Southeast Bearing
 - 3 - Southwest Bearing
 - 4 - Northwest Bearing
 - 5 - Azimuth
 - 6 - Angle Left
 - 7 - Angle Right
- 6 Key in the angle code of choice followed by the [ENTER] key
 - 7 Key in the angular value in the dd.mmss format followed by the [ENTER] key.
 - 8 If you selected a vertical prompt under **Traverse Defaults**, then key in the appropriate value followed by the [ENTER] key.
 - 9 Key in the slope distance followed by the [ENTER] key.
 - 10 Key in the point description followed by the [ENTER] key.
 - 11 Press the [ENTER] key to accept the next available point number or key in a new point number followed by the [ENTER] key.
 - 12 If you traversed, then you are now occupying the new point and are backsighting the previous point of occupation. If you sideshot the new point, then you are still at the previous setup and ready to compute the next point.
 - 13 Options at the command prompt when presented with the messages listed in step 5 are as follows:
 - X - Exit
 - I - Inverse
 - S - Sideshot
 - T - Traverse

Note: in order to establish new occupied and backsight point information, you must use the “I” (Inverse) command and define the backsight point first and the occupied point second.

Tutorial 2: Performing Math Functions in Carlson SurvCE Input Boxes

Many input boxes in SurvCE allow the user to calculate math functions "on-the-fly".

To enter rod heights while in a GPS setup screen that is not in your current units (e.g. you're using a 2 meter pole but working in U.S. feet), key in the following:

The Rod Height followed by “m” for Meters, “ft” for Feet and “ift” for International Feet followed by the [ENTER] key will convert the measurement into your current units (e.g. 2m = 6.5617).

To compute the azimuth from one point to another to automatically enter in the azimuth while using the **Point by Direction** option in **Point Store**, key in the following:

Point ID,Point ID (e.g. "1,2")

To add or subtract a value from the computed azimuth, key in the following:

Point ID,PointID+Angle (e.g. "1,2+90")

Or

Point ID,Point ID-Angle (e.g. "1,2-90")

Tutorial 3: Performing a Compass Rule Adjustment

In the example below, as shown in the next figure, the traverse was performed by occupying point 1 located at the NW corner of the block. The initial backsight was established by azimuth, measured and stored as point 2 shown NW along the hanging leg. Angles and distances were measured in a clockwise direction. Point numbers 6 and 1 are at the same location and point numbers 7 and 2 are at the same location. This method allows for the closing of the angles and the measurement of all traverse legs.

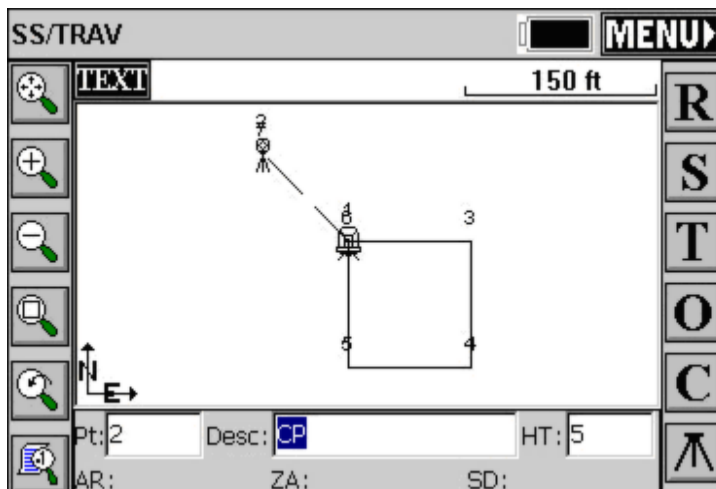

Process Raw File

Select “Process Raw File” from the “COGO” tab, as shown below in this figure.

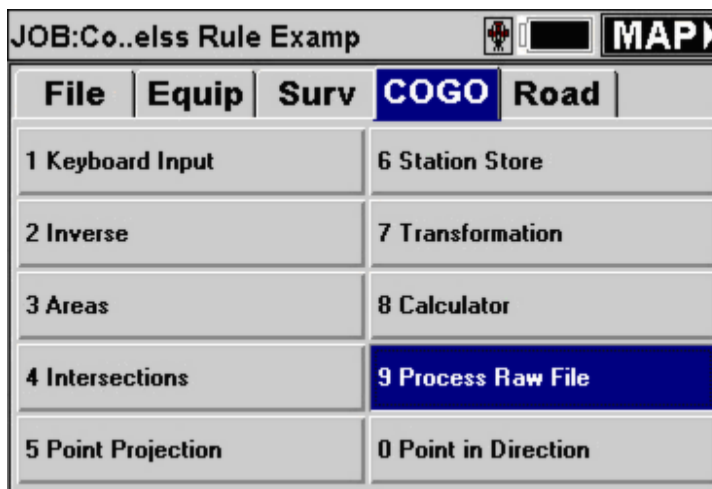

Select Raw File

The next figure below shows the standard Windows file selection dialog. Select the RW5 file you want to process followed by the “OK” button.

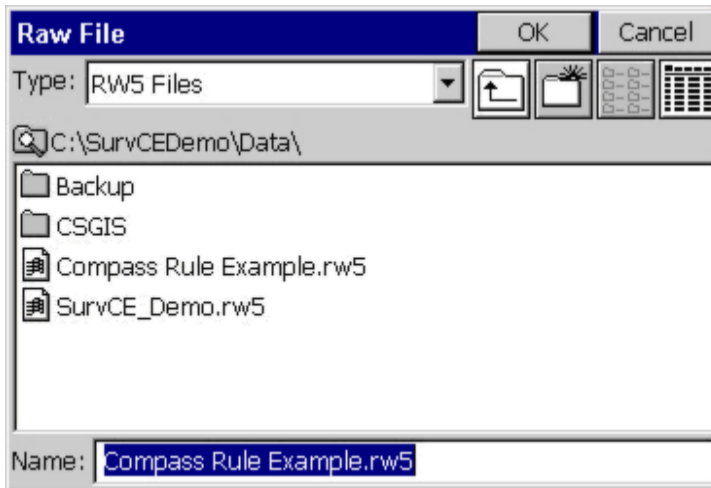

Select “Compass” from the adjustment options dialog box as shown in this figure below.

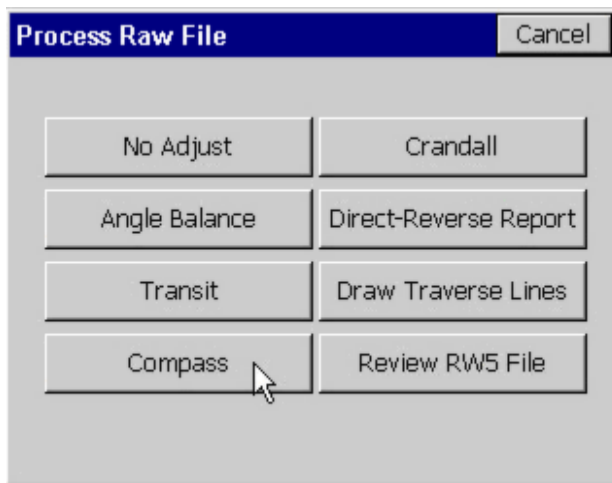

Reference Closing Point

Key in the initial occupied point number for the “Reference Closing Point #:” and toggle on the “Apply Angle Balance” option, followed by the “OK” button, as shown in the next figure below.

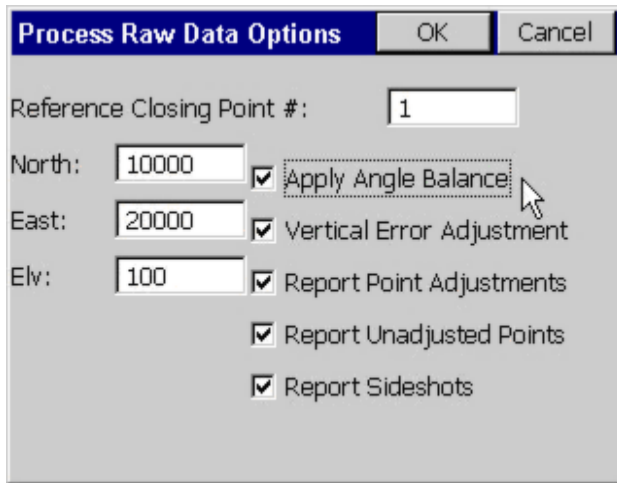

Closed Traverse

In a closed traverse scenario, the reference closing point will always be your initial occupied point name.

Note that you will need two known points, or one point and a known azimuth, for a closed traverse. The angle balance point will be the same location as the original backsight and will not be adjusted.

Open Traverse

In an open traverse scenario, the reference closing point will be a stored point name or coordinates that represents the known values for the last occupied point in the traverse.

Note that you will need two known points, or one point and a known azimuth, at the beginning and at the end of an open traverse; one point at the end will be used to close on and other will be used for angle balance (when Angle Balance is applied). The angle balance point will be the same as the last foresight point in the traverse and will not be adjusted.

Traverse Points

You'll notice in the Angle Balance Measurement figure below, since you keyed in the data yourself, that the number of traverse points in this survey is 7. Since point 7 was only measured to avoid and record the closing angle balance measurement by hand, in this example the traverse is only from points 1 through 6. Replace the 7 in the "Ending Point Number" input box with a 6, as shown in this next figure immediately below, followed by the "OK" button.

Note that point 6 should be the same location as point number 1 in a closed traverse.

Traverse Points OK Cancel

Starting Point Number : 1

Ending Point Number : 6

Angle Balance

Select the foresight shot from the last occupied point to the original backsight location. In this example we would select the leg measured from point 6 to point 7, since point 7 was our foresight angle balance shot to point 2. Press the “OK” button. In an open traverse, this would be the measured leg that represents the known azimuth or bearing at the end of the traverse.

Angle Balance Measurement OK Cancel

Select the Angle Balance Shot:

Occupy Pt	Foresight Pt
1	2
1	3
3	4
4	5
5	6
6	7

Reference Closing Angle

Finally we need to provide the reference closing angle (record). This is the original backsight azimuth. Key in point 1 and point 2, or key in the known azimuth or bearing, followed by the “OK” button.

In an open traverse, key in the stored point numbers that represent the values for the known control points at the end of the traverse, or key in the known azimuth or bearing.

The adjustment report should be presented, and the adjustment should be complete. The angle balance point number 7 will not be adjusted to fit point number 2, and can be discarded.

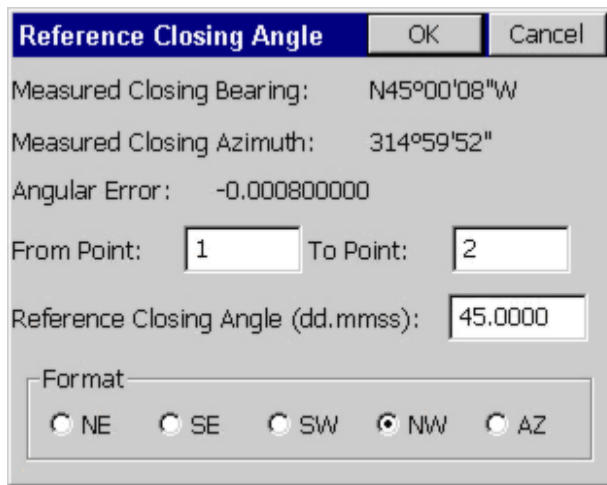

The image shows a dialog box titled "Reference Closing Angle" with "OK" and "Cancel" buttons. It displays the following information:

- Measured Closing Bearing: N45°00'08"W
- Measured Closing Azimuth: 314°59'52"
- Angular Error: -0.000800000
- From Point: 1 To Point: 2
- Reference Closing Angle (dd.mmss): 45.0000
- Format: NE SE SW NW AZ

Tutorial 4: Defining Field Codes, Line/Layer Properties & GIS Prompting

SurvCE can have one pre-defined FCL (Feature Code List) file loaded with the job coordinate CRD file.

The Feature Code List file stores pre-defined field codes that define Line/Layer drawing properties and optionally GIS prompting. (More than one FCL file can exist but only one can be loaded at a time per job coordinate CRD file.)

The operator builds this FCL file using option 5 "Feature Code List" in the File main menu. See the figure below.

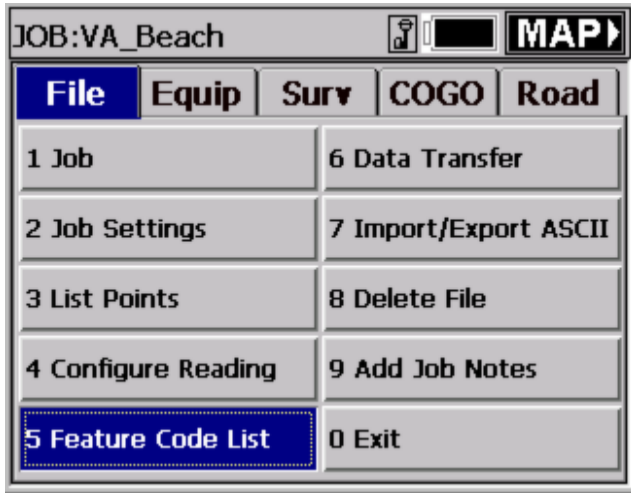

After you select 5 Feature Code List, the following Code List pop-up box is displayed. See the figure below.

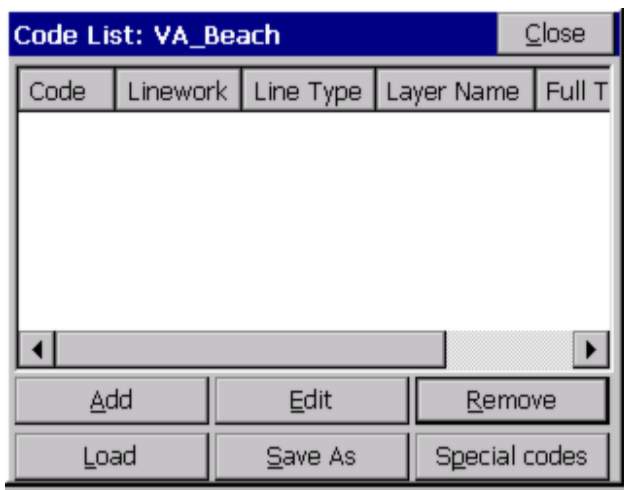

FCL (Feature Code List) files can be created, edited or reviewed on a PC using Carlson X-Port or any Carlson Surveying office software. (SurvCE’s FCL file is equivalent to Carlson’s Field-to-Finish FLD Table used in their PC office software. Transfer all PC Field-to-finish FLD table files using SurveyCOM or Carlson Export. Select the Field Code Table option to upload the FLD file to SurvCE as a FLC file.)

Defining Field Code Line/Layer Properties

To define codes with line/layer drawn features and, optionally, GIS prompting, select in the Code List pop-up box “Add” (as shown in the previous figure). The following Add Code pop-up box allows the operator to define Field Code

Line/Layer drawing properties.

The image shows a software dialog box titled "Add Code". It has a blue title bar with the text "Add Code" and two buttons: "OK" and "Cancel". The main area is light gray and contains several input fields. At the top, there are two text boxes for "Code:" and "Layer name:". Below that is a larger text box for "Full Text:". Further down, there are two dropdown menus: "Polyline On:" and "Polyline is 3D:", both currently set to "YES". At the bottom of the dialog is a button labeled "New Attributes".

- **Code:** Input one-word Field Code
- **Layer Name:** Defines the layer the linework 2D & 3D will draw in using Store Points
- **Full Text:** User defined full text description for code
- **Polyline On:** Yes or No defines to draw or not to draw between similar codes e.g. EP, EP1
- **Polyline is 3D:** Yes or No Yes draws in 3D, No in 2D
- **New Attributes:** This highlights after inputting all the Line/Layer drawing properties

The following EP code has been input in the FCL file. When Surveying using Store Points in the Survey menu, inputting field codes EP, EP1, EP2 and so on will draw 3D Polylines between these similar codes in the EOP layer. A 3D Polyline will be drawn in real-time when collecting data and inputting EP or EP# codes in Surveyed points descriptions.

As mentioned above, "New Attributes" becomes highlighted after inputting all the Line/Layer drawing properties. GIS prompting information can be added for this field code. If no GIS prompting is applicable for this field code, simply pick OK and create another field code, or exit and store the FCL file.

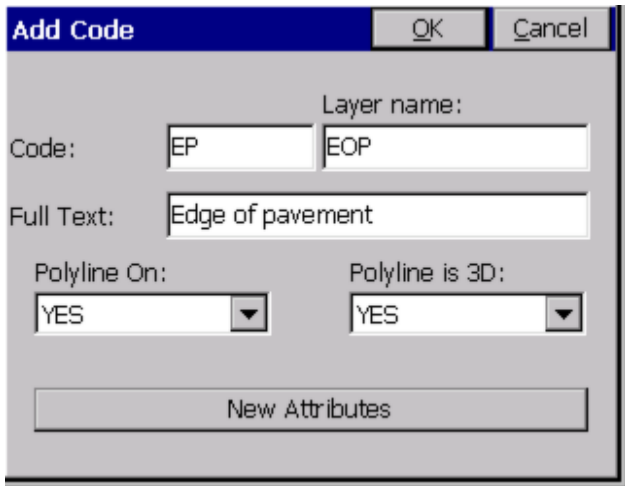

Defining Field Code GIS Prompting

To add GIS prompting to a defined Line/Layer code, select “New Attributes”. This button can be seen in the above figure at the bottom of the dialog. The following GIS Feature pop-up box is displayed. See the next figure below. To define GIS prompting for the EP field code, select “Add” in the Feature dialog shown below. The next pop-up box that appears, titled New attribute, is then displayed (shown below, underneath the Feature dialog). The New attribute dialog creates GIS prompting.

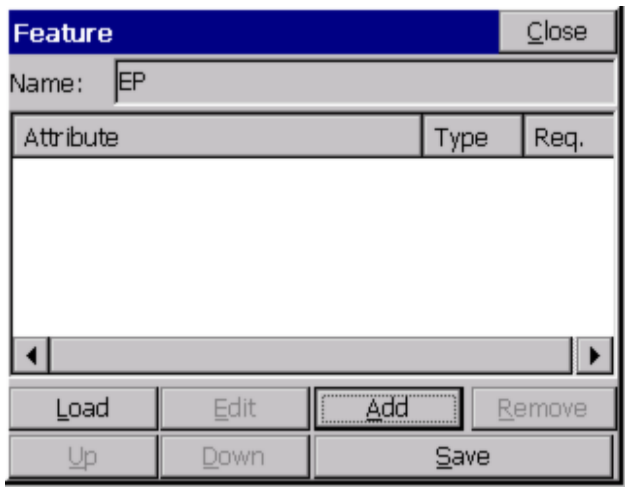

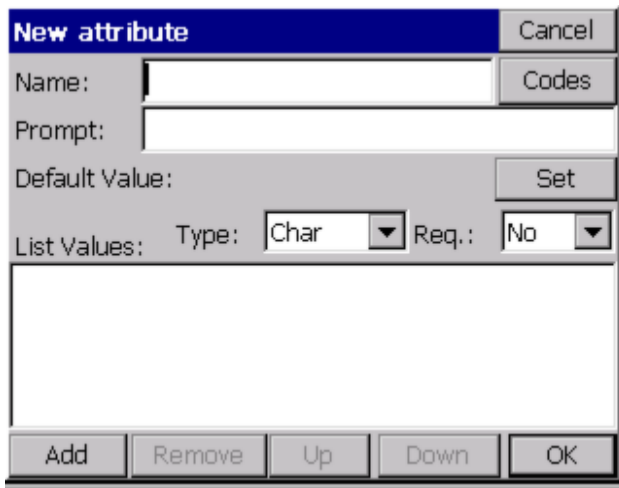

Load will load any existing Field Code GIS prompting for reuse. **Edit** reviews or revises existing GIS prompting. **Add** creates individual GIS prompting, as shown in the figure immediately above (New attribute dialog). **Remove** deletes any highlighted GIS attribute. **Up and Down** reorders the sequence of GIS attribute prompting. **Save** stores input or edited GIS prompting and exits to Line/Layer drawing properties.

Defining GIS Prompting

- **Feature Code Name:** No spaces GIS title for database
- **Codes:** Special codes, e.g. Date, Time, Lat, Long.
- **GIS Prompt:** Including spaces full name for GIS
- **Default Value:** Most common GIS value/default value
- **Set:** Lets the operator highlight and select the default value if there is a List of attribute Values.
- **Type:** Offers 4 options CHAR, INT, REAL and Code. Code Type will default to character type corresponding to special Codes. Codes can be Char, Int. or Real automatically.
- **Req:** Requisite/required entry. Operator cannot leave any GIS prompt empty when this field is set to Yes.

To add GIS attribute prompting for List Values, select the “Add” button within the New attribute dialog, as shown immediately below. The figure below that shows the New value pop-up box. The operator inputs, after selecting Add again, for each possible material (e.g. macadam, concrete, brick, stone cobbles and so on).

New attribute Cancel

Name: MATERIAL Codes

Prompt: Road Surface

Default Value: Set

List Values: Type: Char Req.: No

Add Remove Up Down OK

New value Cancel

MATERIAL

Macadam

OK

The data input for all GIS List Values is shown in following figure below. Note that Macadam is highlighted and will be the default value. If there are more than six attribute List Values, scroll bars will appear. This defines only one GIS entry Material for the EP field code. Each GIS prompt for the field code EP (e.g. Material, Location, Condition, Width, Slope and so on) will require being created using Add in the Feature pop-up box, as shown earlier in this tutorial.

New attribute Cancel

Name: Codes

Prompt:

Default Value: Set

List Values: Type: Req.:

Macadam
Concrete
Brick
Cobbled Stones

Add Remove Up Down OK

Add, Remove, Up and Down pertain to GIS List Values prompting. Add and Remove create or delete List Values entries. Up or Down reorders the highlighted List Value up or down. OK exits the GIS prompting screen retaining the GIS prompting entries and Cancel exits and discards all new inputs. The completed GIS field code for EP is shown below in the Feature dialog.

Feature Close

Name:

Attribute	Type	Req.
MATERIAL	Char	No
LOCATION	Char	Yes
CONDITION	Char	Yes
WIDTH	Char	Yes
SLOPE	Char	No

Load Edit Add Remove
Up Down Save

With all of the GIS Features input – Material, Location, Condition, Width and Slope – the operator can now select Save to store the GIS prompting for the field code EP. When storing points in the Survey menu in Store Points with EP or EP#, 3D linework when ended will prompt for EP GIS data as defined here. If 2D or 3D linework is created the GIS data will be attached to the linework. Note that Location, Condition and Width are required input GIS fields. Load allows selecting any existing field codes GIS prompting for reuse. Edit reviews or revises existing GIS prompting. Remove deletes highlighted GIS attribute prompting. The Up and Down buttons will reorder GIS attribute prompting. Save stores and exits.

Importing & Exporting GIS Information from SurvCE

SurvCE imports and exports ESRI SHP files. SurvCE solely uses ESRI SHP files to interface with all GIS programs. ESRI SHP files are open architecture and are a widely used and accepted GIS format for most common GIS packages. To import or export GIS data to or from SurvCE, select in MAP – File – SHP File – Import or Export SHP File (Quick Import or Export only reads and writes the drawing entities and doesn't include the GIS info). There are two figures later in this tutorial that depict this.

SurvCE Creates Three ESRI GIS Drawing Objects: Points, Arcs (Polylines) and Polygons (Closed Polylines)

There are only three types of drawing entries in ESRI SHP files points, arcs (open 2D or 3D Polylines) and polygons (closed 2D or 3D Polylines). The EP field code creates points and arcs and/or polygons. GIS information is stored only to the arcs or polygons and not the EP points. All GIS information for EP will be attached to the 3D Polylines. The second Field Code UP in the FCL job file creates points only with no linework. The UP field code attaches GIS information to the UP points. See the next two figures below.

The screenshot shows a 'Feature' dialog box with a 'Close' button in the top right corner. The 'Name' field contains 'ep'. Below the name field is a table with three columns: 'Attribute', 'Type', and 'Req.'. The table contains the following data:

Attribute	Type	Req.
UP_NO	Char	Yes
HGT	Char	No
CONDITION	Char	Yes
COMMENTS	Char	No

Below the table is a horizontal scrollbar. At the bottom of the dialog are two rows of buttons: the first row contains 'Load', 'Edit', 'Add', and 'Remove'; the second row contains 'Up', 'Down', and 'Save'.

Add Code OK Cancel

Code: Layer name:

Full Text:

Polyline On: ▼

Save Feature Code List File

With two field codes (EP and UP) with GIS information input and stored, using option 5 “Feature Code List” (in the File main menu), let’s collect some Survey data in Store Points with GIS information. First, Save As these two codes into a Feature Code List file, as shown below.

Code List: VA_Beach Close

Code	Linework	Line Type	Layer Na...	Full Text
EP	Yes	3D	EP	Edge of
UP	No	3D	UTILITY	Utility Po

◀ ▶

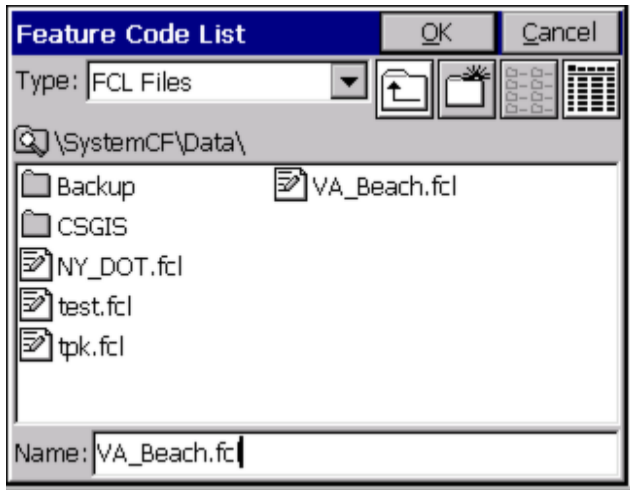

The Add and Edit buttons create or revise Line/Layer drawing properties and GIS prompting. Remove deletes field codes highlighted. Load unloads the current FCL file and loads another existing FCL Field Code List.

Collecting & Storing GIS information in SurvCE

To demonstrate collecting Survey data with GIS information, SurvCE is set to either Manual Total Station or GPS Simulation.

For Manual Total Station, go to the menu Survey – Store Points (see the next two figures). Follow the figures for Manual Total Station. It is important, in the main menu, that File – Configure Reading – HGT/Desc Prompt on Save is toggled ON!

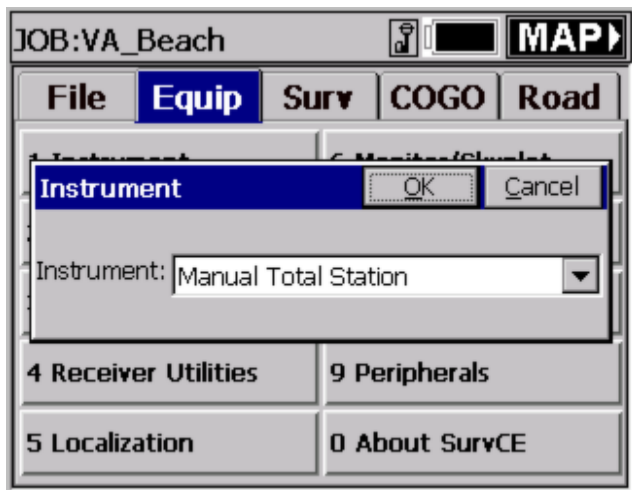

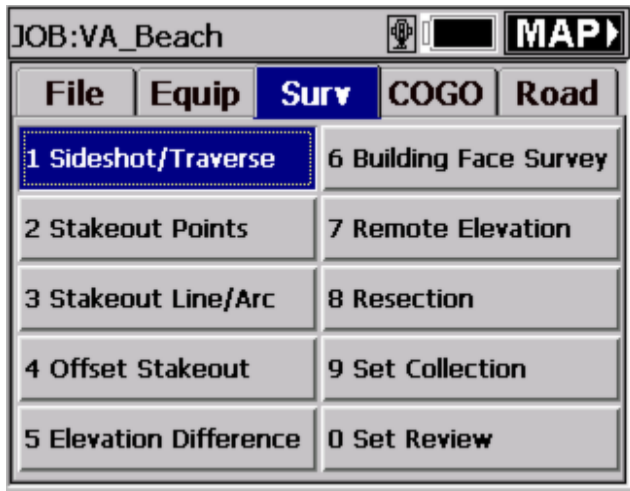

For GPS Simulation, go to the menu Survey – Store Point (see the next two figures) and follow figures for GPS Simulation.

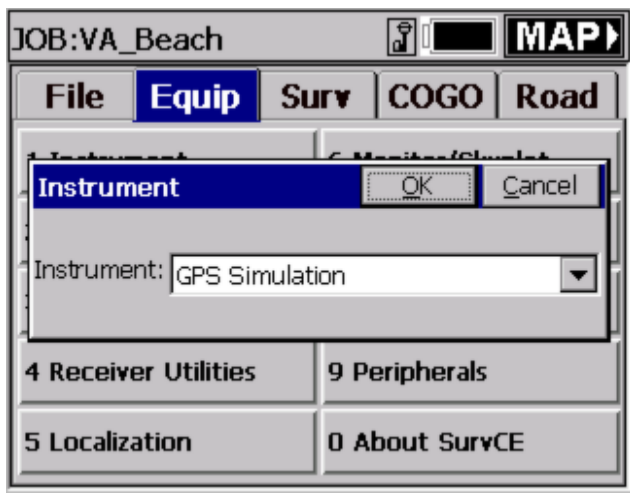

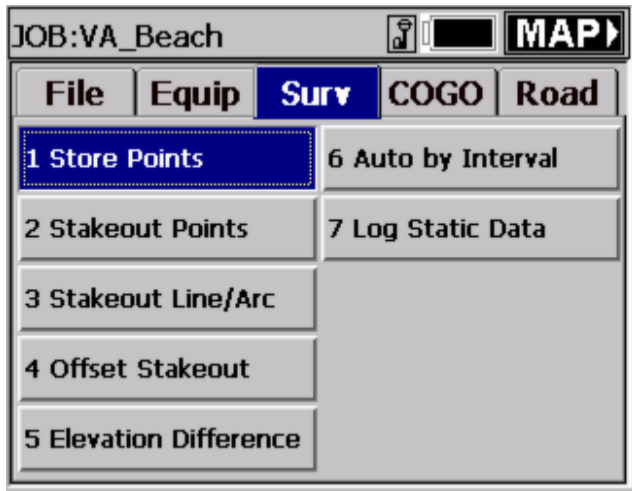

See these Manual Total Station example screen captures, shown here in the next four figures.

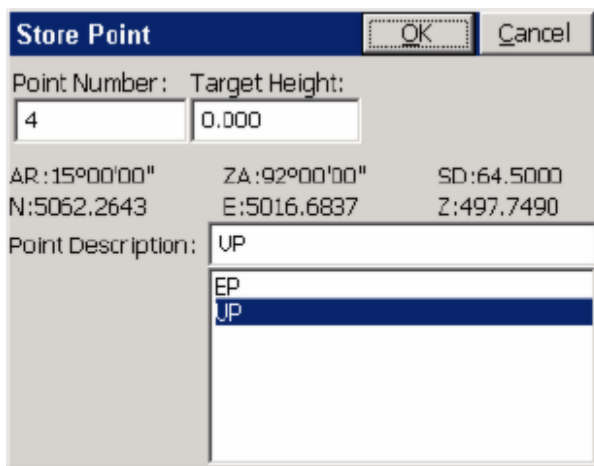

UP Cancel

Add(ID:4)>Utility Pole
(Char) UTILITY POLE NUMBER
101A
(Char) HEIGHT
35.5'
(Char) cond
Good
(Char) Comments
JSC Survey Manual Total Station

Next Previous Delete OK

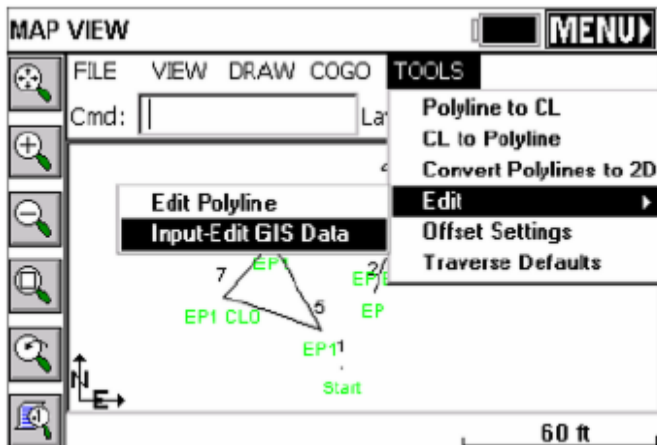
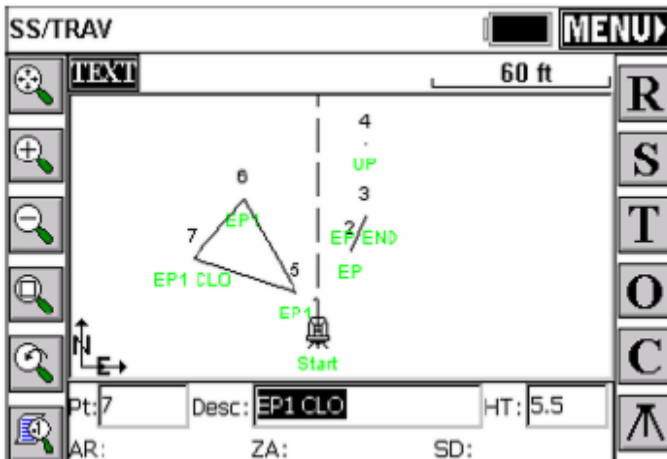

GPS Simulation screen capture examples are shown in these next four figures.

Store Point		OK	Cancel
Point Number:	Target Height:		
<input type="text" value="3"/>	<input type="text" value="3.281"/>		
N:5073.2243	E:5030.9588	Z:96.7679	
HRMS:0.045	VRMS:0.087	PDOP:3.200	
Point Description:	<input type="text" value="EP"/> <input type="text" value="EP"/> <input type="text" value="UP"/>		

Store Point		OK	Cancel
Point Number:	Target Height:		
<input type="text" value="3"/>	<input type="text" value="3.281"/>		
N:5073.2243	E:5030.9588	Z:96.7679	
HRMS:0.045	VRMS:0.087	PDOP:3.200	
Point Description:	<input type="text" value="EP END"/> <input type="text" value="EP"/> <input type="text" value="UP"/>		

<input type="text" value="EP"/>	Cancel
Add(ID:1036452394)>Edge of pavement	
(Char) Road Surface	
<input type="text" value="Macadam"/>	
(Char) Location - Street Numbers Name	
<input type="text"/>	
(Char) Condition	
<input type="text" value="Good"/>	
(Char) Measured Width	
<input type="text"/>	
Next	Previous
Delete	OK

The sequence of shoots started with GPS Simulation storing points 2 and 3 as EP codes. Point 3 was stored as EP END. A 3D Polyline was drawn between 2 to 3 and GIS prompting popped-up after point 3 was stored shown above. Note in the Condition field the operator input data not found in the default settings. Point 4 was stored using manual total station as a UP point code. Point 4's UP GIS prompting appeared after point 4 was stored. Points 5 through 7 were stored as a closed polygon. This was done by storing point 7 as EP1 CLO to close back to the start point 5 of the EP1 3D Polyline. The GIS prompting appeared for EP1 (not shown) and entered. The last sequence above was to exit Store Points and select MAP.

Editing GIS Information on Arcs and Polygons – Input-Edit GIS Data

To edit existing GIS information stored on Arcs (2D/3D Polylines) or Polygons (closed 2D/3D Polylines) in the MAP pop-up box, select Tools – Edit – Input/Edit GIS Data, and pick any polyline or polygon. There are two figures below. The top figure shows how the closed 3D Polyline between points 5, 6 and 7 was selected using this command. GIS data for the closed 3D Polygon is shown in the second figure.

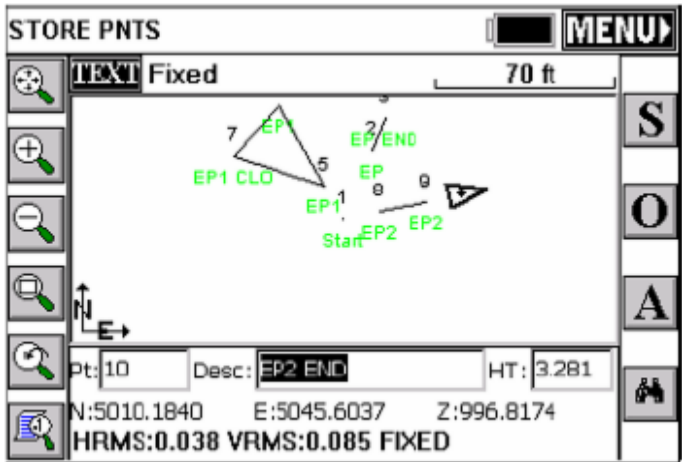

The above figure displays the next EP code EP2 stored using GPS Simulation. When ended with a END or CLO description after EP2 SurvCE will prompt for EP GIS data to attach to the polyline as defined above.

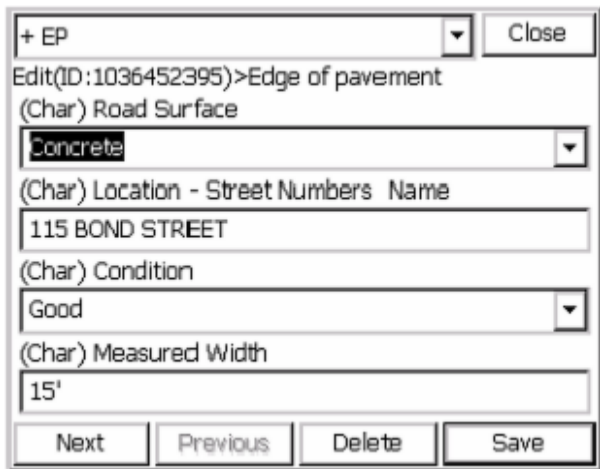

The figure above displays the ease of reviewing, creating or editing GIS data using Input-Edit GIS Data. From the MAP screen Input-Edit GIS Data was selected and the closed 3D Polyline picked on the screen. The GIS data stored prior was displayed for review or editing. Any data point, polyline or closed polyline could be selected using the Input-Edit GIS Data command in MAP and new GIS attached to this entity or existing GIS data reviewed and edited.

Editing GIS Information on Points using List Points

Input-Edit GIS Data only works creating, reviewing or editing GIS information on Arcs or Polygons. To create, review or edit GIS information on points use List Points shown below under File – 3 List Points.

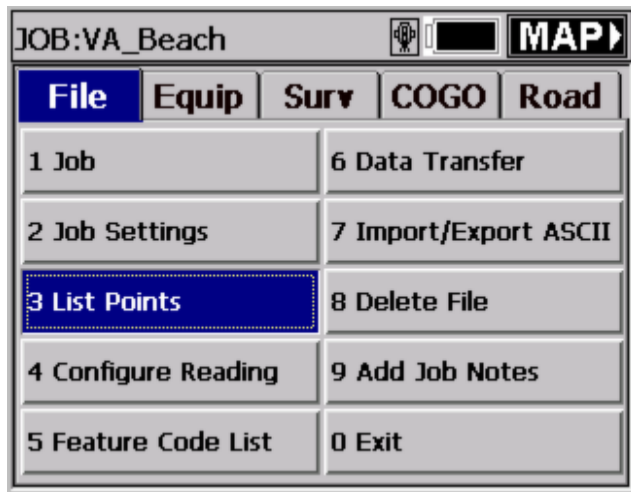

Pt ID	Northing	Easting	Elevation	Description	Pt IC
1	5000.00	5000.00	500.000	Start	1
2	5026.71	5011.29	996.722	EP	2
3	5038.22	5016.16	996.817	EP END	3
4	5062.26	5016.68	497.749	UP	4
5	5012.99	4992.50	105.000	EP1	5
6	5043.29	4975.00	104.127	EP1	6
7	5024.50	4957.57	104.145	EP1 CLD	7
8	5002.85	5014.01	996.801	EP2	8
9	5006.51	5032.35	996.807	EP2	9

Highlight point 4 and select Edit (see figure immediately above). Point 4 is the only Surveyed number with GIS data stored to the point. The Edit Point pop-up box appears, and can be seen in the next figure below. To create, review or edit GIS information select Input/Edit Attributes (See Figure 9-32).

Note: At the +UP box on top the down arrow can be selected and one or more GIS field codes could attach GIS data to this same point. Points, Arcs or Polygons can all have one or more GIS field codes attached to these entities.

Edit Point OK Cancel

Point ID: Edit Notes

Northing: **ft**

Easting: **ft**

Elevation: **ft**

Description:

+ UP Close

Edit(ID:4)>Utility Pole

(Char) UTILITY POLE NUMBER

(Char) HEIGHT

(Char) cond

▼

(Char) Comments

Exporting SurvCE GIS Data as ESRI SHP files

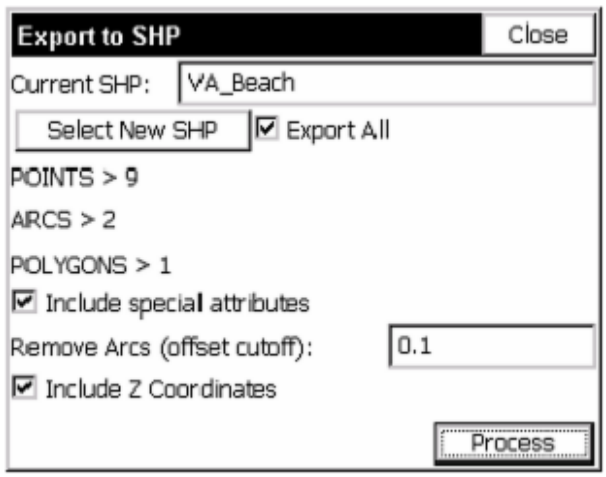
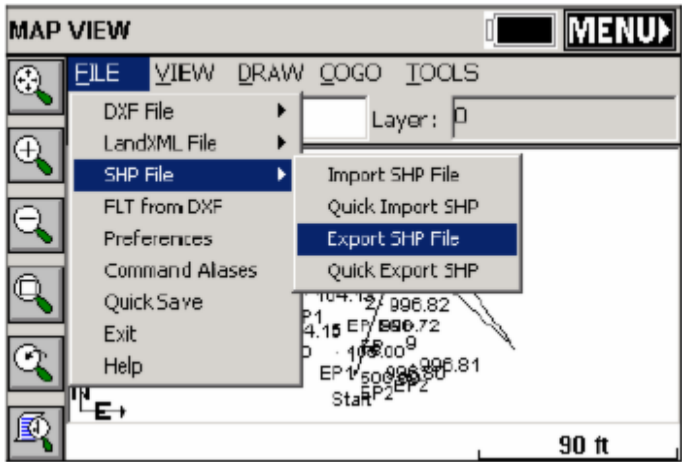

These final two figures, above, display the exporting of our VA_Beach MAP and GIS data. The ESRI SHP file consists of 9 points, 2 arcs and 1 polygon (closed polyline). Only one point, point 4, has UP GIS data. Two arc polylines and one polygon have EP GIS information attached. Note that Include special attributes is checked. This adds to polyline arcs and closed polygons the polylines length and area to the GIS data automatically. Process with Export All checked stores the VA_Beach three SHP files automatically to a user defined subdirectory and a fourth SHP file with 8 points without GIS data.

Tutorial 5: Standard Procedures for Conducting GPS Localizations

This tutorial is intended to assist users with the recommended localization method for SurvCE. Other methods can be used and it is up to the individual users to

determine which is best for them.

File Extensions

Localization File: *.dat

Geoid Model File: *.gsf

Coordinate File: *.crd

Raw Data File: *.rw5

Projections

It is essential that the proper plane coordinate projection is selected prior to creating a localization file. This should be the first step performed during the creation of the job file and be performed easily through File Job Settings GPS.

Geoid Model

An important item to note is if the user intends to use a geoid model (typical for localizations that contain less than 3 control points), the geoid model must be applied prior to the creation of the localization file.

A local portion of the geoid grid must be extracted from the Carlson Geoid Model using Carlson X-Port, SurvCOM, Survey or Civil/SurvCADD, and the geoid model file must be installed prior to the creation of the local geoid file. It is also highly recommended that the local geoid file grid size does not exceed 100 miles.

Web Link to the Geoid Files

<http://update.carlsonsw.com/public/CarlsonGeoidGrids.exe>

Transfer or Enter the Known (local) Points

It's a good idea to simplify the process by transferring the known (local) points to the data collector prior to going to the field. Conversely, the user can keyboard enter the known coordinates for these points into the CRD file, one at a time, using File List Points Add. It is not recommended that the user keys in the local coordinates from within the localization process as transpositions can occur easily. However, this can be done as well.

Collect the GPS Locations with Averaging

Using the Survey Store Points routine, specify your point ID. It is good to use something that will relate to the original known point. Example, if the known point for the first control point is 1, then you may want to collect the measured location as 1001.

Use the average reading icon <A> to collect several epochs of data at each point. Typically when using a 1 Hz receiver, 10 to 30 readings will be collected to ensure that the RTK solution is consistently reporting the same position for 10 to 30 seconds. On a 5 Hz receiver, the user may want to collect 50 or more readings as 50 readings would be 10 seconds.

Create the Localization File

Once the data collector has points that represent the known (local) coordinates and the measured data for these points, the localization file can be created.

Select Equip Localization Add to enter each point into the localization file.

Local Point

The first dialog presented to the user will be the Local Point dialog shown below. Enter the known (local) coordinate point ID or coordinates. If the point does not exist in the CRD file and coordinates are entered into this dialog, do not enter a point ID. Select OK when the known (local) position has been defined.

Local Point

OK Cancel

Please enter local coordinate values.
You may use a point number from
the current or control job.

Point From File:

Local Northing:

Local Easting:

Local Elevation:

GPS Coordinates

The next dialog presented will be the GPS Coordinates dialog shown below. Since the measured locations for each point has already been recorded, the user will want to use the option From Raw File in this dialog. Select OK to continue.

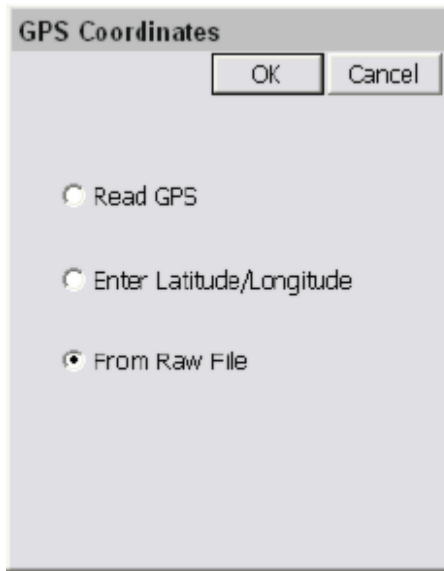

Surveyed Point

Next, the user will be presented with the Surveyed Point dialog shown below (top image). This dialog allows the user to select or enter the GPS measured point that represents the known (local) point. If the user selects the GPS measured point using the list icon, they should ignore the current coordinates displayed in the List Points dialog shown below (bottom image), as they only reflect the non-localized position at this point. The important thing to remember is that if the local point was 1, and the GPS measured point was 1001, the user must enter 1001 in this dialog.

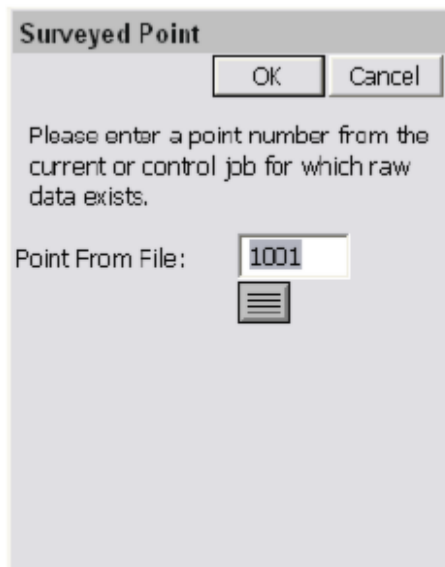

List Points			
Settings	Find	OK	Close
Pt ID	Northing	Easting	Elevati
* 1	5000.0000	5000.0000	100.00
* 1001	5017.9607	5007.5937	93.479

Save the Localization File

Once all of the points have been added to the localization dialog, save the localization file before exiting using the Save button.

Reprocess Raw File and Update Coordinates

At this point all of the coordinates in the CRD file that represent the measured positions need to be updated to reflect the newly created localization. To do this, select COGO Process Raw File and process the raw file through the localization file. This will update the previously measured GPS points. Verify that the positions look valid by viewing the points in File List Points. You should be able to compare the known and measured positions to see if they look right. Depending on the localization method, the measured values may not be exactly the same as the original known positions due to error that may have existed in the original positions.

Additional GPS Measurements

Once the localization is defined, all of the GPS points measured after its creation will be recorded to the CRD file based on this localization.

Changing the Localization

If the user determines that they want to redefine the current localization during a job, they must reprocess the entire raw file after making any changes to the localization file. It may be prudent to simply define a new localization file from scratch, leaving the original intact, and reprocess the raw file through this new localization file. Just remember that the last localization loaded, will be the current localization.

Selecting Projections for use in Localization

Whenever you select a projection or coordinate system, you can place it in a “most used” list of coordinate systems to choose from under the GPS tab in Job

Settings. This list can contain one projection system or many different systems the user selects.

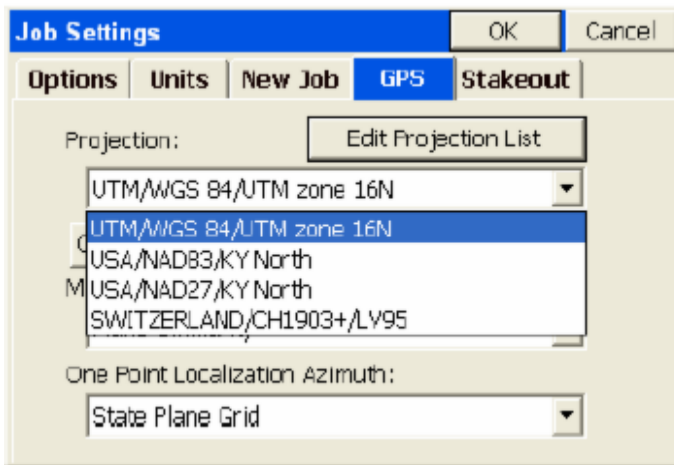

This is a special list of either predefined (eg. KY North NAD83) or user-defined coordinates systems. To get the list started or add to the list, select Edit Projection List and click Add Predefined. In the U.S., for example, surveyors might want to keep the UTM (WGS84) system plus the NAD83 and NAD27 “state plane” zones in the list for quick access, covering the region of your work. European and other worldwide zones can be added. When setting up a UTM selection, you can choose your zone, referencing the graphic below for the US:

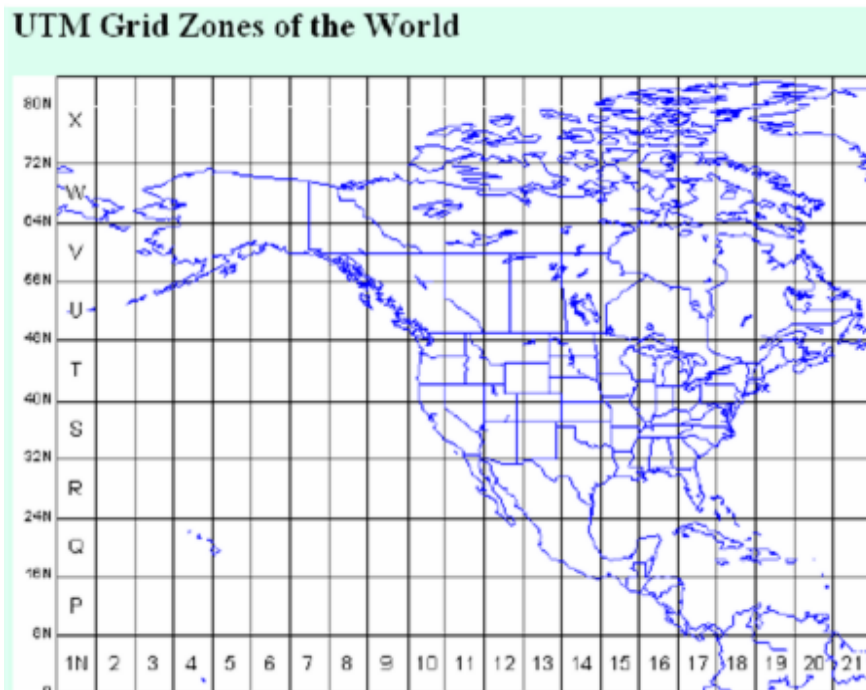

You can see a map of the UTM zones online at:

<http://www.dmap.co.uk/utmworld.htm>

To edit the list of saved projections, click on Edit Projection List. Here we select a user-defined UTM system from the list to Delete or Edit.

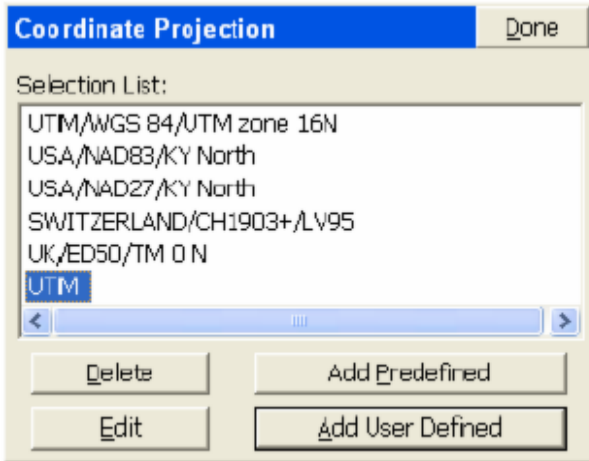

Choosing Edit will bring you to the screen below:

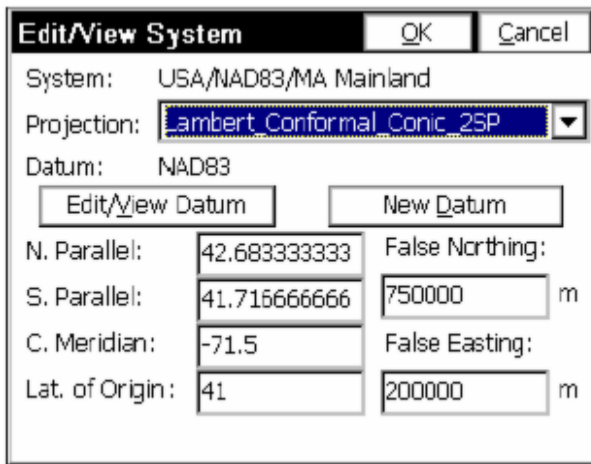

From this screen, you can select the Projection calculation method as well as calculation parameters. Projections include:

- Lambert Conformal Conic 2SP,
- Transverse Mercator,
- Oblique Sterographic (Double),
- Lambert Conformal Conic 1SP,
- Oblique Mercator 83,

Stereographic_Oblique_Mercator_27,
Transverse_Mercator_OSTN02,
Oblique_Stereographic_RD2000,
Oblique_Mercator,
Cassini_Soldner,
Transverse_Mercator_27,
Lambert_Conformal_Conic_27,
Transverse_Mercator_Alaska_27
Transverse_Mercator_34.

You may also use the buttons on this screen to edit the existing datum or create a new datum definition.

Define Coordinate System **OK** **Cancel**

Name: WGS84

Ellipsoid: WGS84~1

a: 6378137 m Scale (ppm): 0

1/f: 298.257223562776

dX: 0 m rot X: 0 °

dY: 0 m rot Y: 0 °

dZ: 0 m rot Z: 0 °

GSF File is relative to WGS84

The Datum definition screen is where you select the ellipsoid and Helmert parameters to apply.

If you select Add User Defined within the Coordinate Projection List screen, you proceed to the screen below:

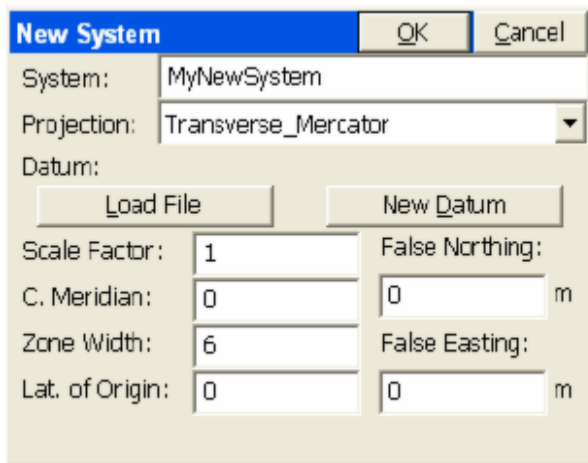

Here you enter the name of the new system and select the projection type and parameters, or you can “Load File” to load a pre-defined system stored earlier (in the form *.sys or *.csf).

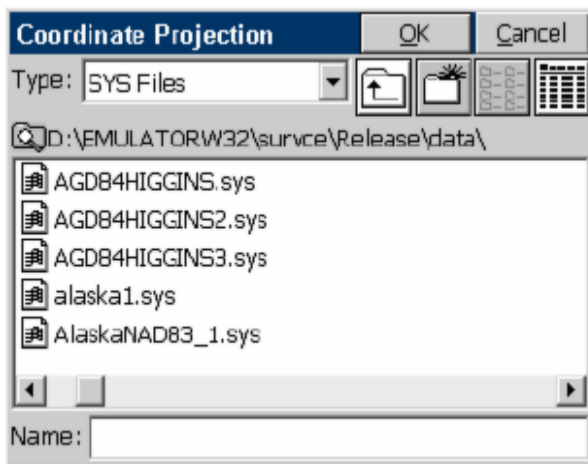

If you select “Add Predefined” to create a new, stored projection system, you will be presented with this screen:

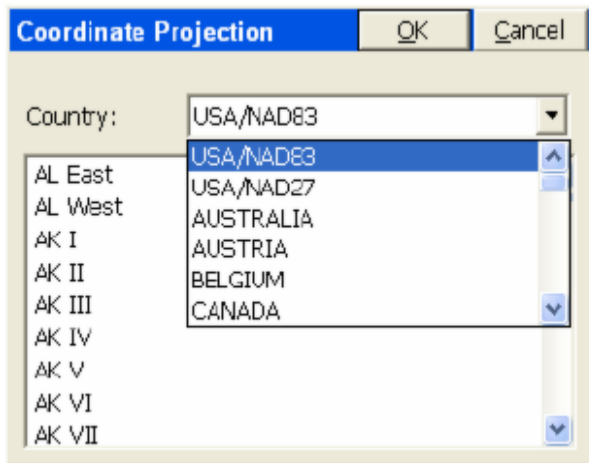

Here you can select the country and then the corresponding system for your area. There is a very extensive list of European and Asian systems including in the list.

The “quick-access” short list of most used projections enhances job efficiency.

GPS Utilities by Manufacturer

GPS Utilities (Leica 500/1200)

This command is used to configure the GPS radios and set the message type to use. This command is used to set radio configurations for both base and rover receivers. If SurvCE is used in conjunction with the Red Controller from Leica, a serial port to radio baud rate of 38400 is often pre-set. SurvCE should be set to conform to that baud rate. A useful feature of the Receiver Utilities is to verify the status of the receiver as either a Base or a Rover (bottom status line).

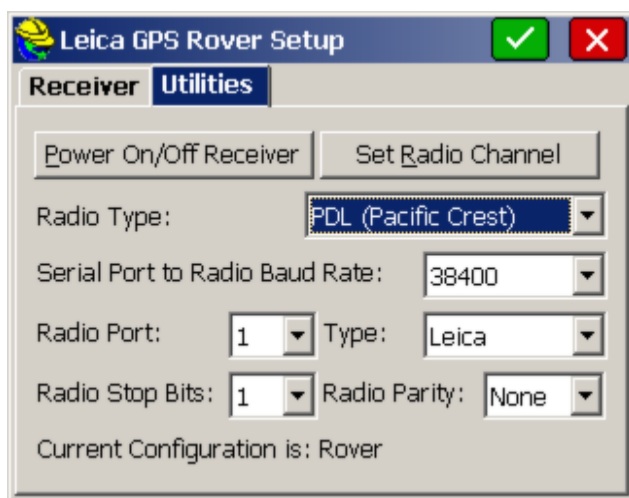

- **Power On/Off Receiver:** The receiver can be turned off and on in the command “Receiver Utilities”, option “Power On/Off Receiver”. The Configure Base and Configure Rover commands will typically turn on the receiver automatically. Sometimes, turning off and turning on the receiver can be used as a “troubleshooting” technique to clear conditions and start from a clean slate.
- **Radio Type:** The Pacific Crest PDL radio type is the default setting, operating at 38400 baud rate. Older Pacific Crest radios are often type RFM96W, defaulting to 9600 baud rate. Other options include Satel radios, Modems, RS232 and User Defined Modem. Phone numbers for cell modems will accept up to 49 characters. When using Freewave or Tait “spread spectrum” radios, the radio type doesn’t matter, but can be set to “User Defined Modem”. Baud rate for Freewave is often 19200 baud.

Connections: With Freewave and other spread spectrum radio linkages, communication must occur within a line-of-sight distance, typically no more than 2 to 5 kilometers except in very flat terrain. With PacCrest radios, the signal can “bend” somewhat, and achieve maximum distances

of 10 kilometers, typically. Cell phone linkage allows corrections to be transmitted within the coverage of the cell phones themselves and maintains accuracy up to as much as 50 kilometers. Contact your Leica GPS vendor for appropriate cables for connectivity details. When you select a modem configuration, the “Set Radio Channel” button becomes “Connect Modem”, and when tapped, you are prompted for a Phone Number or IP address and port (for the rover to call the base). The base must also be hooked to a cell phone or modem. The base can actually be set to both cell phone and radio linkage, with the rover set to either cell or radio as preferred. The rover will go from autonomous to float (cell phones are communicating) to fixed with cell phones just like with radio linkage.

Note: Base and rover GPS receivers must have matching radio configurations. If cell phones are used for the rover, then the base must be configured for cell phone use. If PacCrest PDL radios are used on the rover, than PacCrest PDL radios must be used on the base. Also note that cell phone switching is made possible through the C icon or Alt C “on the fly” from commands such as Store Points or Stakeout Points. This is because of the availability of a “Utilities Tab” in Configure Reading when configured Leica GPS.

Reference Station: To obtain corrections from a reference station to a single rover, you typically must set to cell phone or modem linkage, depending on what is required by the reference station.

- **Set Radio Channel:** This is normally set to channel 0 or channel 1. SurvCE allows up to 16 radio channels (0 to 15). The procedure is to pick the channel, then tap “Set Radio Channel”. Radios on base and rover must be set to the same channel.



- **Radio Ports:** The Leica GPS receiver has 2 commonly used radio ports (ports 1 and 3). Port 2 may be used in rare occasions.
- **Radio Stop Bits:** Typically set to 1.

- **Message Type:** Standard setting is Leica Proprietary. Other message string options are RTCM (an industry standard) and CMR (Trimble message string). RTCM and CMR are used when it is necessary to communicate with non-Leica GPS.
- **Radio Parity:** Typically set to None.

GPS Utilities (Navcom)

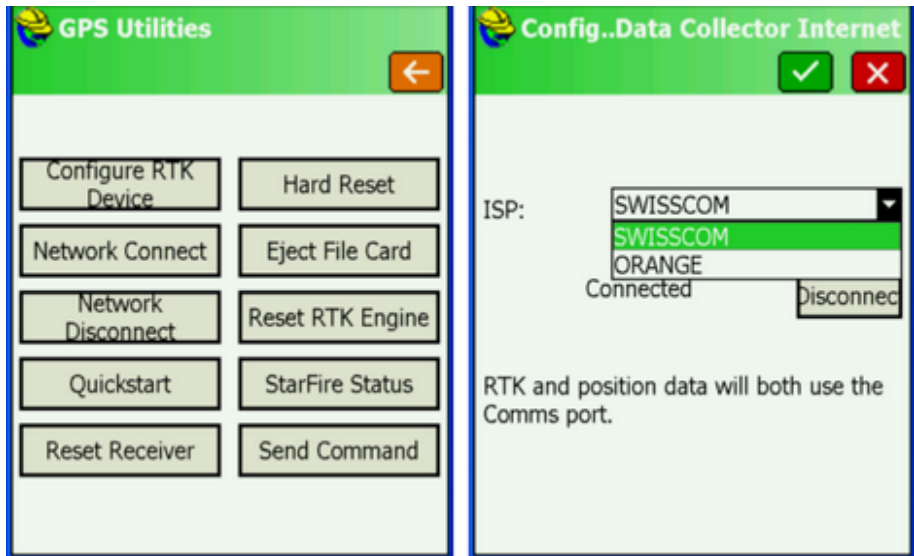

- **Configure RTK Device:** Use this page to change your RTK ISP (Internet Service Provider). The above example shows two European providers. In choosing providers, it is important to select a low cost plan and not keep the unit on longer than needed and incur unnecessary charges. When you exit SurvCE, you will also be prompted to disconnect the modem, so additional modem use charges are not incurred.
- **Network Connect:** This will attempt to connect to the network (such as NTRIP network), similar to clicking the Green Check (OK) within GPS Rover.
- **Network Disconnect:** This will disconnect from the network, and disconnect the modem, which may be beneficial to save costs.

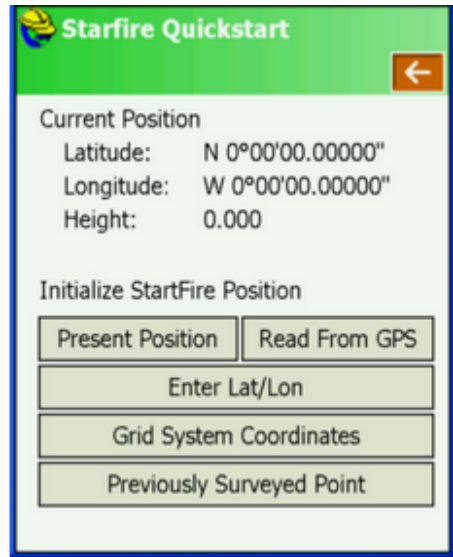
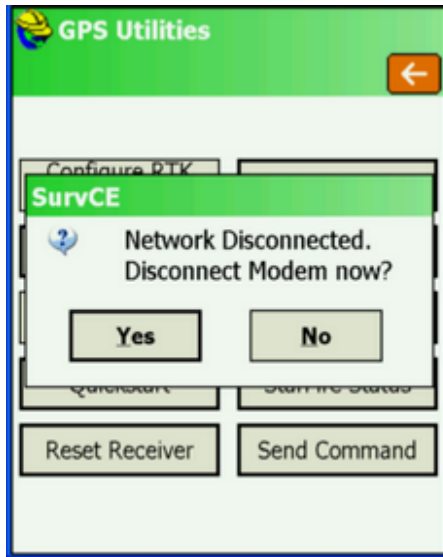

- **QuickStart (Starfire Only):** Starfire corrections often take some time to acquire high levels of accuracy. If you're returning to a previously surveyed area, you can save time by storing a known position to a reference file. Then you can initialize the Starfire system with this position upon returning to the site by performing a QuickStart.

At the end of the first day, verify that you're receiving Dual-Frequency Starfire corrections by entering the Navigation Status utility. Enter the QuickStart menu, and press **Read GPS**. Be sure to physically mark this position in some way so that the exact position can be returned to later. When you have a GPS position, click **Save** to save the position to a reference file. When you return to the site, first ensure that you're receiving dual-frequency Starfire corrections, and that you're set up on the position marked the previous day. Then enter the QuickStart menu and choose **Previously Surveyed Point**. Other methods of applying QuickStart are discussed in Instrument Setup by Manufacture, GPS (Navcom).

- **Reset Receiver:** Use this tool to reset your receiver (soft reset)
- **Hard Reset:** Use this tool to reset your receiver (factory reset).
- **Eject File Card:** This should be done before removing the data logging card containing any stored logged data. If you pull the card out without issuing this command first, you may lose data.
- **Reset RTK Engine:** Use this option when you are unsure if you have a good fixed position. In very rare cases, the resolving of ambiguities can lead to an outlier fix. The probabilities of this occurring consecutively are remote. Also use it if you are in a situation where the receiver will not report a fix. Use the Reset RTK Engine to reinitialize the process.
- **Starfire Status:** Press to verify Starfire Status (below), with options to select

alternate satellites. See section on Setup by Manufacturer, GPS (Navcom), for more detail.

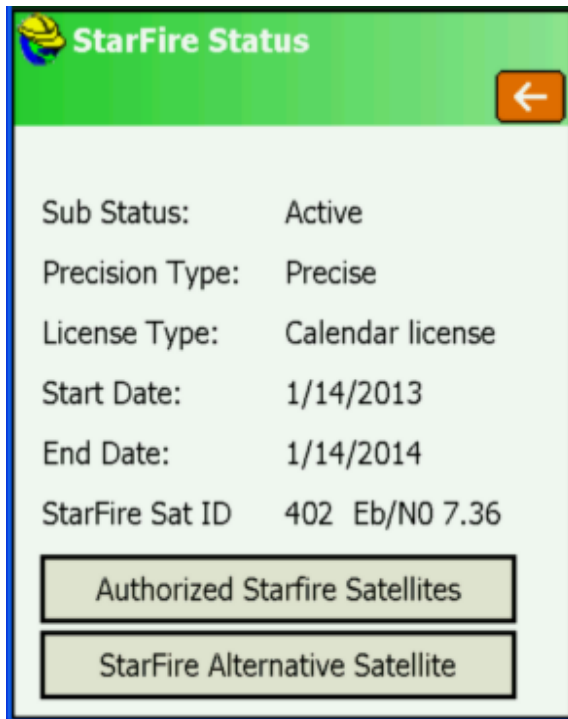

- **Send Command:** Sends a command to the receiver, sometimes used for troubleshooting during tech support.

The buttons available in Receiver Utilities depends on the capabilities of the receiver. If a Starfire license is not active, the QuickStart button is not shown.

“QuickStart” allows the user to save a QuickStart point or to QuickStart from a previously saved QuickStart point.

Starfire and QuickStart

Starfire is a space-based GNSS correction system capable of 5 cm horizontal accuracy. Vertical will be 1.5 to 2 times as much. The positions that it calculates are ITRF 2008. This is different from the positions calculated in RTK surveys.

It normally takes about an hour to get to the 5cm accuracy. The receiver does not have to be stationary during that time. QuickStart is a method of reducing the convergence time to 50 seconds. If a QuickStart point has been saved using the QuickStart dialog, it can be loaded and used to perform a QuickStart. Best results are obtained by performing the QuickStart 5 minutes after turning on the receiver.

Performing a QuickStart to a point with a position that is wrong will increase the

convergence time up to several hours. It will start at the bad position and then drift toward the correct position. It is better to not perform a QuickStart if the receiver has already been on for 30-40 minutes.

RTK Extend™

Introduction

An industry first from Navcom, RTK Extend™ enables continuous RTK position accuracy during radio communication outages by utilizing Navcom's global Starfire™ corrections. Traditionally, when an RTK rover loses communication with the base station, it is unable to continue to provide position updates for more than a few seconds, resulting in user down-time and reduced productivity. A Navcom Starfire receiver, operating in RTK mode, can transition to RTK Extend mode and maintain centimeter accurate positioning during communication loss for up to 15 minutes or in some cases even longer. RTK Extend allows the user to work more efficiently and without interruption, thus enabling them to concentrate on the work rather than the tools.

The Concept

Using a receiver capable of Starfire and RTK at both the base and the rover locations allows the receivers to compute Starfire and RTK solutions (or corrections) simultaneously. If a communication outage occurs and the rover stops receiving RTK corrections from the base station, the receiver automatically and seamlessly transitions to RTK Extend mode by employing the Starfire signal.

Using RTK Extend, under conditions of communications loss, and assuming the system has been fixed for at least 5 minutes prior, the receiver is able to compute an RTK equivalent position for up to 15 additional minutes. If the receiver remains in RTK extend mode for more than 15 minutes, the position solution will slowly degrade to the typical 10cm accuracy of the Starfire system. Once the communication link is restored, the rover automatically switches back to the standard RTK solution. The break in communications and the seamless mode transition of RTK Extend is designed to go unnoticed by the user with the exception of the mode flag indicating the receiver is operating in the Starfire-aided RTK Extend mode rather than standard RTK.

How it Works

To enable the RTK Extend process, the base station must compute a Starfire solution and constantly compare this position against the known RTK base station position. This difference information is transmitted to the rover as an additional RTK message. The difference results from two different sources: 1) The Starfire system inherently operates on the ITRF coordinate system and the solution will differ for the known base station position if it was entered using a different coordinate system. 2) Because RTK and Starfire use different techniques to compute a position solution at any given time there will be a few centimeters difference between the two solutions. The rover uses this difference information to prevent any position jumps from occurring when transitioning into or out of

RTK Extend mode such that the geodetic datum of the rover position will always be the same as the RTK base station position.

The RTK extend process works by continually forcing agreement between the Starfire and RTK rover solutions at every epoch while receiving a signal from the base station. Prior to initializing Starfire at each epoch, the RTK solution is modified by the delta received from the base station. By first applying the delta, Starfire is initialized to a true Starfire position but with a known offset from the desired RTK position.

When the system transitions to the RTK extend mode all that is required is to subtract the delta prior to outputting the position. Had the delta not first been applied to the RTK position prior to initialization, Starfire would immediately attempt to return to the correct Starfire position once it was no longer locked to the RTK position. In addition to the loss of accuracy that would result if the Starfire solution diverged from the RTK position there would also be a sudden position jump when the link to the base station was restored. Thus by making use of this additional information, the rover is able to extend RTK through position gaps that would normally result from loss of communication with the base station.

Frequently Asked Questions

Q: How long are the near-RTK level accuracies maintained if the communication link is lost?

A: To allow a Starfire receiver to work anywhere in the world, rather than just within a few kilometers of an RTK base station, unique processing techniques must be used and the typically obtainable accuracy is around 5 to 10 cm rather than the 1-2 cm obtainable with an RTK system. The errors that cause Starfire to fluctuate around the true position by a few centimeters change very slowly. As a result, once Starfire is initialized to a known position, it will stay within 1-2 cm of truth for many minutes, but within an hour or so will begin varying from the true position by a greater amount. Testing has determined that once initialized the Starfire position will stay within 1-2 cm of the true position for at least 15 minutes and in many cases even longer depending on the number of satellites visible and their geometry. Every time the receiver reestablishes the link to the base station and is able to compute an RTK position the 15 minute period is restarted. Thus RTK Extend will coast through several back to back outages as long as none of them are longer than 15 minutes.

Q: Can another manufacturer's receiver or Navcom receiver without Starfire capability be used as a base station?

A: Entering precise ITRF08 Starfire coordinates for the base position will allow the rover to make use of the RTK Extend feature although at a reduced level of performance. In this mode of operation, RTK Extend may only be able to coast through short outages of a few minutes. Depending on the length of the outage there is the possibility of a small position jump when transitioning from RTK Extend back to RTK. The coordinate transformation required to convert the local position into an ITRF08 position can be difficult, and if not done correctly will

cause the RTK Extend position to rapidly diverge from truth. As such, a GPS receiver capable of navigating in Starfire mode coupled with the ability to output the bias between these two sets of coordinates is the best approach to ensuring seamless operation.

Q: Which Navcom products are capable of RTK Extend?

A: Navcom's SF-2040 and SF-2050 product lines are capable of employing RTK Extend. (configured as "Navcom"). Newer models SF-3040 and SF-3050 also to RTK Extend. In order to be used in this mode, each receiver (base and rover) must have the RTK option enabled as well as an active Starfire license.

Q: Can a user define whether they want the RTK Extend™ feature to be active?

A: Yes. Each receiver is fully configurable to ignore or accept a variety of correction types. As such, the user may choose to disable the Starfire navigation ability, making the receiver a primary host to RTK, or vice versa.

Q: What is Starfire™ convergence or “pull-in”, and why is it necessary to achieve advertised accuracies from Starfire?

A: When positioning with GPS, there are two types of error sources that affect the accuracy obtainable 1) the errors generated by the GPS satellite system and 2) errors created by the receiver when processing the GPS signal.

The Starfire system is designed to compensate for all satellite based errors by continuously tracking the GPS satellites and calculating the clock and orbit errors in real-time. These errors affect all GPS receivers, but are removed by applying the Starfire corrections. Correcting for the remaining error created by the GPS receiver, involves a different process that must be done by the receiver itself. The process of eliminating these errors involves smoothing the code measurements for up to an hour during which time sufficient satellite geometry changes occur allowing these errors to be estimated. This process is called convergence or “pull-in”.

Q: What is Starfire QuickStart?

A: Navcom offers the unique feature called QuickStart where an accurately known ITRF08 position can be used to initialize Starfire navigation and greatly reduce the convergence period (to as low as 1 minutes or less). This is typically a position previously surveyed and converted to ITRF08 prior to initialization. It can also be a position obtained from the Starfire receiver while in steady state (or fully converged) navigation. For example, vehicular installations can be initialized using the last position from when it was parked and powered down. Employing QuickStart from a position that is not geodetic truth will be followed by a longer-term convergence to geodetic truth, so entering false coordinates into this function is not a recommended approach.

GPS Utilities (Sokkia and Novatel)

The NovAtel and Sokkia GPS options, like Ashtech, allow for hard and soft resets, permit sending commands to the receiver (consult your dealer) and allow the review and re-setting of base and rover radio channels for Pacific Crest PDL

and RFM series radios. Additional options check the communication status (shows the quality of the message string). The Review REF File will display the reference file (which stores the GPS base position information), which also helps in troubleshooting.

GPS Utilities (Magellan/Ashtech)

The Ashtech Receiver Utilities screen has the following options:

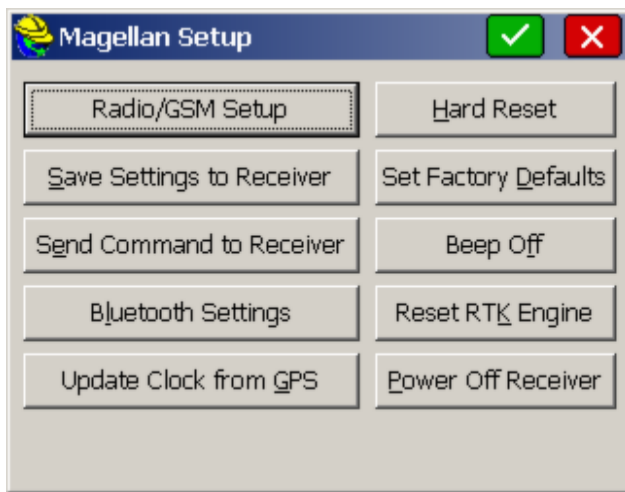

- **Base and Rover Radio/GSM Setup:** The Base and Rover Radio/GSM setup options will read the receiver, display the current radio channel, and allow the user to change to another channel. This feature is available for Pacific Crest PDL and RFM Series radios and Ashtech internal radios. Be sure that you have the right Radio Port set under the Configure Rover or Configure Base "Ports" tab. For GSM, see discussions under Configure Rover. The Base and Rover radio buttons work similarly. It is important for the user to choose the right button (base radio setup for base receiver and rover radio setup for rover receiver) to ensure that the software will try to connect to the radio on the correct port.

Ashtech Radio Setup – PDL

If the radio is an American PDL radio, it will appear as shown below.

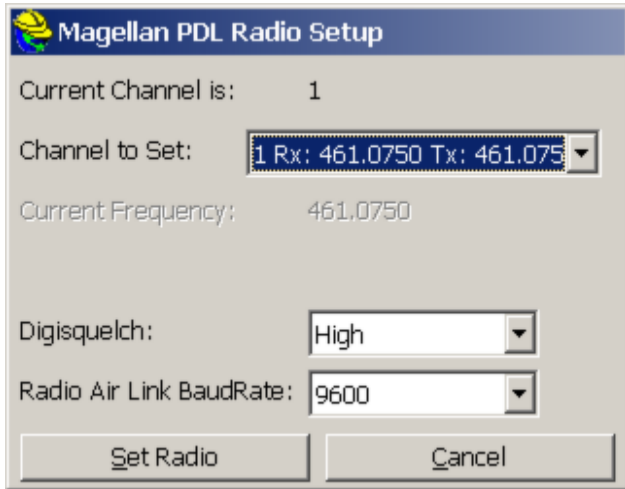

The user can change the channel, the digisquelch (sensitivity), and the over air radio link baud rate. If it is a European radio, channels are not available. Instead, the user will be able to set the frequency, the digisquelch, and the over air radio link baud rate. The digisquelch is best high on rovers and low on bases. To set changes, click on the Set Radio button and the following screen appears:

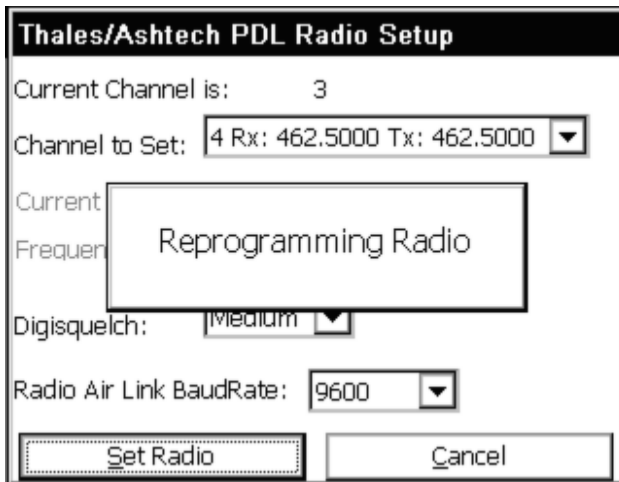

Ashtech Radio Setup – Thales UHF

Select the appropriate button (see above). The following screen will appear.

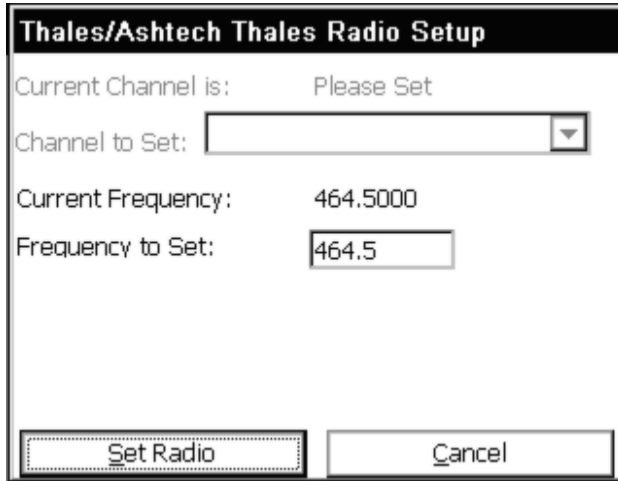

Change the frequency to the desired frequency and click Set Radio.

Ashtech Radio Setup – Cable

No configuration options are available when the software is configured to cable.

Ashtech Radio Setup – Older Receivers

Currently, the only radio option available for non-ZMAX Thales/Ashtech receivers is a PDL radio. The Base/Rover radio setup options will assume the radio is a PDL radio on these receivers, and try to configure them accordingly. All the same settings (channel, digisquelch, over air link rate) should still be available, however.

- **Hard Reset:** Shuts down the receiver and brings it up again with default settings. Resets all port baud rates to 9600 and resets the internal memory.
- **Set Factory Defaults:** Resets the receiver and changes all parameters to the factory defaults. It is useful in troubleshooting problems.
- **Save Settings to Receiver:** Use this command is issued as part of the Configure Base and Configure Rover operations. However, you can run this command at any time as an extra “confirmation” of your settings changes (including settings changes within Receiver Utilities). This sends the \$PASHS,\$SAVY command to the receiver.
- **Beep Off:** This disables the Beep sound that emanates from the Receiver when it is turned on.
- **Send Command to Receiver:** You can send what are known as “push” commands, internal Thales/Ashtech codes, to the receiver. This should be done only in consultation with your Thales dealer.
- **Reset RTK Engine:** This resets the carrier phase ambiguities. This is a useful command if you are having difficulty obtaining lock and want to start the process of fixing over again. Receiver settings are retained (so you can think of it as a “soft reset”).
- **Bluetooth Settings:** The Bluetooth settings in SurvCEs Bluetooth Manager

(discussed in Comm Setup) do not actually change anything in the receiver itself. In order to make changes to the receiver's internal Bluetooth settings, it is necessary to go into Receiver Utilities and click on Bluetooth Settings.

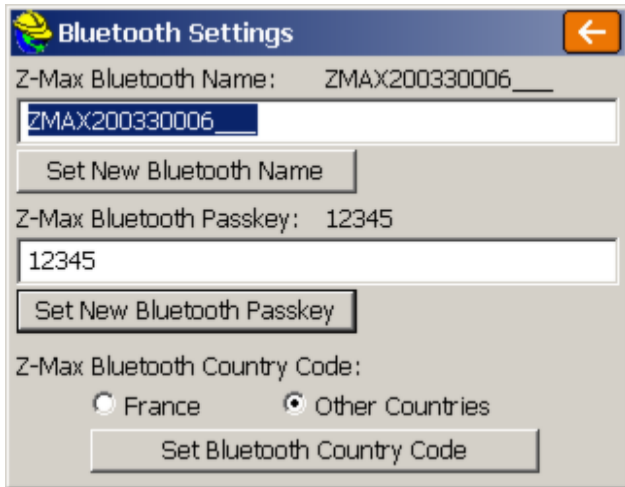

In this dialog, the user can change the Bluetooth receiver name (Receiver ID in Bluetooth Manager), the Bluetooth passkey (PIN in Bluetooth Manager), or the country code (currently the only choices are France and other countries because France has unique Bluetooth specifications). To change the name, change it in the appropriate text field and click Set New Bluetooth Name. A message confirming success will appear.

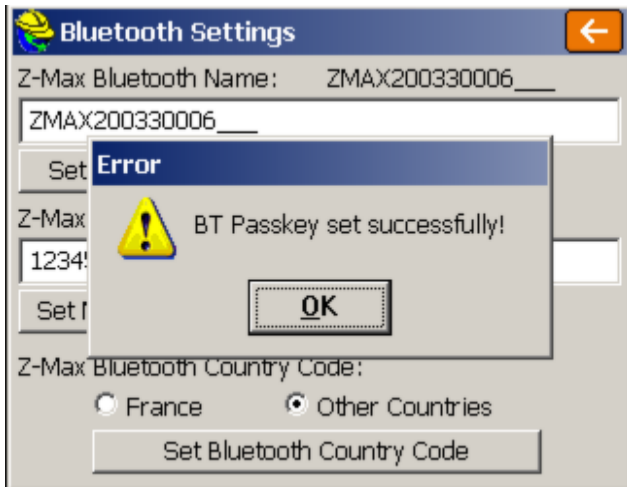

To change the passkey, change it in the appropriate text field and click Set New Bluetooth Passkey. A similar message confirming success will appear. To change the country code, click the appropriate radio button for the country and click Set Bluetooth Country Code. A similar message confirming

success will appear.

- **Power Off Receiver:** Sends a command to power off the receiver.
- **Update Clock from GPS:** This will update the clock on your CE device based on the time received from the GPS satellites.

GPS Utilities (Topcon)

- **Power Cycle Receiver:** This command is the same as turning the TOPCON receiver off and then on.
- **Restore Factory Defaults:** This command resets the TOPCON receiver to factory settings and the receiver stops acting as base or rover. The baud rate of Port A will be set to 115,200. Reset this to 9600 by turning the receiver off and then on while holding down the FN button. Watch the REC light go from orange to green to red and then let up the FN button. This method can be used if SurvCE cannot establish communications at any time.
- **Clear Non-Volatile Memory:** This command does everything Restore Factory Defaults does and also clears the almanac data that tells it where to look for the satellites. The receiver then downloads a new almanac from the satellites.
- **Send Command to Receiver:** This command allows experienced users to type in commands using TOPCON GPS receiver commands to set or report internal settings. (See the TOPCON operations manuals for a complete list of TOPCON GPS receiver commands).
- **Set Satellite Status:** This feature allows the user to disable a satellite if necessary.
- **Initialize to Known Point:** The Topcon GPS has a special feature to Initialize to a Known Point which can greatly speed up “move ups” from one base position to another.

GPS Utilities (Trimble)

- **Reset Receiver:** This will reset the receiver.
- **Select Rover Input:** If you choose Select Rover Input, you can identify the “station id” of the base to avoid picking up inappropriate base corrections from the wrong base receiver.
- **Check Battery:** This will display the condition of the receiver's battery.
- **Power On/Off Receiver:** This will turn on and off the receiver.

Troubleshooting

This chapter contains troubleshooting tips for Carlson SurvCE, and the various hardware devices supported by SurvCE.

GPS Heights

SurvCE records GPS heights as the ellipsoid height, expressed in meters, at either the phase center or the ARP of the antenna, depending on the GPS manufacturer. If the position is recorded to the ARP, then the LS record (antenna height) will only reflect the user-entered value. If the position is recorded to the phase center, then the LS record (antenna height) will reflect the user-entered value plus the phase center offset.

SurvCE records the ARP position for the following GPS manufacturers:

- Leica
- Geodetics

Handheld Hardware

How do I reset the computer after a lock up?

Ranger

Hold down the power button until the computer resets or instructs you to hold it for 5 more seconds to reset.

Allegro

Hold down the power button until the computer resets.

Why can't I load the software?

The computer may disconnect from ActiveSync when there is not enough memory allocated to "Storage Memory". In the control panel, select the "System" icon followed by the Memory tab. Position the slider so that there is 5mb (5120 kb) allocated and not in use (i.e. if the "In Use" value says 1024 kb then add 1024 & 5120 to determine what the "Allocated" value should be).

How do I clear the RAM backup and why?

Clearing the RAM backup seems to improve performance on the Ranger platform after new programs have been installed or removed. Make sure that all software applications are closed and select the "RAM Backup" icon from the control panel. Select the **Delete** button and answer **Yes** to the three resulting message boxes.

Why can't I communicate through the COM port?

If you cannot communicate with the instrument, verify all COM settings in SurvCE and make sure that they match the COM settings on the instrument. If communication has previously been working and the COM settings have not been altered, try one of the following to clear up the COM port:

- Exit SurvCE, turn off the computer, Restart the computer and re-enter

SurvCE.

- Exit SurvCE and perform a soft reset on the device (Verify that all applications have been closed).
- Exit SurvCE and perform a hard reset on the device (Verify that all applications have been closed).

How do I set the CAPS LOCK status?

Ranger

- 1) Hold down the yellow shift button [^] and the [ALT] buttons, then press and release the power button.
- 2) A small keyboard should be showing. On the small keyboard, press the [CAPS] button then repeat step 1 to dismiss the keyboard.

Allegro

Press and release the blue function button followed by the CapLk/Shift button located at the lower left side of the keyboard.

How frequently should I charge the device?

We recommend starting every day with a fully-charged battery. Refer to your hardware manual for specifics on charging your battery.

How do I calibrate the touch screen?

In the control panel of the CE device, select the “Stylus” icon to configure the “Double Tab” and “Calibration” of the touch screen.

How do I turn on/off the back light?

Ranger

Hold down the shift button [^] and then press and release the power button.

Allegro

Press and release the yellow function button followed by the F3/F8 button located at the top center of the keyboard.

How can I speed up the Allegro performance?

In the control panel of the Allegro, select the “System” icon and then the “Memory” tab. Set your “Storage Memory” allocation to 8000 KB or 8 MB +/- . This should provide more RAM to the system for operating the programs and increase performance.

How can I Recover the SurvCE Icon if it Disappears?

It may be possible to lose the SurvCE Icon off the desktop if, for example, the power drains out of the CE device. There are safeguards against this, but if it happens, follow these steps to restore the icon:

1. Select **Start** (lower left on most CE devices, Ctrl Esc on the Ranger) and choose **Windows Explorer** under **Programs**.
2. Navigate to the SurvStar directory (the directory containing SurvCE), which on some devices is \Disk\SurvStar.
3. Look for the SurvCE Shortcut and highlight it.
4. Choose the **Edit** pull down in Windows Explorer and choose **Copy**.
5. Then return to the desktop where the icons are visible and press **ALT** then

- tap into blank space on the screen (sometimes referred to as ALT-Click).
6. Choose Paste Shortcut. That should restore it.

If the icon disappears, this indicates some problem in the original installation of SurvCE, since a process occurs to make the icon permanent. You can help ensure that your restored icon is permanent by going to Start, Settings, Control Panel and choosing Perform Ram Backup. Select Backup Now, as prompted. This should make the SurvCE icon remain even after full loss of battery.

Can I lose data or get bad data if I Re-Boot my CE device?

If you re-boot your Allegro or Carlson Explorer or Ipaq or any other CE device you are using, you can lose your antenna height or prism height information, because SurvCE does not store to memory changes in antenna height or prism height, except in the following scenarios:

The hard save of antenna/prism heights is done when you exit the program, when you save a configuration from the instrument icon at the top of the screen, when you say OK to Configure Rover, Configure Base or Equip/Settings (for TS), when you change jobs, and when you enter Equip/Comm Settings. Prior to release 1.50.007, in November, 2004, even Configure Rover did not save the height information "to disk".

Therefore, if you re-boot, perform a hard reset, or otherwise exit the program by any method other than the normal File, Exit method, recent changes to the prism height or antenna height may not be saved. On re-entering the program, the X,Y position for GPS work, for example, will very likely be correct, but elevations may have been lost. When using GPS, it is recommended, after a re-boot, that you do the command Configure Rover to re-establish the correct elevations, and in all cases (GPS and Total Station) it is recommended that you double-check your antenna or prism heights before proceeding.

Miscellaneous Instrument Configuration

Leica Robotic - Do I need to be in RCS (Remote Control) mode?

You must verify that you are NOT in RCS mode when using SurvCE with Leica robotic equipment. It will appear as though you are not communicating with the instrument if this mode is active. Refer to the Leica documentation for how to exit RCS mode.

Leica GPS - What firmware will allow radio channel changing?

Firmware version 3.52 or later is required for SurvCE to have radio channel changing functionality.

Geodimeter 600 - What firmware version is required?

Firmware version 696-03.xx or later is required for SurvCE to operate with this instrument. To check the firmware on the instrument, follow the key strokes: Menu, 5, 4, 1. The Geodimeter 640, for example, does not take measurements in reverse face. Therefore, when doing D&R, set reverse face to angle only.

Sokkia GSR 2700 IS - What do I do when I get the Bluetooth pass key

prompt?

This receiver does not require a pass key. If you are prompted for one, do a factory reset on the receiver by holding the power key down until the message displayed is Factory Reset. Then turn the device off and back on again. In Carlson SurvCE, clear the receiver from the Bluetooth connections list and add it back in.

Supported File Formats

What file types does SurvCE use or convert?

- ALIISPOL Centerline File (Spain)
- ALN TerraModel Road Alignment File
- ALZ Form of CLIP Vertical Alignment File (Spain)
- ASC ASCII text file for point imports or Inroads Centerline File
- CL Carlson Horizontal Road Alignment File
- CR5 TDS Binary Coordinate File
- CRD Carlson coordinate file in binary form.
- DAT Carlson Localization File
- DXF Drawing file format that can be used for exchanging drawings.
- EGM Carlson EGM Geoid File
- FCL Carlson Field Code Library file.
- FFF Older form of Caice Cross Section File
- FLT Carlson Triangulation Mesh File
- G99 Carlson Geoid99 File
- GRD Carlson Grid File
- GSI Leica file extension for Raw files, Roading files, etc.
- INF Carlson User Preferences Settings File
- INP MOSS Roading Files (Horizontal and Vertical Alignment)
- LIS Form of IGRDS Cross Section File
- NOT Carlson Note File
- OBS Geodimeter Coordinate File
- OSD A form of Geopak Centerline File
- PLTHorizontal Alignment Report file from CLIP (Spain)
- POS Sokkia or Trimble Coordinate File
- PRO Carlson Vertical Road Alignment File
- RAS ISPOL Vertical Road Alignment File (Spain)
- RD5 TDS Road Alignment File
- RDS IGRDS Cross Section File
- REF Carlson Base Station Reference File
- RLN TerraModel Road Alignment File

- RW5 Carlson Raw Data File, TDS Raw Data File
- SC1SPOL Cross Section File (Spain)
- SCT Carlson Cross Section File
- SDR Sokkia file extension for Raw Files, Roading files, etc.
- SHP ESRI Shape File
- SUP Carlson Road Superelevation File
- TPLCarlson Road Template File
- TPT Carlson Road Template Transition File
- TRV Traverse PC Coordinate File and CLIP Format for Sections (Spain)
- XML LandXML File may contain a variety of file types (eg. Roading/DTM)
- XRS Form of Geopak Cross Section File

Raw Data

This section outlines the Carlson SurvCE RW5 format.

File Format

Carlson SurvCE RW5 Format

This document outlines the Carlson SurvCE RW5 format in detail. The format is a comma delimited ASCII file containing record types, headers, recorded data and comments.

The format is based on the RW5 raw data specification, with the exception of angle sets. Angle sets are recorded as BD, BR, FD and FR records to allow reduction of all possible data that can be recorded by Carlson SurvCE using the **Set Collection** routine. Essentially, these records are identical to a sideshot record.

With the exception of the aforementioned angle set records, if the RW5 specification is modified to provide enhanced functionality, the added or modified data will reside in comment records to avoid incompatibility with existing software.

Backsight Record

Record type: BK

Field headers:

OP	Occupy Point
BP	Back Point
BS	Backsight
BC	Back Circle

Sample(s):

BK,OP1,BP2,BS315.0000,BC0.0044

Job Record

Record type: JB

Field headers:

NM	Job Name
DT	Date
TM	Time

Sample(s):

JB,NMSAMPLE,DT06-27-2003,TM14:21:53

Line of Sight Record

Record type: LS

Field headers:

HI	Height of Instrument
HR	Height of Rod*

*GPS heights may be recorded to phase center or ARP depending on GPS make.

Sample(s):
LS,HI5.000000,HR6.000000
LS,HR4.000000

Mode Setup Record

The mode setup will be recorded at the beginning of the raw data file.

Record type: MO

Field headers:

AD	Azimuth direction (0 for North, 1 for South)
UN	Distance unit (0 for feet, 1 for meter)
SF	Scale factor
EC	Earth Curvature (0 for off, 1 for on)
EO	EDM offset(inch)

Sample(s):
MO,AD0,UN0,SF1.00000000,EC1,EO0.0,AU0

Occupy Record

Record type: OC

Field headers:

OP	Point Name
N	Northing (the header is N space)
E	Easting (the header is E space)
EL	Elevation
--	Note

Sample(s):
OC,OP1,N 5000.00000,E 5000.00000,EL100.000,--CP

Off Center Shot Record

Record type: OF

Field headers:

AR	Angle right
ZE	Zenith (actual)
SD	Slope Distance

Sample(s):
OF,AR90.3333,ZE90.0000,SD25.550000
OF,ZE90.3333,--Vert Angle Offset

Store Point Record

Record type: SP

Field headers:

PN	Point Name
N	Northing
E	Easting
EL	Elevation
--	Note

Sample(s):
SP,PN100,N 5002.0000,E 5000.0000,EL100.0000,--PP

Traverse / Sideshot Record / Backsight Direct / Backsight Reverse /

Foresight Direct / Foresight Reverse

Record type: TR / SS / BD / BR / FD / FR

Field headers:

OP Occupy Point
FP Foresight Point

(one of the following)

AZ Azimuth
BR Bearing
AR Angle-Right
AL Angle-Left
DR Deflection-Right
DL Deflection-Left

(one of the following)

ZE Zenith
VA Vertical angle
CE Change Elevation

(one of the following)

SD Slope Distance
HD Horizontal Distance
-- Note

Sample(s):

TR,OP1,FP4,AR90.3333,ZE90.3333,SD25.550000,--CP
SS,OP1,FP2,AR0.0044,ZE86.0133,SD10.313750,--CP
BD,OP1,FP2,AR0.0055,ZE86.0126,SD10.320000,--CP
BR,OP1,FP2,AR180.0037,ZE273.5826,SD10.315000,--CP
FD,OP1,FP3,AR57.1630,ZE89.4305,SD7.393000,--CP
FR,OP1,FP3,AR237.1612,ZE270.1548,SD7.395000,--CP

GPS

Record type: GPS

Field headers:

PN Point Name
LA Latitude (WGS84)
LN Longitude (WGS84, negative for West)
EL Ellipsoid elevation in meters*
-- Note

*GPS heights may be recorded to phase center or ARP depending on GPS make.

Sample(s):

GPS,PN701,LA42.214630920,LN-71.081409184,EL-21.8459,--CP /Brass Disk

Alphabetical listing of Record Types

BD Backsight Direct
BK Backsight
BR Backsight Reverse
FD Foresight Direct
FR Foresight Reverse
GPS GPS Position in Lat (dd.mmss) Lon (dd.mmss - Negative for West) and
WGS84 Ellipsoid Elevation in meters

JB Job
 LS Line of Sight
 MO Mode Setup
 OC Occupy
 OF Off Center Shot
 SP Store Point
 SS Side Shot
 TR Traverse
 -- Note Record

Alphabetical listing of Field Headers

AD Azimuth Direction (0 for North, 1 for South)
 AL Angle-Left
 AR Angle-Right
 AZ Azimuth
 BC Back Circle
 BP Back Point
 BR Bearing (this field will be recorded as N123.4500W)
 BS Backsight (when back point is not defined)
 CE Change Elevation
 DL Deflection-Left
 DR Deflection-Right
 DT Local Date (MM-DD-YYYY)
 E Easting (the header is E space)
 EC Earth Curvature (0 for off, 1 for on)
 EL Elevation (GPS value is ellipsoid elevation in meters)
 EO EDM Offset
 FE Foresight Elevation
 FP Foresight Point
 HD Horizontal Distance
 HI Height of Instrument
 HR Height of Rod
 LA Latitude
 LN Longitude
 N Northing (the header is N space)
 OC Occupy Point Coordinates
 OP Occupy Point
 PN Point Name
 SD Slope Distance
 SF Scale Factor
 TM Local Time (HH:MM:SS)
 UN Distance Unit (0 for feet, 1 for meter, 2 for US feet)
 VA Vertical Angle
 ZE Zenith
 -- Note

Index

- A -

Abbreviations 43
About SurvCE 205
Add Job Notes 128
Areas 338
Authorizing SurvCE 20
Auto By Interval 313

- B -

Basics 492
Battery Status 23

- C -

Calculator 354
Carlson Cloud 36
Carlson Technical Support 25
Centerline Editor 373
Check Level (Total Station) 198
COGO 549
Color Screens 22
Configure (General) 166
Configure (Sets) 176
Configure (View Pt) 174

- D -

Data Transfer 115
Delete File 127
DRAW 525
Draw Centerline 380
Draw Profile 383
Draw Template 389

- E -

Elevation Difference 282
End-User License Agreement 6
Exit 129

- F -

Feature Code List 88
FILE 498
File Format 631

- G -

GPS (CSI - DGPS Max)
GPS Base 146
GPS Heights 626
GPS Rover 154
GPS Setup 140
GPS Utilities 164
GPS Utilities (Leica 500/1200) 613
GPS Utilities (Magellan/Ashtech) 621
GPS Utilities (Navcom) 615
GPS Utilities (Sokkia and Novatel) 620
GPS Utilities (Topcon) 625
GPS Utilities (Trimble) 625
Graphic Mode 26
Graphics Screen Expansion 245
Grid/Face 288

- H -

Handheld Hardware 626
Hardware Notes 22
Hot Keys & Hot List 32

- I -

Import/Export 121
Input Box Controls 39
Installing SurvCE 15
Instrument Selection 38
Intersections 339
Inverse 336

- J -

Job 45
Job Settings (New Job) 46
Job Settings (Options) 51
Job Settings (Stake) 63

Job Settings (System) 48

- K -

Keyboard Input 334

Keyboard Operation 42

- L -

Leveling 304

List Points 74

Localization 178

Log Raw GPS 316

Logging 259

- M -

Manual Traverse 360

Master Centerline 259

maximize the graphics 245

Memory 23

Microsoft ActiveSync 12

Miscellaneous Instrument Configuration 628

Monitor/SkyPlot (GPS) 195

- N -

Navigate Data 245

- O -

Orientation (Backsight) 210

Orientation (Instrument Setup) 207

Orientation (Remote Benchmark) 212

Orientation (Robotics) 225

- P -

Peripherals 200

Pipes 389

Point Average 363

Point Projection 344

Profile Editor 380

- Q -

Quick Calculator 30

- R -

Raw Data 77
Receiver (GPS)
Reconnect 245
Reference Centerline Example 259
Remote Elevation 315
Resection 291

- S -

Save System 24
Set Collection 296
Stake Line/Arc 259
Stake Offset 278
Stake Points 245
Stake Road 445
Stake Slope 412
Stake Station Interval 259
Station Store 349
Store Points (GPS Offsets) 240
Store Points (GPS) 235
Store Points (TS Offsets) 232
Store Points (TS) 227
Store Sections 433
Supported File Formats 629
System Requirements 11

- T -

Template Editor 384
Text mode 245
Tolerances 199
TOOLS 563
Total Station (Pentax)
Total Station Prism Search by GPS 137
Transformation 351
Tutorial 1: Calculating a Traverse (By Hand) with SurvCE 578
Tutorial 2: Performing Math Functions in Carlson SurvCE Input Boxes 580
Tutorial 3: Performing a Compass Rule Adjustment 580
Tutorial 4: Defining Field Codes, Line/Layer Properties & GIS Prompting 585

Tutorial 5: Standard Procedures for Conducting GPS Localizations
603

- U -

Using the Manual 11

Utilities 389

- V -

VIEW 520

View Options 29

© Carlson Software, 2014
...Works Simply ...Simply Works
www.carlsonsw.com
